

ASSEMBLY

INSTRUCTIONS



ABOVE GROUND POOL

INDEX

1. SAFETY GUIDELINES	Page 3
2. ADVICES FOR A CORRECT STORAGE	Page 4
3. DETERMINING THE INSTALLATION SITE FOR THE POOL	Page 4
4. TOOLS	Page 5
5. COMPONENTS	Page 6
6. PREPARE THE AREA BEFORE THE INSTALLATION	Page 6
7. PLACEMENT OF THE LOW METAL GUIDES (M)	Page 7
8. ASSEMBLY OF THE STEEL WALL (CH)	Page 8
9. INSTALLATION OF THE WOODEN SLATS (LS)	Page 9
10. INSTALLATION OF THE LINER (L)	Page 11
11. INSTALLATION OF THE PLASTIC PROFILES (P)	Page 12
12. INSTALLING THE TOP CONNECTORS (EMB)	Page 13
13. LAST DETAILS	Page 14
14. INSTALLING THE RETURN VALVE (VR)	Page 14
15. INSTALLING THE SKIMMER(SK)	Page 15
16. MAINTENANCE OF THE WOOD	Page 15
17. MAINTENANCE OF THE SWIMMING POOL	Page 15
18. CARE DURING WINTER MONTHS	Page 17
19. TO EMPTY, DISASSEMBLE AND STORE YOUR POOL	Page 17
20. GUARANTEE AND CONDITIONS	Page 18



ATTENTION: READ THESE INSTRUCTIONS CAREFULLY BEFORE PROCEEDING TO ASSEMBLE YOUR SWIMMING POOL. REMIND ALL POOL USERS THAT THESE SAFETY INSTRUCTIONS MUST ALWAYS BE FOLLOWED-UP. KEEP THESE INSTRUCTIONS FOR FUTURE CONSULTATIONS. YOUR CHILDREN'S SAFETY DEPEND ON YOU! RISK IS HIGHER WHEN CHILDREN ARE UNDER 5 YEARS OLD. ACCIDENTS CAN HAPPEN TO EVERYBODY SO IF INSTRUCTIONS ARE NOT FOLLOWED MAY CAUSE HEALTH RISKS AND SPECIALLY IN CHILDREN!

1. SAFETY GUIDELINES



Remember that safety is the most important factor when installing the swimming pool. Safety must be given priority over any decorative aspect. Do not lean, jump, sit, stand or walk on profiles. They have not been designed to that effect.



Do not dive or jump headfirst in your swimming pool, do not jump from a ladder or elsewhere. This pool is not deep enough to dive without risk of accident. The self-adhesive sign "Unsupervised, your child in danger" must be placed close to or on your pool. For replacement adhesives, please contact our factory.



Do not use your swimming pool when being under the effects of alcohol, medicines or drugs. To avoid drowning and injuries, do not leave tables, chairs or other objects near the pool to prevent children from climbing into the pool.

Do not install a slide on your swimming pool.



To avoid electrocution risk, do not manipulate electrical equipment near to your swimming pool or with a wet body. Make sure that all electrical equipments are protected by a grounded switch.

When bathing, never use metallic or punching foot wear.



If your pool has a cover on, do not allow anybody, and specially small children, to walk or play on it.

Assign one entrance and exit for our swimming pool. This area must be kept totally clean. Remove all object that could hurt barefooted people.



Do not make holes in your swimming pool wall to install lights or any other devices. It could result in serious injuries, inundation, electrocution or property damage.



For more security, we recommend to install a 122 cms high fence or wall around your swimming pool made of a resistant material. All access doors/gates should have a lock installed at least at 122 cms high in order to prevent small children from opening them. If doors, windows and garden gates make part of the fence, make sure that they can be closed with a key or bolt.



Do not use your swimming pool at night or when visibility is not good. The water of your swimming pool should be always kept clean in order to see the bottom and appreciate its depth. Users should be capable to see that the pool is not deep enough to dive. If you decide not to take into account this safety instruction, then it's your responsibility to provide users the appropriate instructions on the correct use of this product and supply sufficient light. For lighting recommendations, consult your local licensed electrical contractor on the appropriate light so as to fulfil all local and national norms of electricity and other security requirements.



If your pool is equipped with a ladder, then follow-up all safety guidelines and assembly instructions indicated in the manual. A ladder must be used to get in and out of the swimming pool. When not in use, the ladder should always be removed and kept in an inaccessible place.



In order to maintain its stability, the ladder should be placed on a solid, levelled base at all times. Only one person at the time should be on the ladder.



Install the ladder where the entrance/exit of your swimming pool will be.

Never use your ladder for other aims. The pool ladder has not been developed for other applications.



If your swimming pool is equipped with a filter, make sure that the swimming pool is filled with water and your filter correctly connected as indicated in the manual.

During the bathing season, the filter must work every day, long enough to renew all the water at least one time.

Attention: All filter systems fulfill normative of installation NF C 15-100. It stipulates that all electrical item that is to less than 3,50 mts from the swimming pool and freely accessible, must be fed on very low tension. 12 volts.

All electrical item fed on 220 V must be place at least, at 3,50 mts from the pool's edge. A permission of the manufacturer is needed to modify any of the components of the filtration system.

Verify all parts of your pool on a frequent basis in order to detect possible failures and make sure all components are installed correctly. Always replace components with original spare parts.

This swimming pool has been designed for private use only. Do not use for commercial activities.

Avoid accidents and be prepared to react in case they occur!

2. ADVICES FOR A CORRECT STORAGE

The wooden slats that cover the pool have been treated with Autoclave IV. Nevertheless, the wood is a natural, noble and living material. It's very important to bear in mind its composition and the features of the product and to take basic precautionary measures, in order to obtain the greatest satisfaction.

Slight deformations (concave wood, convex in the sense of the length, knots....) won't make the assembly more difficult. Cracks and slight cracks are normal drying phenomena that don't make problematic the assembly or the guarantee.

While the pool is not assembled yet, it's sensitive to the temperature changes. It's necessary to have in mind the following advises, after receiving it:

1. If the pool is not assembled immediately:

- Storage the pool in a flat and ventilated surface, protected from important temperatura and humidity changes.
- The best thing would be to storage it with some weight on, so no piece will twist.

2. If the pool is immediately assembled:

- Remove the strip carefully, not to be injured by it when cutting..
- Assemble the structure within a 24 hours term.
- Don't assemble the pool in different stages, with a very hot weather and exposing the wood to the sun.
- Use appropriate tools.

IMPORTANT: We suggest you to use a brush to apply a water-based varnish (not included in the kit) in order to protect the wood from the weather's effects. Thereby, the wood will keep all properties that have been applied in the manufacturing process (autoclave and organic solvents).

We recommend to repeat the process at least once a year, to extend the life of the wood and improve its appearance.

3. DETERMINING THE INSTALLATION SITE FOR THE POOL

1. Take the time to read carefully the instructions before installing the pool. Follow all the steps.
2. This pools must be assembled on a firm, strong and levelled floor and outdoors.
3. This swimming pool has been conceived and designed to be easily installed. The final result will depend on the care and attention given to the assembly and if the instructions are followed, in order to increase the longevity of the pool.
4. Check local codes and be sure to get building permits, if necessary. Check electrical codes and local building codes regarding the installation of above ground pools.
5. Remember that your pool is like a big tank. If the pool was too full, the pressure against the wall could break it and release a big quantity of water. This could cause damages and injuries to the people that would be closet o the pool.
6. This kind of swimming pool contains big quantities of water and a significative weight. Take all the safety measures to avoid accidents. To calculate the approximate weight of your pool, please bear in mind that every liter of water is equivalent to a kilo.
- 6) Posición de los componentes de la piscina y comprobar las herramientas necesarias antes de comenzar la instalación.
- 7) At least 2 adults are required to assembly the pool.
- 8) The time to install the pool between 2 people is from 5 to 6 hours, depending on the model.

The swimming pool must only be installed above ground and on a hard, solid ground. The swimming pool must be installed near a drain or sewage system to avoid flooding in case of breakage/leakage.

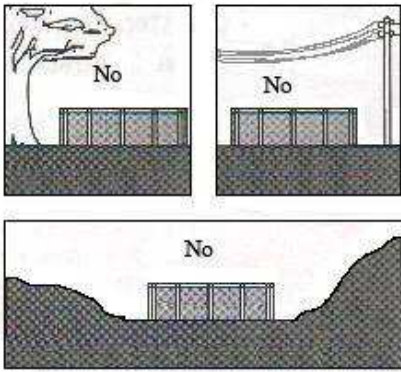

A large area is ideal. However, if a flat area, large enough for the swimming pool is not available, then choose an area where minimum digging is required. Under no circumstances, the swimming pool must be installed below ground level.

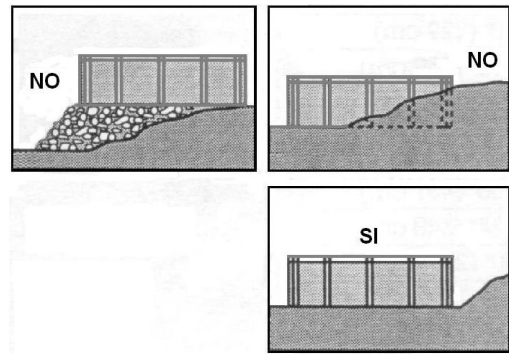

The maximum weight that the installation site can support must be taken into consideration.

Remove roots, grass and stones in the selected area, including those under the ground. The weight of the water will compress these elements between the liner and the earth under the swimming pool, resulting in damages. Grass left underneath the pool liner will rot and give of an unpleasant odour and stones and roots will damage the pool liner.

Do not install your swimming pool on: marshland, tar, gravel and wood. A foundation made of levelled, solid and very compact soil/earth is the best base for your swimming pool. Do not install your swimming pool on a fragile earth or on a site that will not support the weight of the pool.

ELECTRIC WIRES.

The swimming pool must be installed at a minimum distance of 6 meters from any electrical socket. To ensure maximum safety, it should never be installed directly below high voltage or medium voltage overhead electricity wires. In some communities, it is illegal to do so.

UNDERGROUND CABLES.

Check for any buried electrical, telephone cables, or gas pipes at the site before you start digging to level the surface.

TREES.

Overhanging trees and their tenants (birds, insects...) are not the swimming pools best friends. The resin and falling leaves and twigs can cause problems in maintaining your swimming pool's water clean. If there is a filtering system, it will have to be used more often. Install the swimming pool away from the trees.

GROUNDING SOCKETS.

In the case where the swimming pool has or uses a water filter or any other electrical device, and there is no grounded socket nearby, you must have one installed by an authorized electrical technician.



Important:

Determine the location of the swimming pool. **Make sure** that the distance with other near houses, fences...etc is the appropriate. **Check** that the ground is levelled. Contact the competent authorities to receive all the information concerning to the installation of the pool in his/her house.

4. TOOLS: (not included)

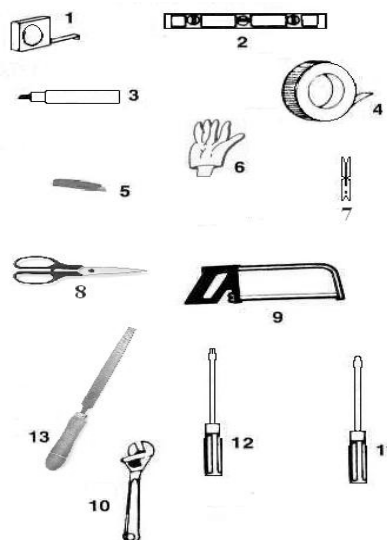

- 1.- A measuring tape
 - 2.- A spirit level
 - 3.- A marker (felt pen)
 - 4.- Adhesive tape
 - 5.- Cutter
 - 6.- Gloves
 - 7.- Clothespins
 - 8.- Scissors
 - 9.- Metal saw
 - 10.- A wrench
 - 11.- A flat screwdriver
 - 12.- A star screwdriver
 - 13.- File
- (A rake, a stake and a rope)

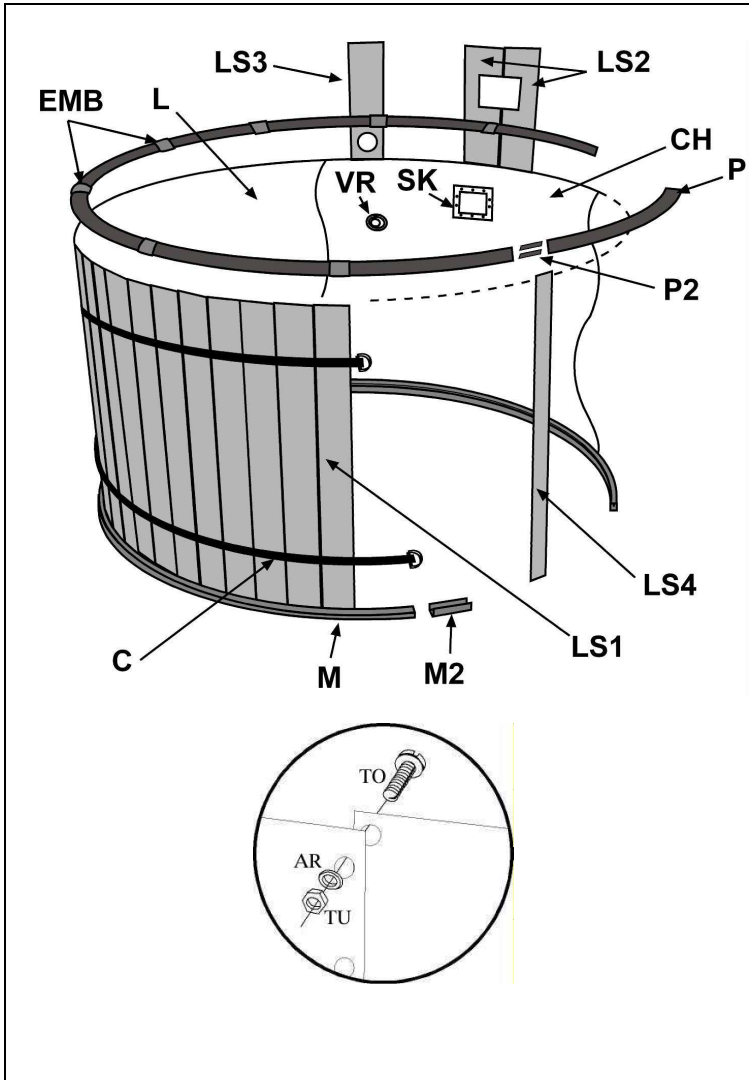

5. PART LIST (COMPONENTS)

COMPONENTS: Remove and sort the components of the pool before starting installation

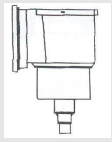

	Ø 350x120	Ø 460x120	Ø 550x120
L	1	1	1
CH	1	1	1
TO	31	31	31
AR	31	31	31
TU	31	31	31
M	10	12	15
M2	10	12	15
LS1	86	116	139
LS2	2	2	2
LS3	1	1	1
LS4	1	-	-
P	10	12	15
EMB	10	12	15
P2	20	24	30
C	2	2	2
 SK	1	1	1
 VR	1	1	1

6. PREPARE THE AREA BEFORE THE INSTALLATION

For this kind of pool we recommend to make a concrete platform. This platform should have the same size as the pool diameter plus 30 cm. security. The surface must be **TOTALLY HORIZONTAL, WITHOUT DIFFERENCE.**

VERY IMPORTANT: Never assemble the pool on polystyrene plates or similar.

- We recommend to put on the ground a protective sheet, a rot-proof tapestry or Astroturf, to protect the liner from breaks caused by the fret of the liner with the floor.

- Directly on the area, previously conditioned (see instructions here below), you will need the following tools:

A stake, a rope, a funnel (bottle), and some lime, flour or similar. Mark the area where the pool will be placed. For major security, use gloves.

- Hammer a peg in the ground; in the center of the area where you want your pool. Tie a string/rope to the peg equal to the length of the radius of the swimming pool +30 cm, and mark a circle with a chalk or with a bit of lime or flour and a funne (or bottle) (fig.1).

- If you need to level the floor, don't fill in the holes. Dig away higher areas and level the ground with lower areas (not the other way round). Anyway, it's needed to remove roots, grass, stones, twigs... and any kind of sharp objects (fig. 2 y 3)

- Level the ground with a rake or a table, covering the holes with sand (fig. 4).

- Keep on checking that the ground is levelled 100%, with a spirit level and a flat strip of wood. Level all the surface in the same level tan the lowest place, filling in with fine sand. Level again. (fig. 5).

- And finally, place a thin layer of sieved sand throughout the surface. Spread the sand with a table and level it at the same time. Flatten the area with a roller (fig. 6).

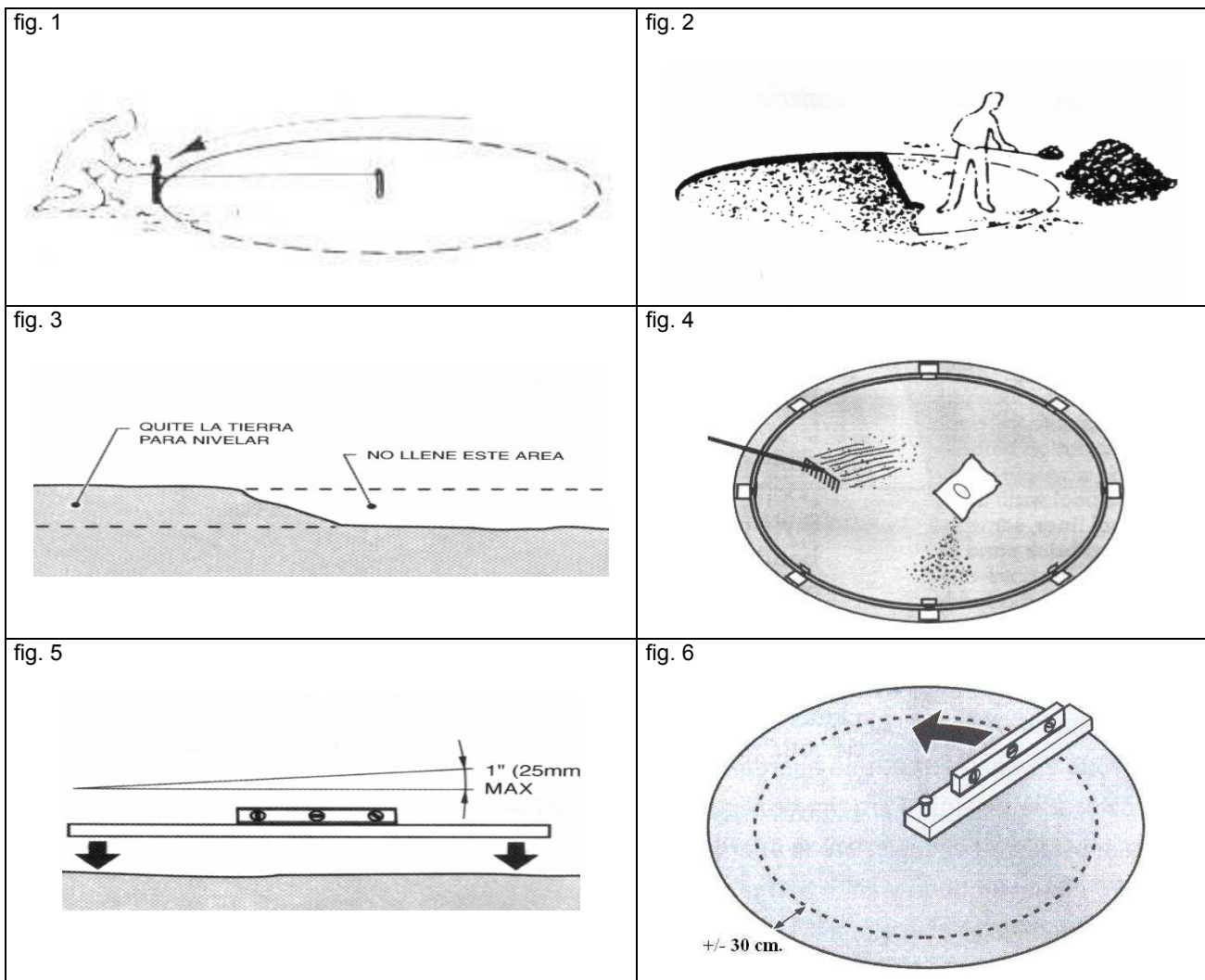

7. PLACEMENT OF THE LOW METAL GUIDES (M)

Make a platform 30 cm. more (approx) than the measure of your pool, so this will give you a safety margin. Locate the center of the platform (on the central point), tie the rope equal to the length of the radius of the pool (+30 cm) and mark a circumference with chalk, lime or flour and a funnel (fig.1).

a) Put the metal guides (M) around the circle (previously marked) and link the guides with the union pieces (M2) as the below pictures show. At the end, make sure that the circle is not deformed (fig. 7).

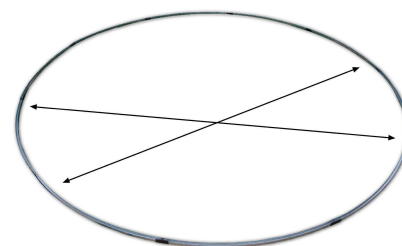
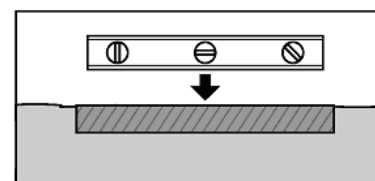
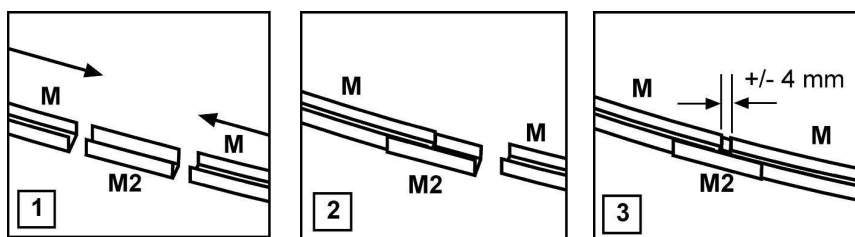

fig. 7

Advice: Leave a gap between the guides of aprox. 4 mm. This will allow you to close the steel wall (CH) easily. .

8. ASSEMBLY OF THE STEEL WALL (CH)

VERY IMPORTANT: Don't fold or wrinkle the steel wall during the installation. Unfold it very carefully. Put a cardboard under the metal wall in order to unfold it easily and avoid it to be scratched with the floor contact (possible cause of rust).

Installation must be done by at least 2 people, on a sunny day and with no wind. During the installation, don't fold the metal wall and handle it very carefully.

Don't unfold neither break the lower or upper guides during the pool assembly.



Very important: Please wear gloves during the pools assembly, to avoid cuts with the metal hedges.

a) Unpack the coiled pool wall (CH) and place it vertically (the inner wall sticker up) on a cardboard at the center of the pool circle. This will help you to unroll it easily and make sure that it doesn't get scratched by rubbing against the ground (fig. 8).

Fig. 8

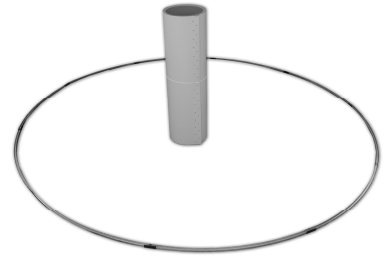

IMPORTANT: EL TROQUELADO DEL SKIMMER ESTÁ AL FINAL DEL ROLLO DE LA PARED DE ACERO Y DEBE DE QUEDAR EN LA PARTE SUPERIOR DE LA PISCINA.

b) Start unrolling the wall, placing the bottom corner of the wall in the low metal guide (M) (fig. 9).

Fig. 9

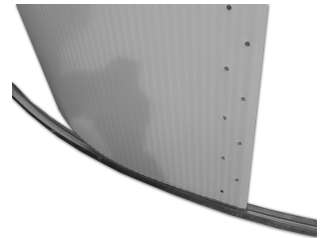

b) Unfold the metal wall, following the circle till the wall will be assembled inside the low metal guides (M). (fig. 10)

Fig.10

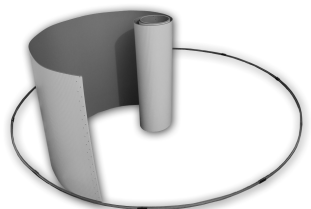

c) Join the two ends of the metal wall so that the screws (TO) can pass inside both holes, leaving the nuts (TU) and the washers (AR) at the outer side (fig. 11).

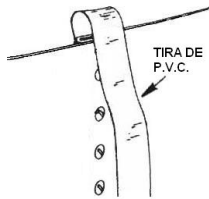

Cover the ends of the junction and the wall boards (inside of the pool) as well as the screws, with the PVC tape in order to protect the liner from the contact with this objects, that may cause breaks in it. The PVC tape must be firmly stuck in this area and if it was necessary, use adhesive tape or similar to fix it to the wall.

Very important: Put all the screws in the metal wall, from the bottom up, excepting the last hole. Tighten strongly, all the screws with screwdriver. If the assembly and the fixation of screws and nuts is not correct, the guarantee of the pool could be canceled.

Install the plastic profile (PL) around all the perimeter of the pool. Cut the excess of the last section of the profile (PL) to fit perfectly. Be very careful not to damage the liner.

Before installing the wood slats, cut the skimmer hole with a pair of scissors for metal.

Smooth the edges to avoid the liner to be damaged or cut.

Fig.11

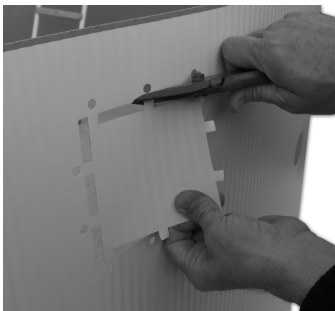
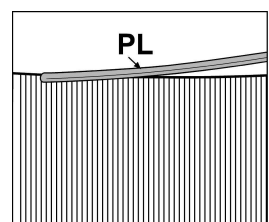

Fig. 12



9. INSTALLATION OF THE WOODEN SLATS (LS1- LS2- LS3- LS4)



Put the textile tape (C) around the steel wall and adjust it in order for it to remain on the top of the pool (30 cm from the top approx.).

To tighten the tape, please follow these steps:

- 1- Thread one end inside the two rings and tighten to adjust the belt to the wall.
- 2- Take the end of the tape and wipe inside the second ring as shown in the second image.
- 3- Pull the end you just entered and finally adjust the tape to the band in order for it not to fall.



Don't tighten the textile tape too much now as the steel wall could be deformed. It's enough for it to remain hold.

To place the wood slats is very simple. Separate the tape with a hand and introduce the slats between the tape and the wall, from top to bottom (fig.13), by sliding it until it snaps into the bottom guidewire (fig.14)

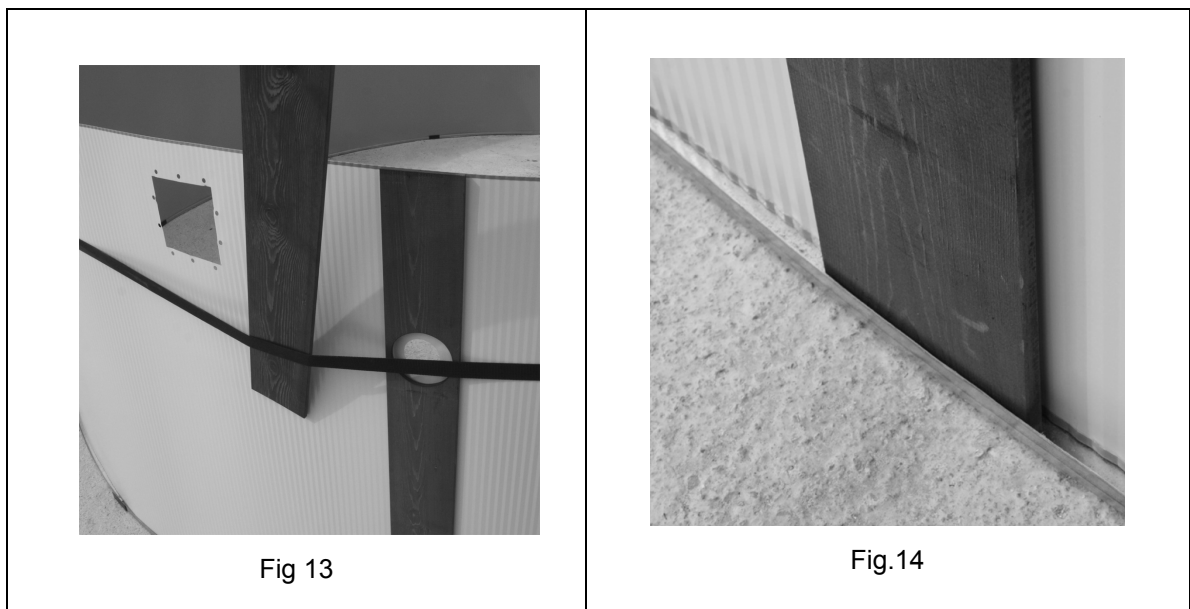

Make sure that the slats are well positioned and introduced correctly in the low metal guide (fig. 14) in order that they remain aligned with the top part of the steel sheet. The picture 15 shows how a wrong assembly and a correct one.

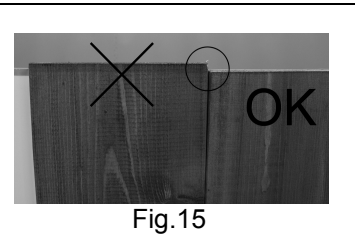

Place the slats one after another, **without joining them completely**. Leave a gap of approx. 1-2 mm between them. In this way the movements of the wood (due to the humidity) will be absorbed (fig 16).

a. Start assembling the slats that go in the valve zone (LS3) and in the skimmer (LS2). Introduce the low part of the slat (LS3) between the wall and the tape, by matching the hole in the wall with the one in the wood slat.

b. Place 2 slats (LS1) towards the skimmer hole in the way you put the slat in the valve zone (LS3).

c. y d. Adjust now the 2 slats for the hole in the skimmer (LS2) by matching the hole in the steel wall with the hole in the slats. Adjust the slats that have just been put to center the holes in the woods with the holes in the steel sheet. In this case, the skimmer will match perfectly.

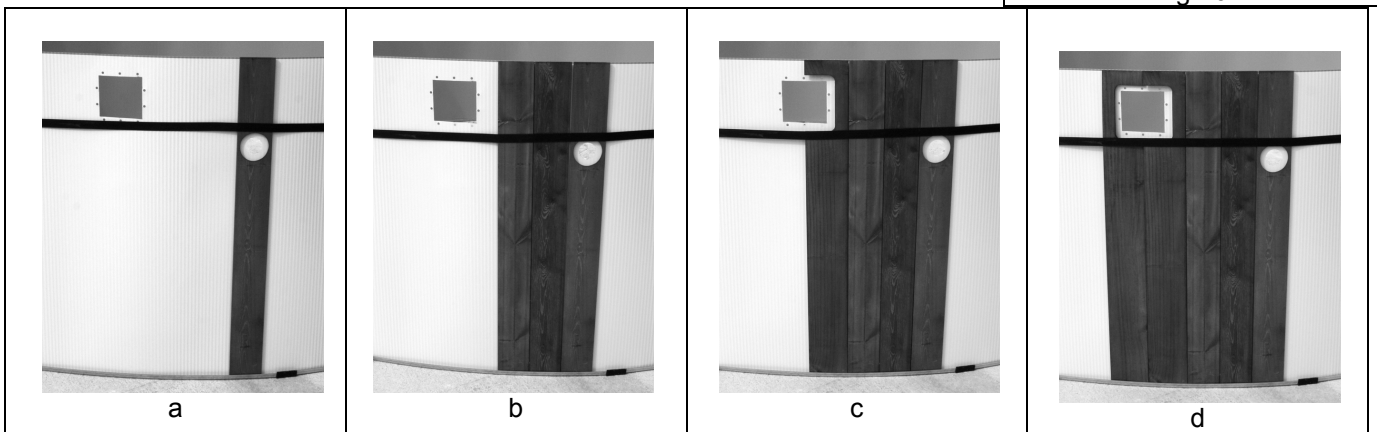

Put the rest of the slats (LS1) around the pool, leaving the wood slat (LS4), that is narrowest than the other slats (LS1), to the end. (Note: LS4 is only for the pools with size 3,50). A slight gap between the slats must be left while assembling them.

ADVICE: If there is a gap between the slats LS1 when you have finished putting all of them, distribute this gap between all joints of the slats in order to hide the link. This has been done on purpose for the holes to absorb the natural movements of the wood, due to the changes of temperature and humidity.

Place the other textile tape around the pool at aprox. 30 cm from the bottom of the pool and tighten it. You can make a knot in the end of the tape to ensure that it won't be loosened over time.

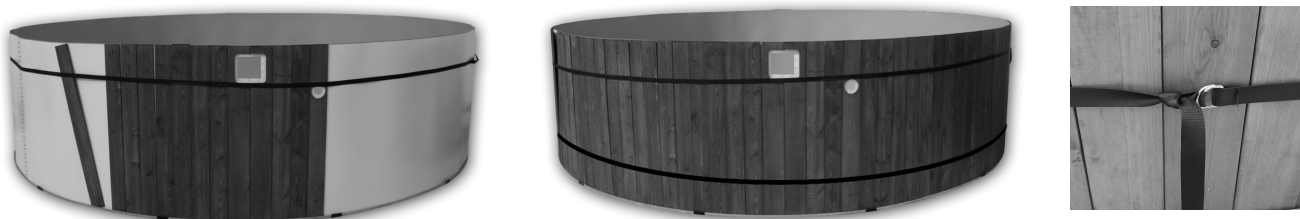

At this point, make sure that the pool is round before start the following step (fig. 18). Check the guides make a perfect circle and it adapts to the circumference, previously marked (7. PLACEMENT OF THE LOW METAL GUIDES).

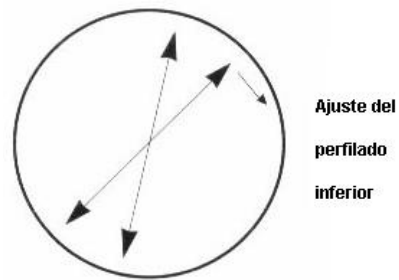

fig. 18

Before the liner's installation, place a protective floor cover or put a sieved and thin sand layer (without stones) on the inner area with a thickness of 5 cm. Use a rake to ensure that the sand layer doesn't have slopes (fig. 19).

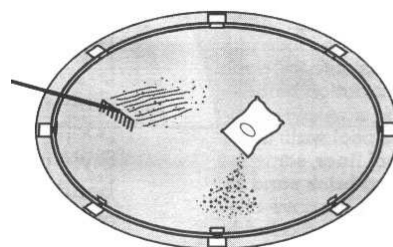

fig.19

Important: Once the floor cover or the sand layer have been put, put more clean sand (without any stone or strange objects) creating a triangular chock of 20 cm. base and 20 cm height. In this way we'll avoid that the water pressure damage or slide the liner under the wall, and the water forces will be distributed uniformly (fig. 20). Before installing the liner, we recommend to put a plastic carpet (a blanket, or astroturf) between the sand and the liner, to give more protection to the liner.

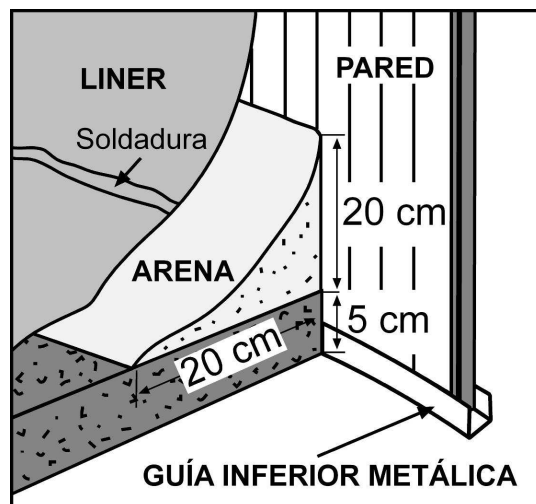

fig. 20

10. INSTALLATION OF THE PVC LINING (LINER) (L)

Important: Install the liner between 2 (or more) people. The PVC used for our liners has been developed to withstand exposure to heat and ultraviolet rays for a long period of time. Therefore, under certain climates and conditions of use, the liner quality can vary slightly.

Never walk on the liner with your shoes on. Don't put tools or pieces on the liner. Any cut or damage produced by a wrong handling will cancel the liner's guarantee (See "Liner's guarantees").

The liner is the most important and delicate part of the swimming pool. Don't use knives or any sharp object to open the swimming pool bag/container. Carefully separate the liner from the rest of the parts and keep it in a safe place to avoid undesired holes or damages that could be caused by the tools or the metal wall.

Install the liner on a sunny day, minimum at 20°C, so that can easily stretch during the installation. It's made of a highly flexible vinyl material, sensitive to the heat so it must be warm when installed in the swimming pool.

a) Place the liner (L) in the center of the swimming pool and unfold it towards the sides (place the rough side towards the upside and the flat side down). The welded part that joins the base of the liner to the side of the pool must perfectly aligned and match the low profiles of the pool (fig.21), all around the inside perimeter at the bottom of the swimming pool.

b) Locate the side welding (SL) so that it's perfectly right and perpendicular to the ground. This will help you to place the liner without folds. Pull away softly all the excess of the liner and don't pull it too hard. The liner must be centered, well extended and not wrinkled. Cover the upper edges of the pool (the steel wall and the wooden slats) with clothespins (fig. 22). Remove the excess

c) To remove the excess of wrinkles in the base, don't wear shoes, and extend the liner towards the sides with your hands and feet. Flatten the liner and start filling the pool with water, but no more than 2 cm approx. Take the time to do it properly and for the liner to be free of wrinkles.

d) Once the base hasn't got any wrinkle, ADD MORE WATER (approx.10 cm under the the hole of the return valve). **DON'T FILL COMPLETELY THE POOL YET.** While the pool is getting full of water, stretch the sides of the pool up to tighten it the most. The water pressure will fix the liner to the wall.

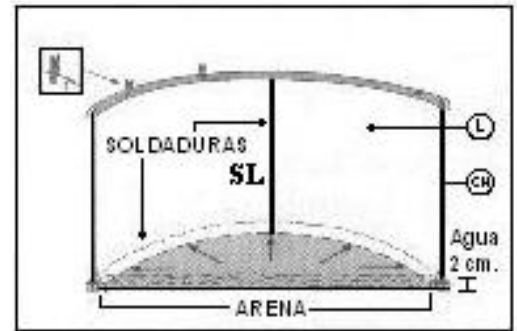

fig. 21



fig. 22

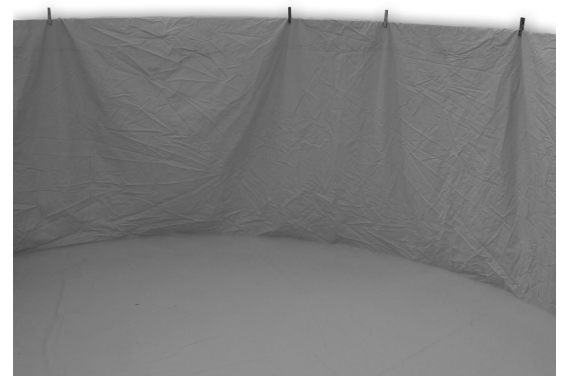

fig. 23

IMPORTANT:

CHECK THE WATER DISTRIBUTES EQUALLY. If there were any puddles, that means that the ground has hollows. If the water accumulates in a side, is that the area is unbalanced. IN THIS CASE, THE POOL MUST BE EMPTIED AND DISASSEMBLED COMPLETELY TO START SINCE THE BEGINNING, WHEN THE GROUND HAVE TO BE WELL LEVELLED.

11. INSTALLATION OF THE PLASTIC PROFILES (P)

1- The plastic profiles (P) are linked together by the connecting pipes (P2). Take a profile and insert two connecting tubes (P2) by the end of the profile. Enter the tubes half way. Take another profile and press the 2 profiles strongly (fig. 24)

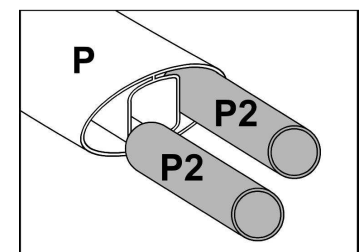

fig. 24

2- Place the 2 profiles (already linked) against the metallic guide (M) that holds the wooden slats and make it match the joint of the metal guides (shown in the picture Fig. 25 with an arrow) with the center of the plastic profile (P). This will make the link more solid.

3- Press down starting at one end of the plastic profile (P) (fig. 26). In this way, it will be easy to match the profile, because it's been designed to fit with some pressure (so, inserting it at the same time would be more difficult). Follow the same process for the rest of the plastic profiles, joining the profiles between them as in the 1st step. Don't put the last section yet.

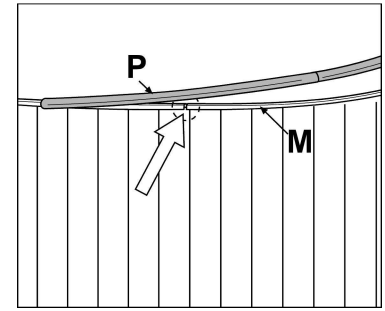

fig.25

Before placing the last section, check that all profiles are perfectly fixed between them. Place the last profile in its position to close the circle and mark where the excess of profile will be cut (in order for it to match perfectly). It's better to cut twice to fix it better, than to cut too much and not match it properly (fig.27)

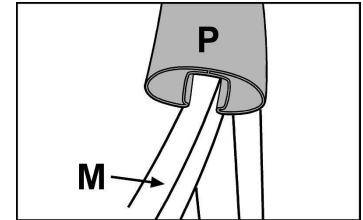

fig. 26

Once the last section has been cut, lift slightly the profiles that are already placed in the pool; put the union tubes (P2) in the last section and link it to the plastic profile, already placed (P). Push down slightly to adjust the profiles (P) to the metal guides (M).

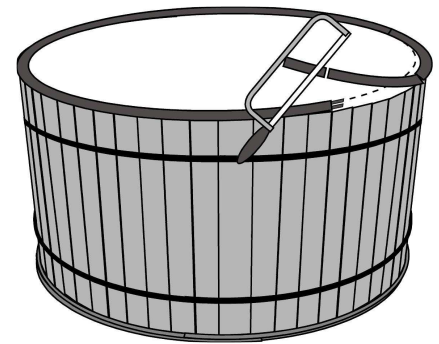

fig. 27

12. INSTALLING THE TOP CONNECTORS (EMB)



- 1- Place the top connector in the middle of the union of the profiles.
- 2- Open it slightly with the hand and first, hook it on the inside of the pool and then set it to the profile.
- 3- Repeat the operation with the other top connectors.

13. LAST DETAILS

Once all profiles and top connectors have been placed, you can cut the excess of the liner (that goes out below the metal guides). Use a pair of scissors or a blade to do it. Pull the end of the liner and cut it carefully, as it's shown in the picture (fig. 28).



fig. 28

Put "advises adhesive" in a visible place (i.e. close to the ladder). Figs. 29, 30.



fig. 29

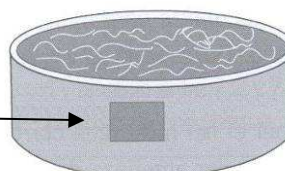

fig. 30

- Assembly the ladder following the instructions and place the sticker it in a visible place, in the entry/exit way of the pool. Remove it after using it.

- Assembly the filter equipment following the instructions of its manual. It must be placed (as min.) 3,5 meters far from the pool, once plugged and connected to it by the hoses.

14. INSTALLING THE RETURN VALVE (VR)

The return valve is the item through which the water returns to the pool, after having been filtered in the filter equipment (fig. 35). **Important:** Put Teflon in all threads. **The excess of Teflon can cause breaks of the pieces.**

Remove the rear fitting of the return valve and put Teflon, then screw it until the end.

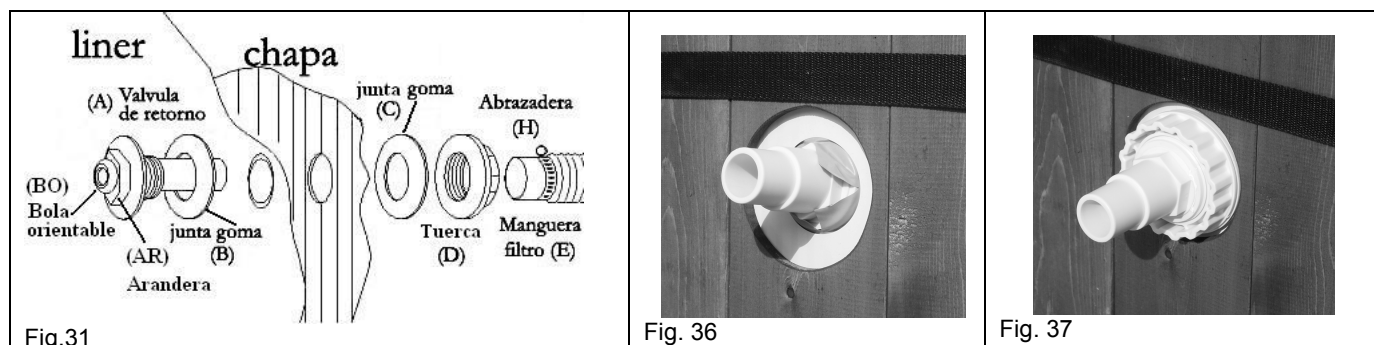

1) Once the water reaches +/-10 cm under the bottom edge of the valve, mark a cross in the hole (in the liner) with a felt pen. Cut with a blade, from the inside to the outside, very carefully and make the cross without exceeding the hole. Place the rubber washer (B) on the steerable grid (A) and introduce it into the hole, inside the pool (Fig. 36). From the inside to the outside, cut the piece of the liner that exceeds on the outside.

2) Place the rubber joint (C) out of the pool. Put Teflon on the threads and firmly tighten the nut (D) (fig. 37). Put Teflon and insert the return hose (E), that runs from the from the outlet of the filter to the return valve (A), and secure it with the clamp (H).

For the best filtration, we suggest you to orientate the jet of the water, so the washer/ring (AR). Move the adjustable ball (BO) towards one of the sides of the pool and slightly down and then, fasten the ring (AR). In this way, the impurities will be directed to the skimmer and the water will circulate throughout the pool.

15. INSTALLING THE SKIMMER (SK)

Once the water of the swimming pool is +/- 5 cm under the skimmer hole, mark the hole in the liner with a felt pen and cut the skimmer's square with a sharp blade the piece of marked liner (fig. 36).

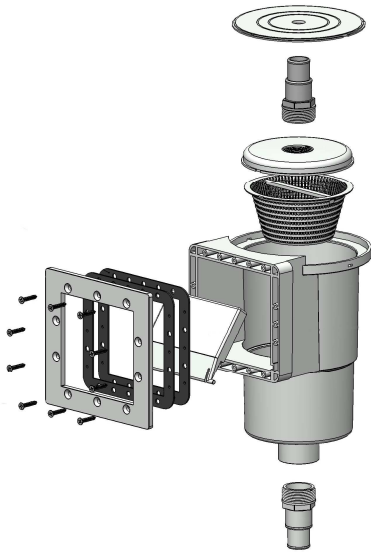

Cover the "racor" (R) with Teflon and screw tightly the connectin screw to the skimmer's body. It's important to put Teflon in all the connection threads to ensure the sealing. **The excess of Teflon may cause the break of the pieces.**

To put the skimmer, start by placing the rubber gaskets one on each side (fig. 37). Put the frame on the inside of the pool and insert a screw in the top central hole in order to cross the **frame + rubber gasket + liner + the other rubber gasket + skimmer's body**, from the inside to the outside. Screw a little bit to hold it to the skimmer's body (Figs. 38 y 39).

Repeat this operation in the bottom central hole. Screw slightly and put the rest of the screws one after another, following the indicated order.



fig.36

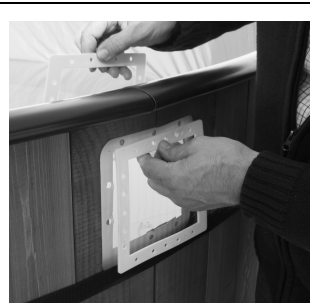

fig.37

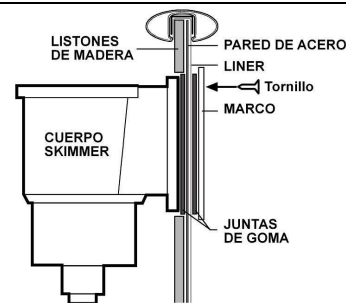

fig.38



fig.39



Conect the end of the hose to the connection thread with a clamp. Fit the other end of the hose to the inlet of the filter equipment and tighten with the help of a clamp.

Finally, place the basket inside the skimmer and close the skimmer's body with the cover.

To finish, fill the pool a little more than half of the skimmer's gate to get water inside and fill the filter system.

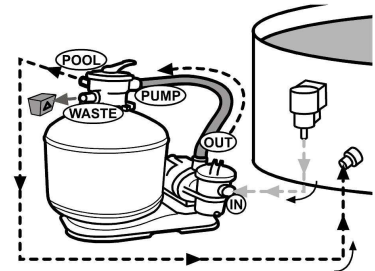

16. MAINTENANCE OF THE WOOD

To keep the wood all the properties that have been applied in the manufacturing process (Autoclave and organic solvent), we suggest you to use a brush to apply water barnish in order to protect the wood from the weather changes (not included in the kit).

We recommend to repeat the process at least once a year, to extend the life and improve the appearance of the wood.

17. MAINTENANCE OF THE SWIMMING POOL

- WATER MAINTENANCE

All swimming pools need chemical treatment to maintain the water disinfected and crystal clear. Consult your chemical products supplier to determine those that are best for your needs. Water treatment procedure is not the same in all regions, because it depends on the water quality in each region.

WARNING: An incorrect treatment may cause water pollution that produces infections, poisonings and diseases.

The best water quality is obtained by using the right preventive treatment. To prevent the growth of algae and bacteria, use bactericide, algaecide, water pH correctors and flocculants (except for cartridge filters). Apply the first chlorine treatment within 24 hours of filling the pool.

Never add chemical products directly to the water. Chemicals must be diluted before being introduced into the water. Otherwise, the liner could be damaged. However, it is easier to keep the water clean than to clean contaminated water. Use your filter frequently.

Water maintenance is the most important factor in making your pool liner look excellent and last for a long time. Therefore, follow the instructions in the filter manual. The filter capacity must be high enough to filter the water of the pool 3 times in every 24 hours. The filter must be connected when there is nobody in the pool.

Make sure to check the water at least once a week, to keep the pool in optimum conditions.

Make sure that you do the following on frequent basis:

- Analyze the water pH and make sure it is between 7.2 and 7.6.
- Analyze the chlorine level and make sure it is between 0.5 and 2 grams per cubic meter.
- Remove any leaves and insects from the water.

Make sure that you do the following on weekly basis:

- Add the correct "maintenance quantity" of algaecide.
- Add anticalcareous if lime is formed or the water is hard.
- Use flocculants to improve filtering (except when using a cartridge filter).

- HANDLING CHEMICAL PRODUCTS AND SAFETY MEASURES

The following precautions must be taken when handling chemical products:

- Use gloves to protect your hands and masks or goggles for eye protection.
- No smoking where the products are stored or used. Many products are flammable.
- Wash your hands and face after using the products.
- Store the products in a dark and dry place. Do not leave the products in the sun.
- Make sure that the containers are closed. Tighten their caps or lids.
- Do not leave the products within the reach of children. Make sure that the products are stored in a high and safe place.
- Do not reuse the empty containers.
- Keep the products in their original containers.
- Do not remove the labels from the containers.
- Make sure that the storage area for chemical products has proper ventilation.
- When raining, increase the level of chlor and antialgae-bactericide.
- When adding water in the pool, check again the chlor and antialgae-bactericide level.
- Well ventilate the place where the chemical products are stored.

- POOL MAINTENANCE

After your pool has been completely installed, follow these instructions to keep it clean and in good condition.

- Liner – Regularly check for leaks in the liner. Use the repair kit for small repairs on the liner.

- Pool wall – Keep it clean, using a neutral soap. Do not use abrasives, chemicals or cleaning solutions.

Clean up silt chemical products, used for water treatment, right away. Coat all showing screw heads with clear outdoor varnish.

Check the metal parts for rust, at least once a year. Coat all scratches and rusted areas with an anti-rust paint. Follow the instructions for paint application.

At the end of the season, drain the water until the water level is 30 cm. Remove the upper part of the liner and check for possible rust on the inner side of the pool wall.

Pay special attention to leaks in the filter and outlet holes. Leaks must be repaired right away.

Shock chloration

It destroys quickly and efficiently all microorganisms, bacteria and fungi, if chlore level is raised up to 20 ppm aprox.

Shock chloration is recommended in the following cases:

- a) At the beginning of bath season.
- b) Depending on special climatic conditions (storms, rain...).
- c) In case of intensive use of the swimming pool.

Cleaning the bottom of the swimming pool by aspirating: only for pools with skimmer and filter with engines 6, 8, 10 y 15 m³. Connect the end of the hose to the brush and immerse it in the water for the hose to get filled up. Connect the other end of the hose to the aspiration cover and put it on the basket of the skimmer. Start the filter system in "drain off" and start cleaning the bottom.

Cleaning the bottom of the pool with a ventury: Connect a hose to the head of the ventury and immerse it in the swimming pool. Open the tap with a normal pressure and the ventury will start working. The water bounces on the ground producing an updraft that collects and deposits the dirt inside the filter-bag.

Problems	Causes	Solutions
Turbid water	Poor filtration. High pH. Excess of organic residues.	To do a counterwash of the filter. Add flocculating agent with a dosificator. Make a shock chloration, except in cartridge filters.
Green water	Algae formation.	Brush the bottom and the pool's wall. Analyse pH and adjust between 7,2 and 7,6. Make a shock chloration and add extra antialgae.
Brown water	Presence of iron and manganese.	Analyse pH and adjust between 7,2 and 7,6. Make a shock chloration
Inlays	Calcic of the water.	Analyse pH and adjust between 7,2 y 7,6. Add anti-calcareous once a week.
Eyes and skin irritation	pH disarranged. Excess of organic residues.	Analyse pH and adjust between 7,2 y 7,6. Make a shock chloration.

18. CARE DURING WINTER MONTHS

If the pool is not disassembled during the winter, compliment following instructions at the end of the season to prepare your swimming pool for the winter. During wintering, do not drain all the water. Never leave a swimming pool dry outside. Decrease the water level just below the skimmer opening. Cover the pool with a cover. To keep the cover flat, place an inflatable object or floater between the water and the cover. This way, the liner is not damaged by rain and/or freezing. You can also add a chemical product to the water in order to protect the liner against freezing. This product also facilitates the cleaning of the liner after the winter time.

To avoid that the water starts freezing, let several empty plastic bottles (or balls made of Porespan) float on the water. In case of snow, remove the snow of the cover regularly so as to avoid extra weight on the cover.

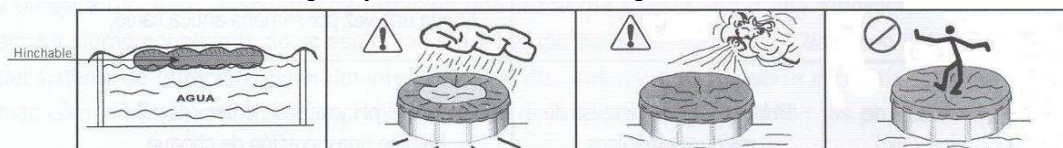

- Check all points and screws and that all joints are correctly adjusted. Check that the pool wall has not come out of the lower profiles. Check the screws are tight.
- Check rusted areas and paint all scratches or rusted areas using anti-rust paint.
- Check liner. Check that the upper part of the liner is still joined to the pool wall with plastic copings. DO NOT remove the pool liner. Removal of the liner shall void the product warrantee and/or guaranty.
- Find any leaks. Check that there are no leaks in the liner. Leaks can cause great damage to your pool during the winter.
- Pool accessories. Remove all accessories, including the ladder, from the pool. Wash the ladder with water and neutral soap. Wash the rest of the accessories with water and neutral soap.
- Filter. Remove the filter from the pool. Wash the whole filter with water and neutral soap. Read the filter installation and maintenance manual.

19. TO EMPTY, DISASSEMBLE AND STORE YOUR POOL

If the pool is disassembled during the winter, empty the pool with the filter till the return valve level and then use "the communicating vessels principle". For this purpose submerge a hose in the pool until it's full of water, then, cover on end with your hand and take it out of the pool. Water will start to come out. Make sure to keep the other end of the hose submerged to empty the pool.

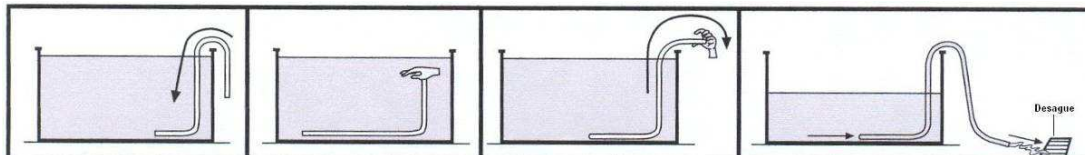

Once the pool has been emptied, disassemble it carefully in the inverse sense in which it had been assembled, in order not to damage or deform the pool. Check all pieces are clean and dry them before storage.

Before store the liner, clean it with water and neutral soap. Don't use abrasive products, remove all impurities and dry it with a cloth or absorbent paper. This will help to keep the liner in the best conditions and avoid bad odours and humidity. Fold it and store it in a dry place, protected from the sun.

In case you have any broken component/s, replace it/them as soon as possible, using original accessories



GARANTÍA ▣ GARANZÍA ▣ GARANTIE ▣ GUARANTEE ▣ GARANTÍA

GENERAL ASPECTS

In agreement with these regulations, the seller guarantees that the product of our brand (mark) corresponding to this guarantee does not present any lack of conformity in the moment of its delivery.

The guarantee period for the product is 2 years (except for the liner), counted since the moment of delivery.

If a lack of conformity took place and the buyer was notified during the guarantee period, the seller will have to repair or replace the product to the buyer in the place where he/she will consider although it was impossible or disproportionate.

When the product can't be repaired the buyer may ask for a proportional reduction of the price or, if the lack of conformity is enough important, the resolution of the sales contract could be also asked.

The replaced or repaired parts under guarantee don't extend the guarantee's term of the original product, but will have their own guarantee.

For the effectiveness of this guarantee, the buyer must prove the date of the purchase and the delivery of the product.

After 6 months of the delivery of the product and there was a lack of conformity, the buyer must prove the origin and the existence of the alleged defect.

This warranty certificate does not limit or prejudice the rights corresponding to consumers under national mandatory rules.

PARTICULAR CONDITIONS

This guarantee covers the products referred to in this manual.

This certificate of warranty shall apply only in the countries of the European Union.

For the effectiveness of this warranty, the purchaser must strictly follow the manufacturer's instructions included in the document accompanying this product when this is applicable according to the range and the model of the product.

When a calendar is specified for the substitution, maintenance or cleanliness of certain pieces or components of the product, the guarantee will only be effective when the above mentioned calendar has been followed correctly.

LIMITATIONS

This warranty shall apply only to sales made to consumers, understanding the consumer as the person that acquires the product with ends/purposes that don't enter the area of his professional activity.

No guarantee is given respect the normal wear and tear of the product. Regarding the pieces, components and/or consumables (as batteries, bulbs...) will be as provided in documentation accompanying the product.

The guarantee doesn't cover those cases in which the product: 1/ has been object of an incorrect treatment. 2/ has been repaired, handled or maintained by a non authorized person (expert). 3/ has been repaired or supported with not original pieces.

When the lack of conformity of the product has been a consequence of an incorrect assembly or a wrong starting, this guarantee only will work if the assembly and starting have been included in the contract of sale and purchase and under the responsibility of the seller.

SWIMMING POOLS – GUARANTEE’S CONDITIONS

Components	Guarantee	Loss of Guarantee
Liner	The Guarantee covers any fault of manufacturing of welds for 1 year. These faults, if existing, appear a little time after having assembled the pool. Within 15 days after assembly, the Guarantee stops having effect, as the conservation of the liner depends on the use that the buyer gives to it.	Pricks or pores in the surface of the liner, produced by wrong handling while assembling the pool, unpacking or incorrect storage voids warranty. Use of chemical aggressive chemical products (like sulfaman, or solid chlorine) voids Guarantee. In case of disassembly to reassemble the swimming pool in another place, the following year also voids warranty
Metallic Band	The Guarantee covers 2 years against any fault of fabrication, as well as the oxide. The metallic band has to be assembled as per the Manual of Instructions, putting all pieces, screws and iron-works in place.	To bury the swimming pool even partially, totally cancels the Guarantee, because these pools are designed to be assembled above ground only. Paint or use of Chemicals products on the Metallica band, or use of corrosive products to clean the pool’s surroundings, voids the Guarantee against oxide.
Filter System	The Guarantee covers for 1 year against any fault of manufacturing. The assembly and maintenance of the filter system will have to be done as the Manual of Instructions shows.	The “muffle”, produced by plants/tree’s leaves, because of bad cleanliness of the pool, as well as the use of acid products, cancels the Guarantee. If the pump has been handled and/or manipulated by non qualified people the Guarantee is void. Pump damage, produced by making it work dry voids Guarantee The Guarantee is annulled if instructions of electric installation aren’t followed scrupulously.
Decoh!pool	The Guarantee of the Decoh! Pool cover is only 6 months against any fault of fabrication. The Guarantee of Decoh!pool covers the loss of the colour during 1 summer because this is a biodegradable product; sensitive to the solar radiation (which varies, according to the pool’s location).	Cuts and tears , produced during the assembly and discolouration produced by spillage of chemical products are not covered by the Guarantee. The guarantee does not cover the use of this article on any other pools but pools.
Winter Cover	The Guarantee covers 1 year against any fault of manufacture	Breaks produced by atmospheric inclemency. Incorrect dimensions provided by purchaser.

GENERAL EXCLUSION OF THE GUARANTEE

The Guarantee won’t have effect in the following cases:

- When breakdowns or damages have been produced by an **incorrect use, assembly or bad handling of the product.**
- When damages to the product are produced by **natural catastrophes, casual events or major force.**

In case there is any incident, remember:

- it is important to keep and supply the **Purchase receipt should an issue arise.**
- Also, it is important to give the **Lot nº** (inside the package).
- If you see that the package is damaged or spoilt, when the pool is received, you must write an “observation” in the Proof of Delivery, although damages can’t be checked until after unpacking.
- If the presence of a specialized technician is required to solve the problem, and they see that the problem has been caused by bad handling or assembly by the buyer, the expenses will fall to the customer’s account, NOT the company.

