



**BSVillage**  
PISCINE - WELLNESS - OUTDOOR

MANUALE di MONTAGGIO  
**Piscina in Legno**  
**EcoWood 470**







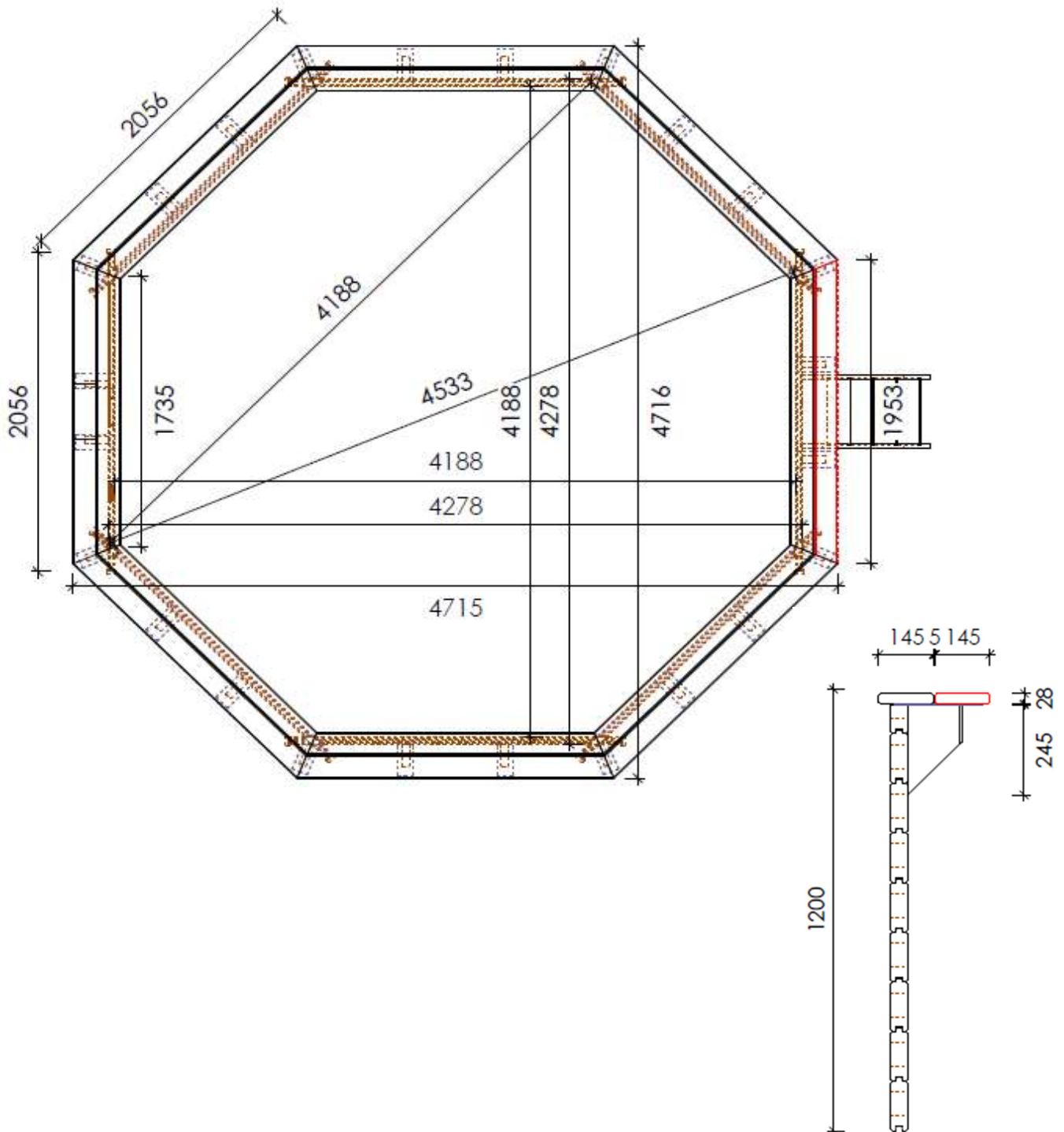
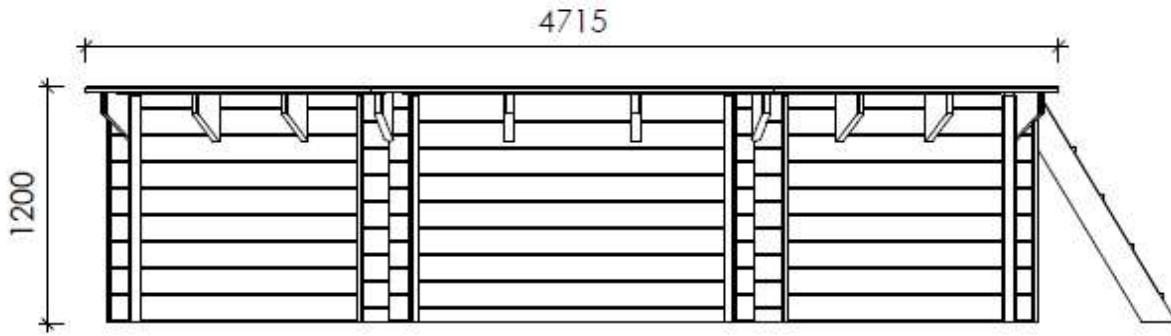























[www.bsvillage.com](http://www.bsvillage.com)

**BAS53-2 510cm h120cm  
44(+/-1)mm**

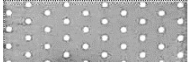

## BAS53-2 510cm h120cm

Nr	Element	Size			pcs	A	B
		d	h	L			
1		28	145	1953	<b>7</b>		
2		28	145	1829	<b>8</b>		
3		28	145	800	<b>2</b>		
4		28	145	350	<b>1</b>		
5		44	145	2056	<b>58</b>		
6		44	142	2056	<b>3</b>		
7		44	78	2056	<b>4</b>		
8		44	74	2056	<b>4</b>		
9		44	142	2056	<b>1</b>		
10		44	145	2056	<b>1</b>		
11		44	145	2056	<b>1</b>		
12		28	145	1388	<b>1</b>		
13		28	145	1388	<b>1</b>		
14		28	145	440	<b>4</b>		
15	 	45	145	245	<b>16</b>		
16	 	45	145	245	<b>8</b>		
17		28	60	1140	<b>16</b>		
18		44	145	150	<b>1</b>		

Nr	Element	Size	pcs	A	B
A		3,0x25	<b>12</b>		
B		3,5x25	<b>296</b>		
C	 	5x80	<b>32</b>		
D		4,5x60	<b>46</b>		
E		5x100	<b>60</b>		
F		3x100x240	<b>24</b>		
G			<b>2</b>		
H		40x40	<b>2</b>		

# Outils

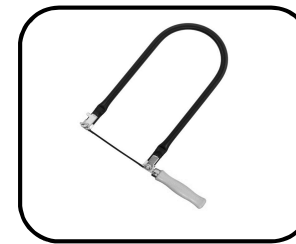
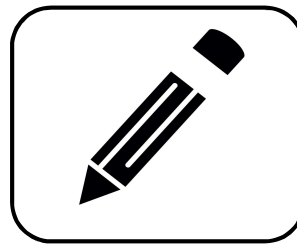
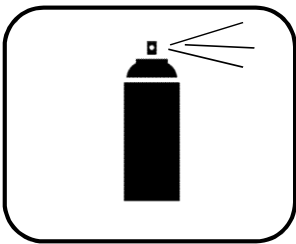
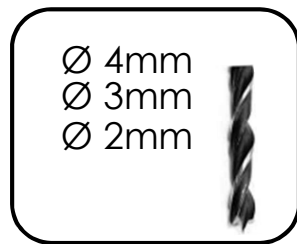
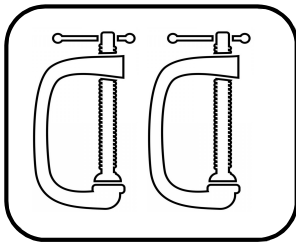
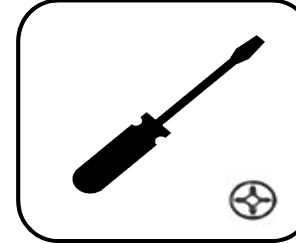
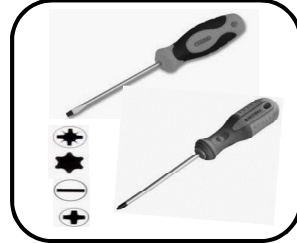
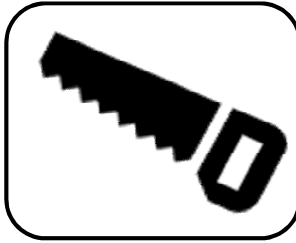
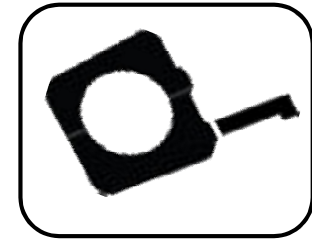
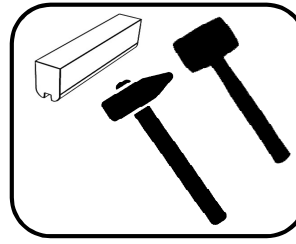
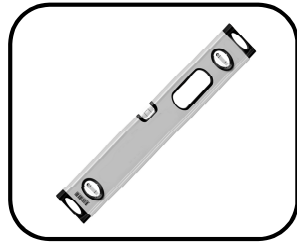
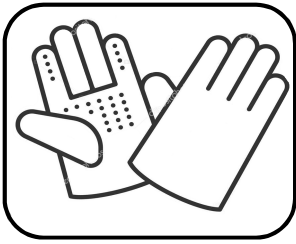

# Important

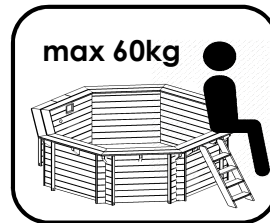
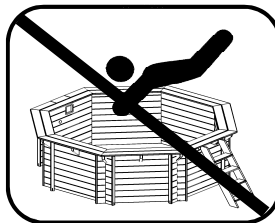
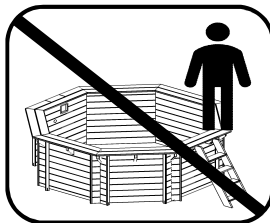
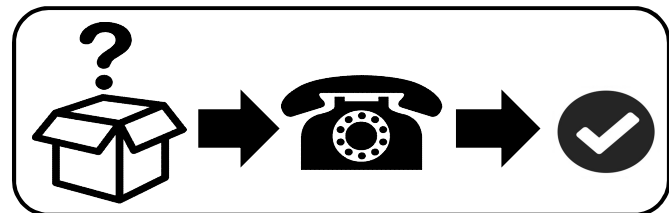
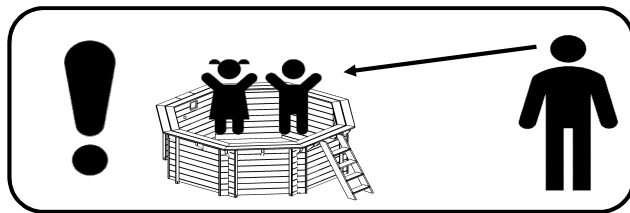
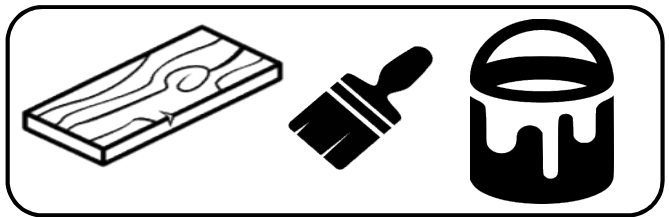
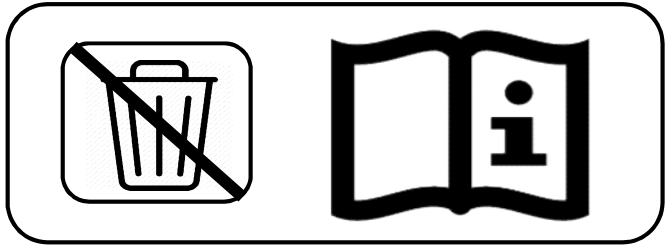
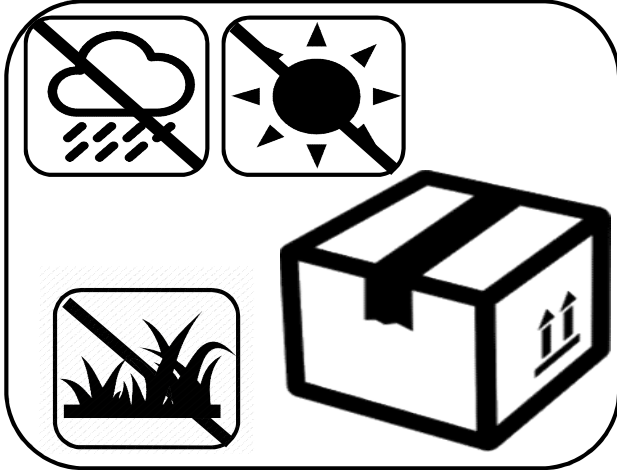
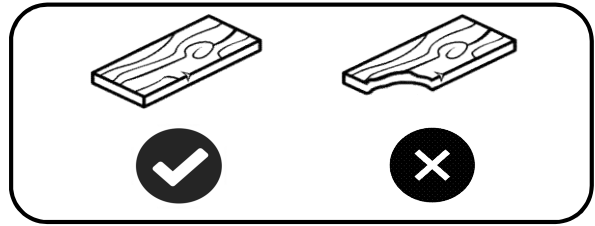
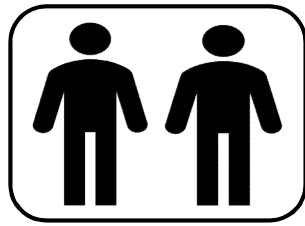

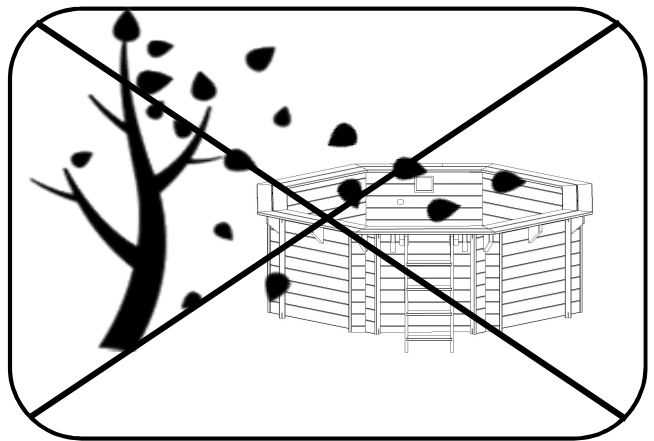
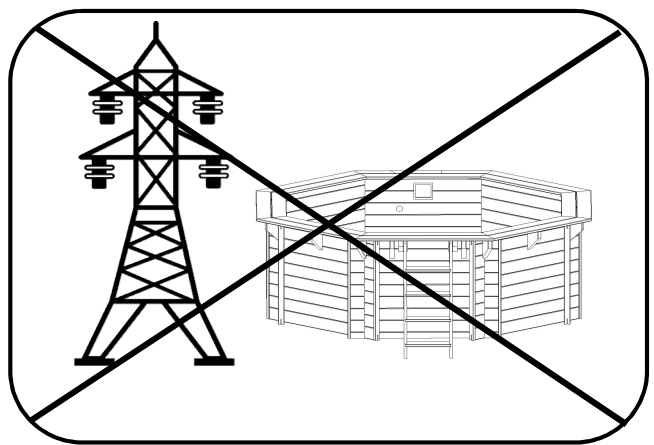
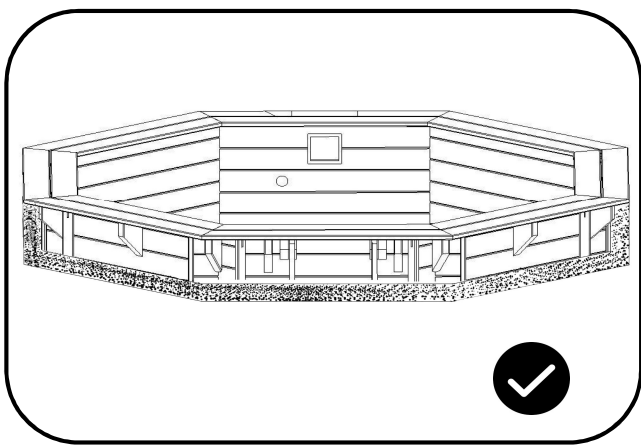
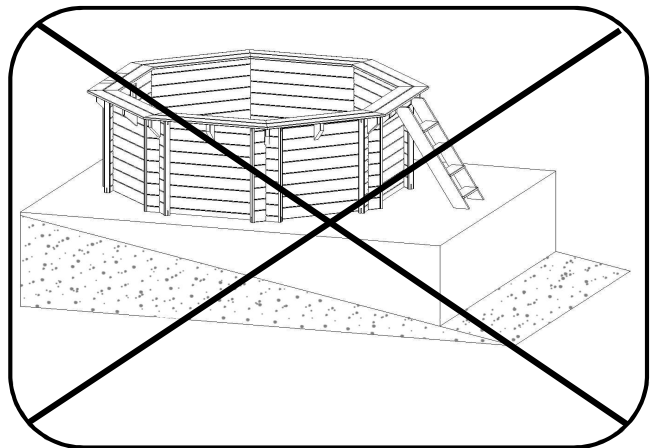
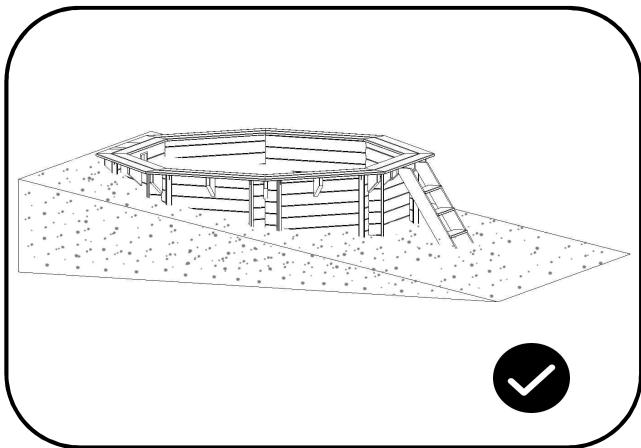
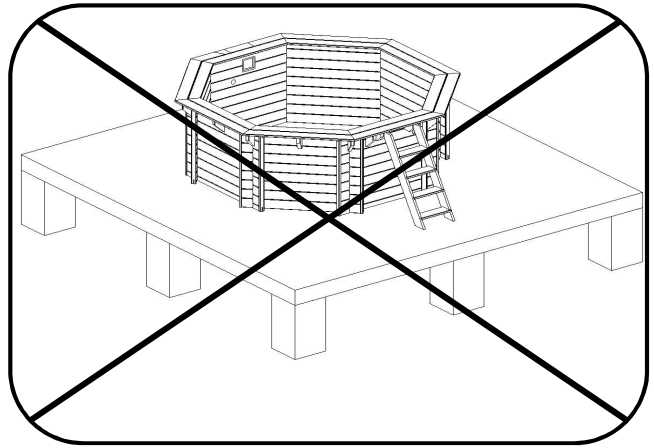
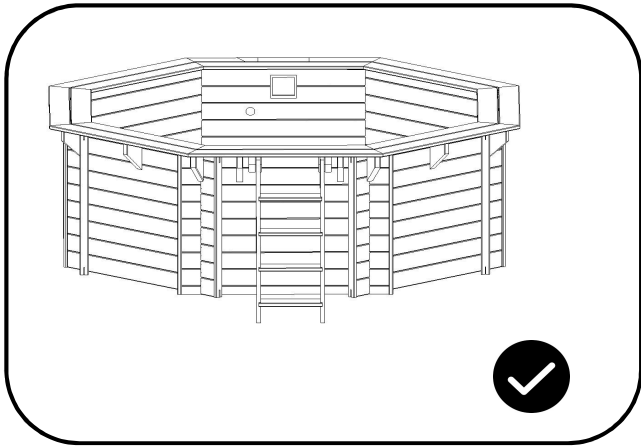

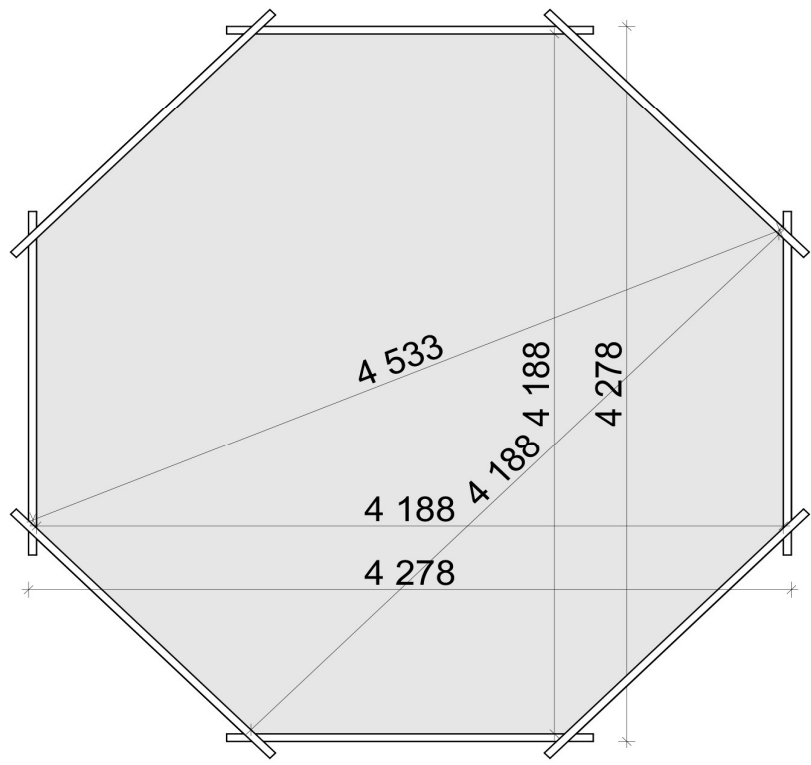
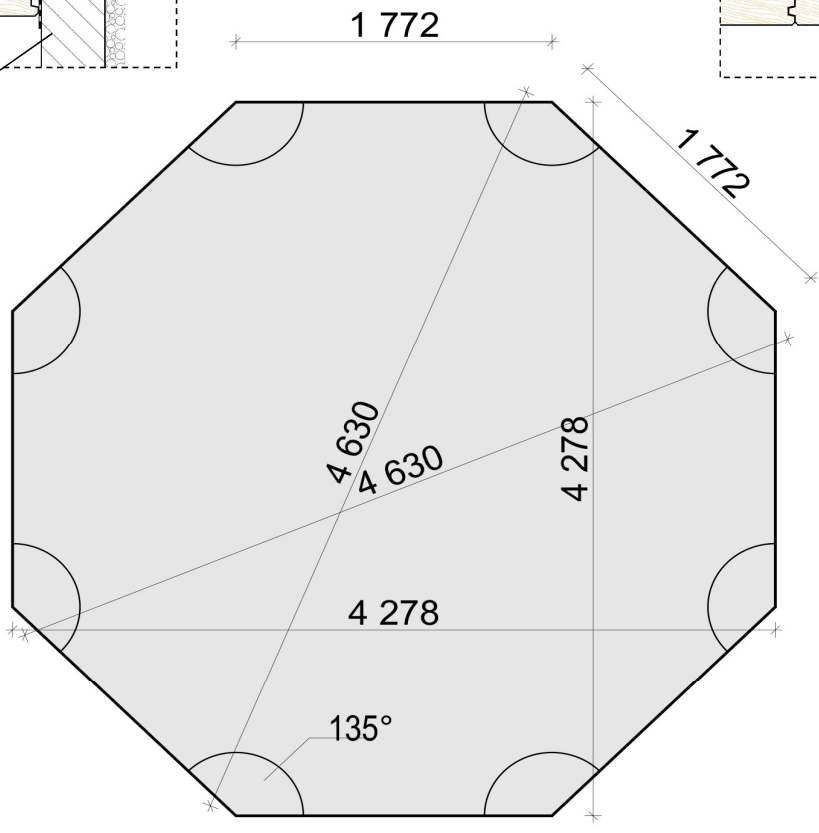
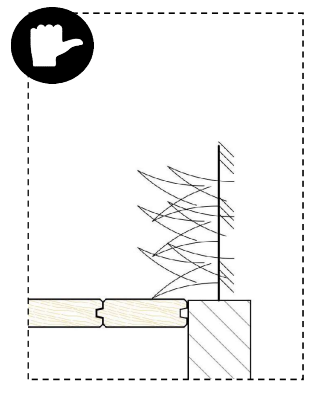
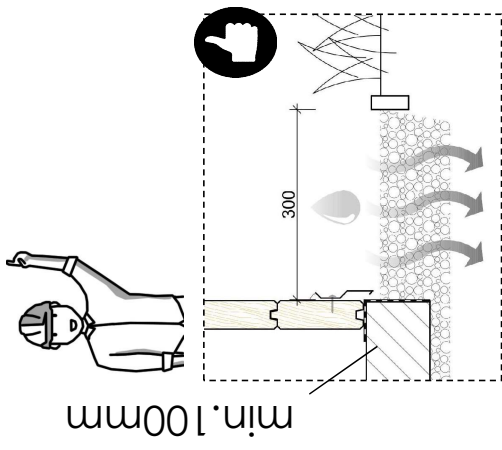

1

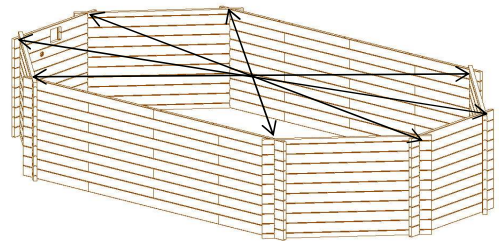
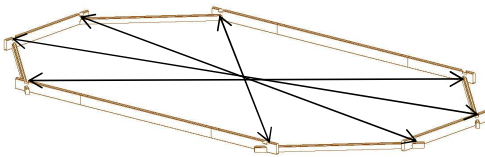
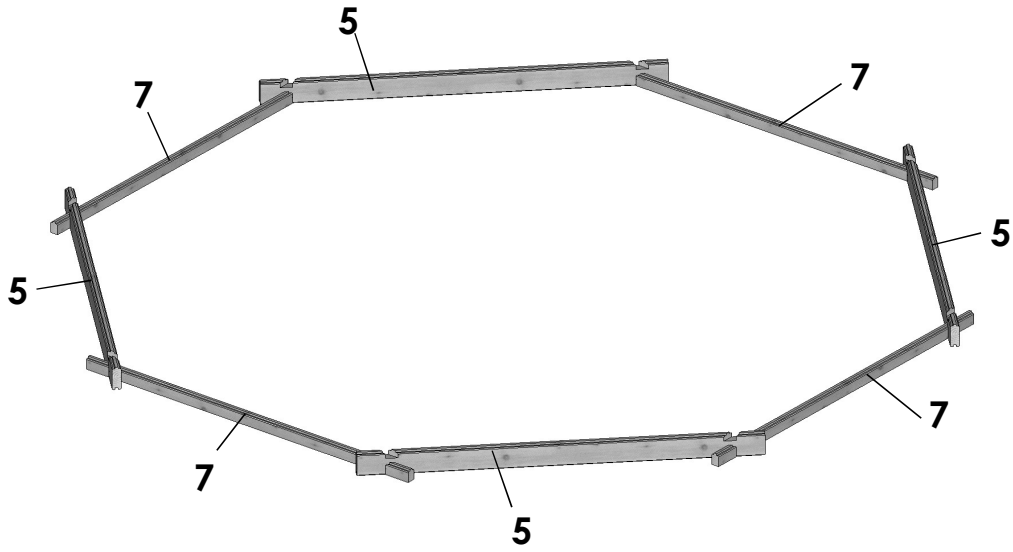
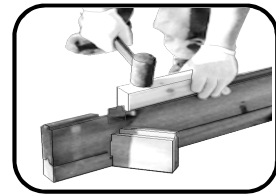
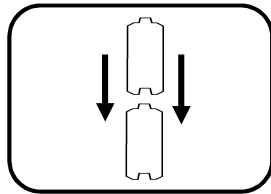
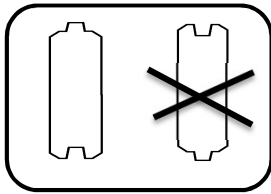

2

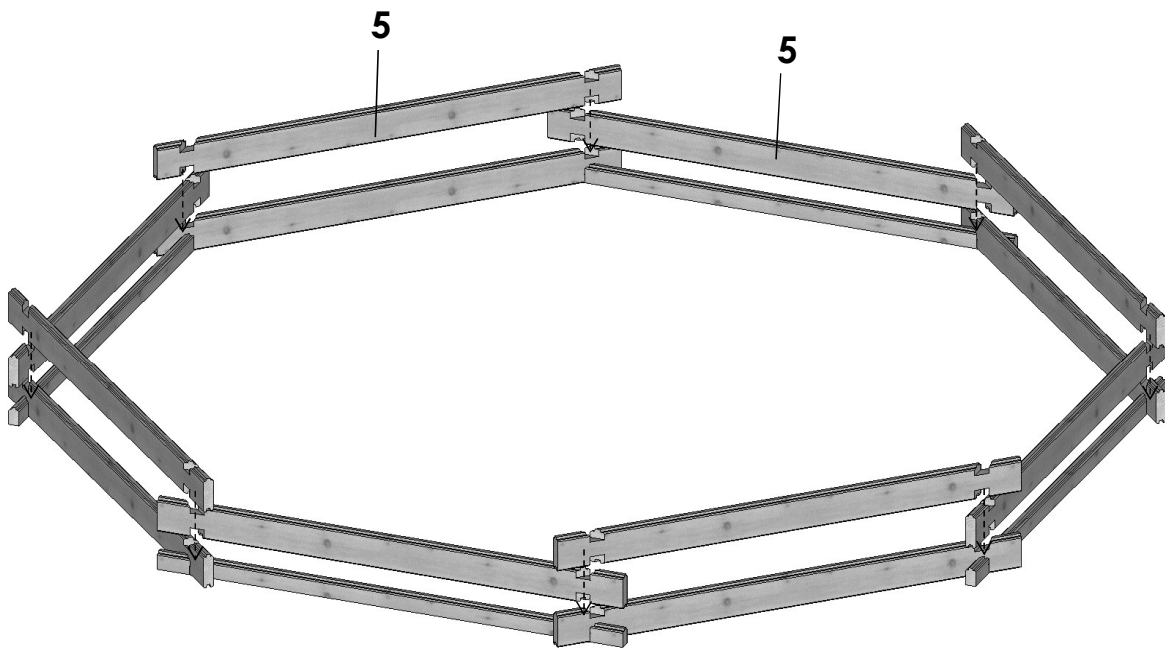



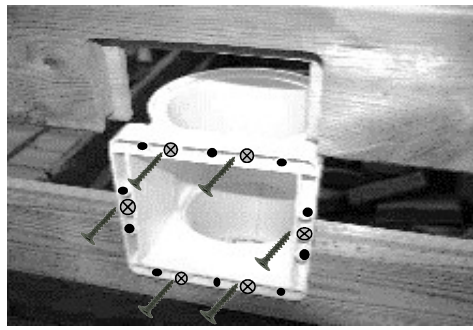
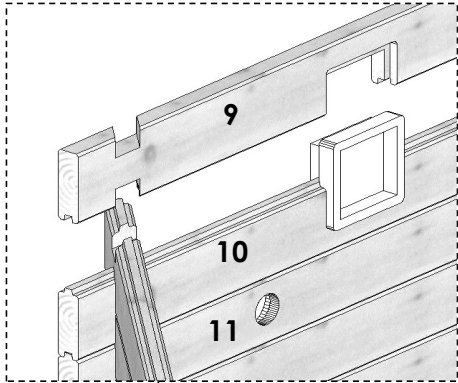

Ø4,0x40 (x6)



+ Ø4,0x40 (x16)

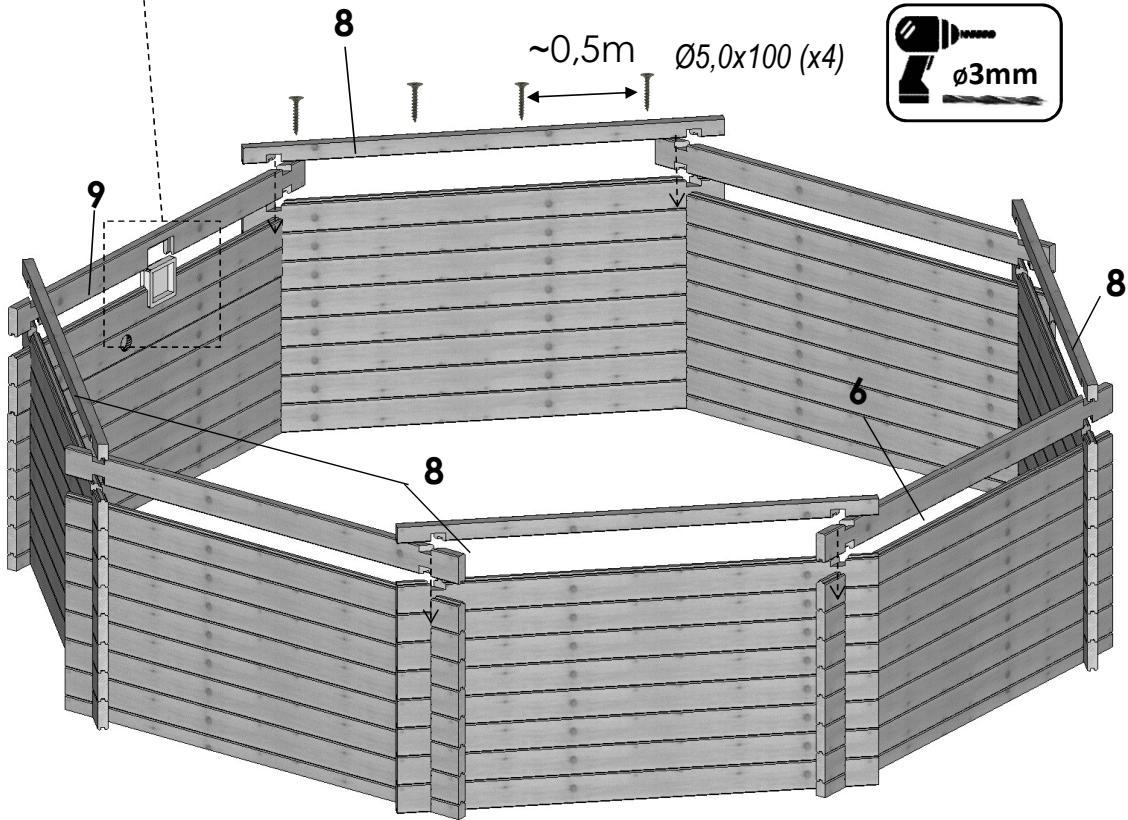

4

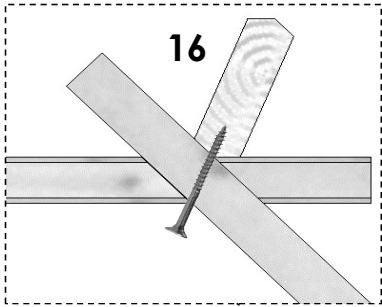

Ø5,0x100 (x2)

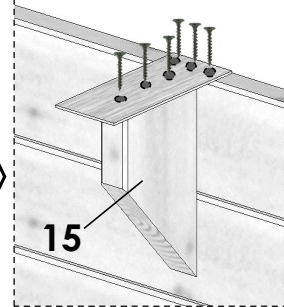
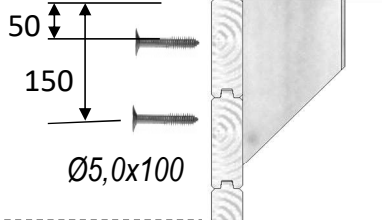
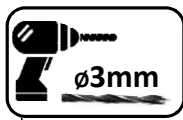

Ø3,5x25 (x6)

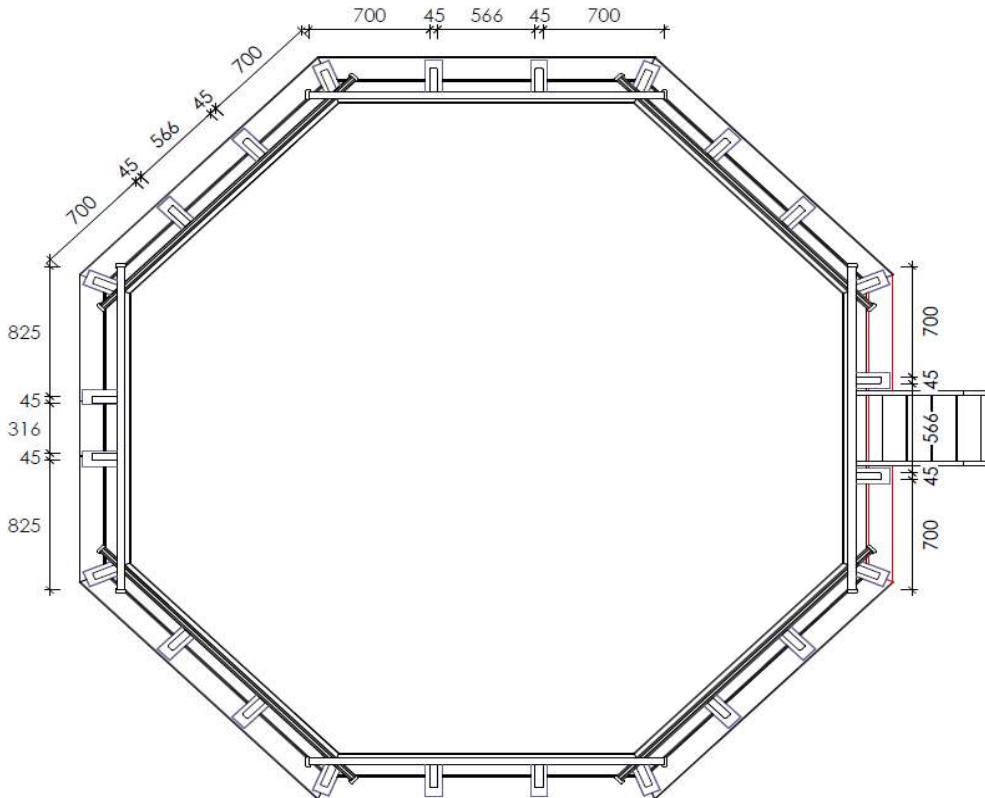
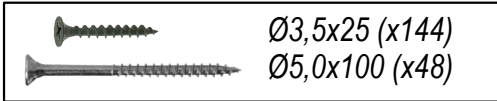
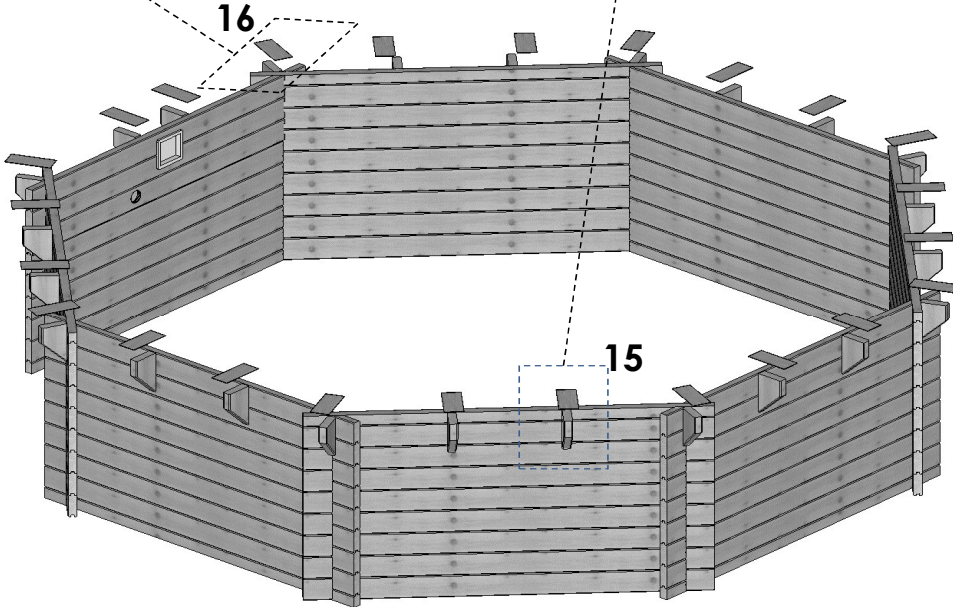

5

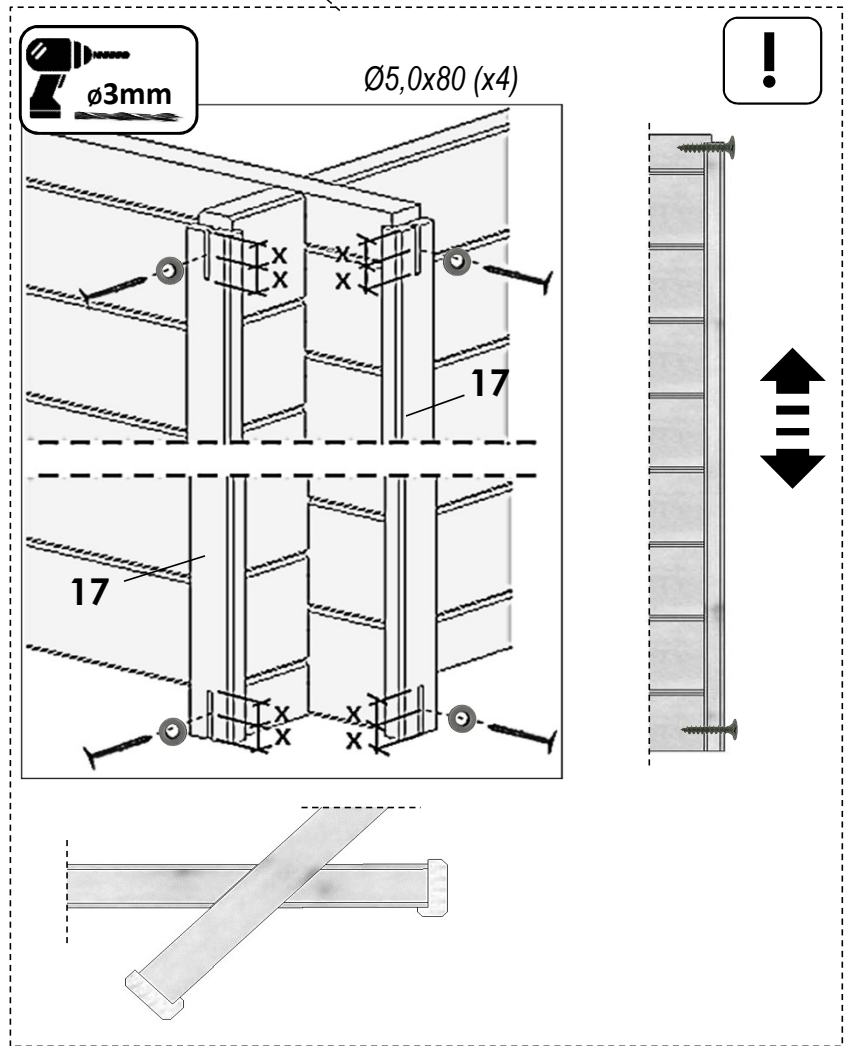
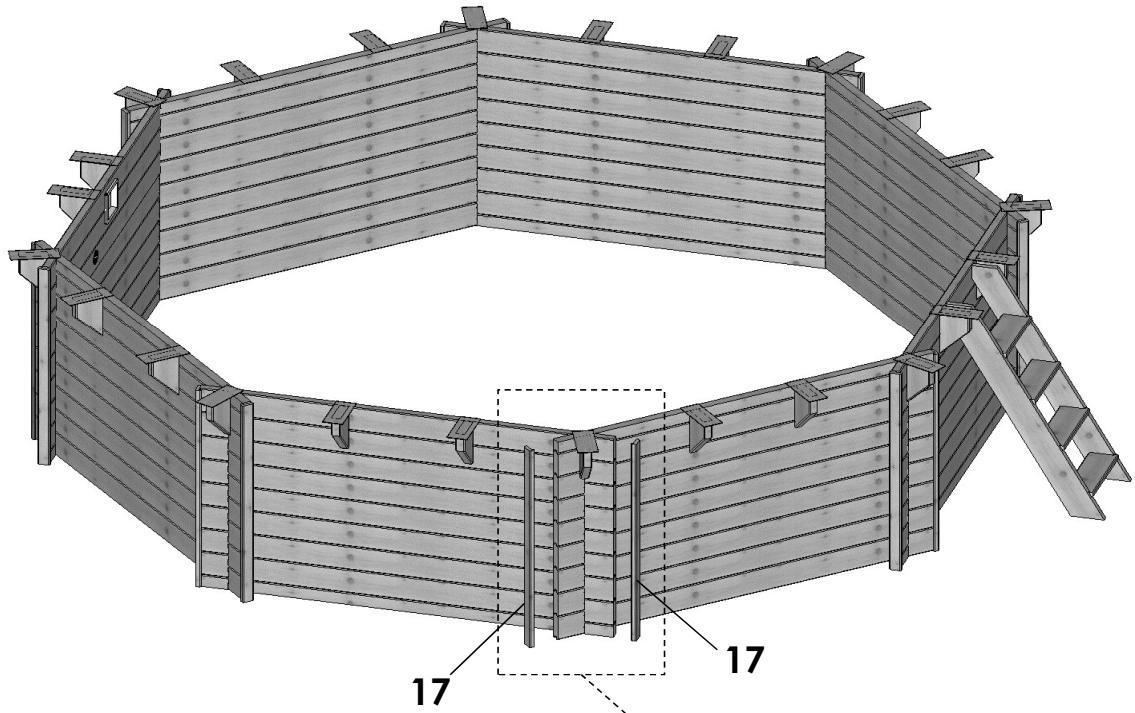

Ø5,0x80 (x32)

6

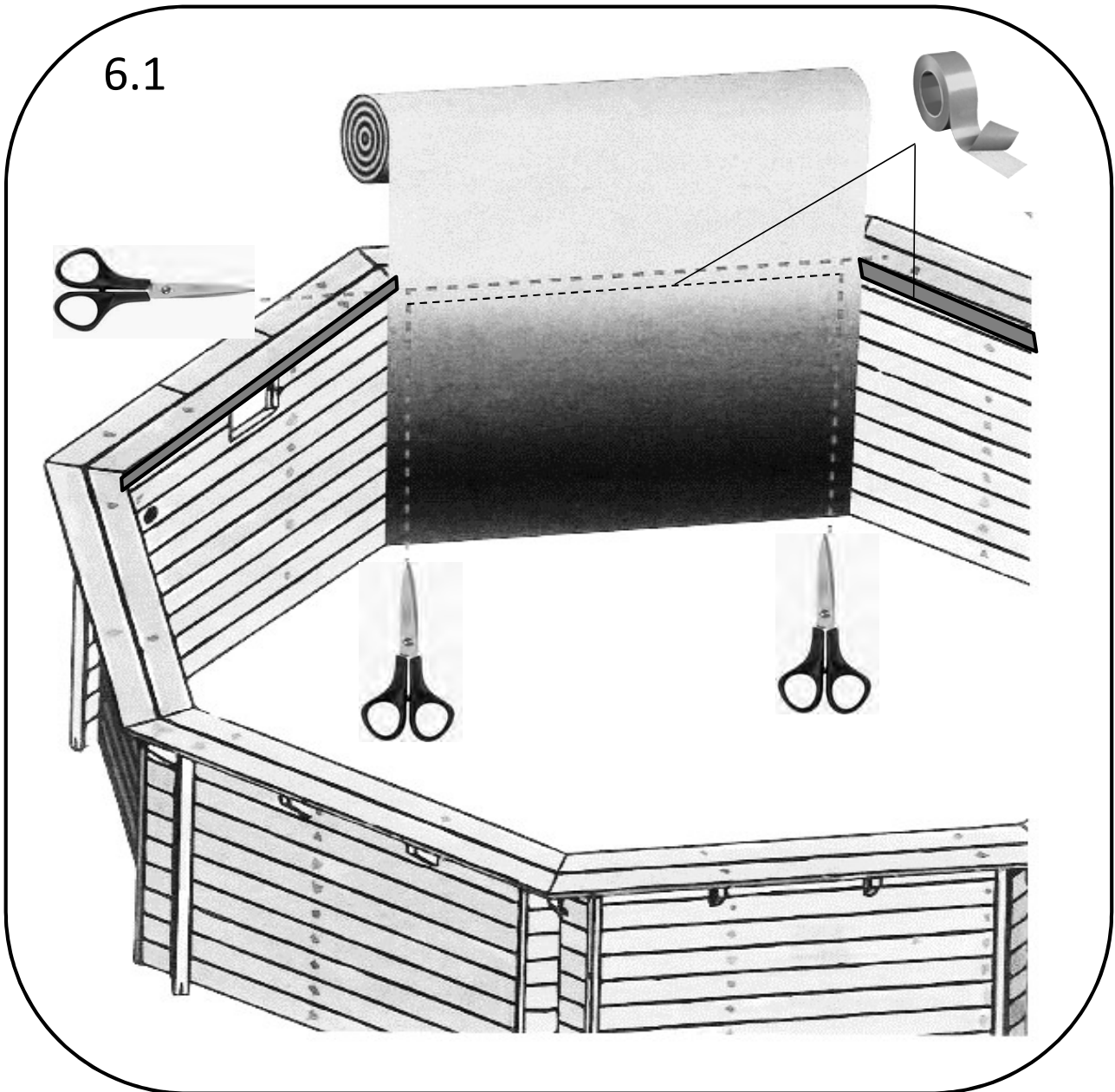

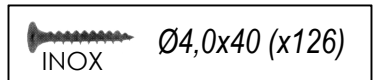
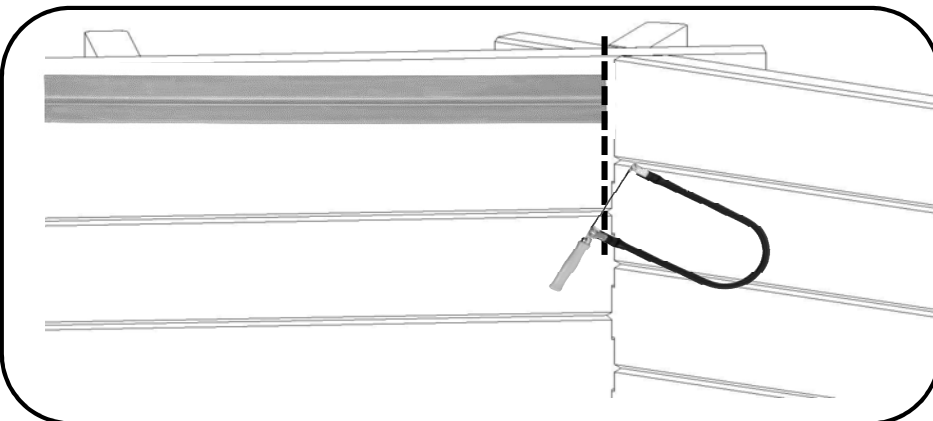
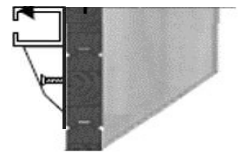
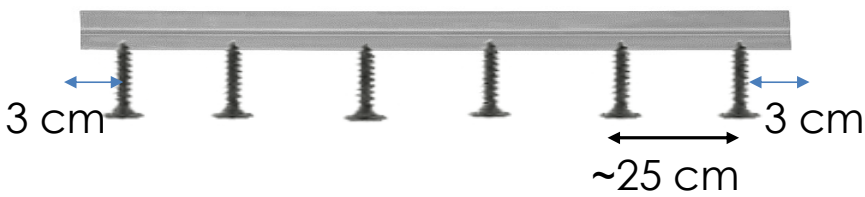
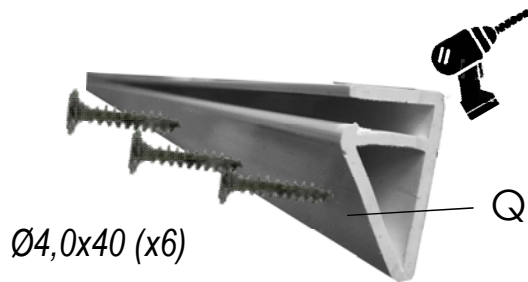
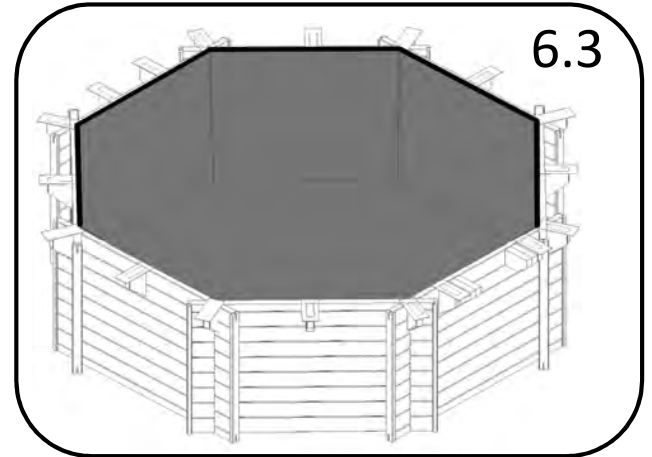
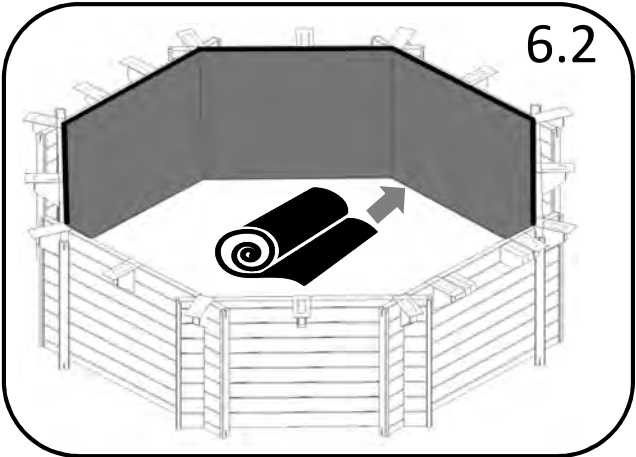
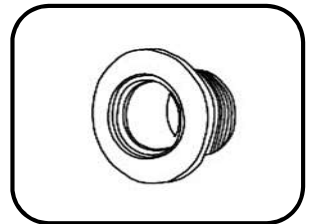
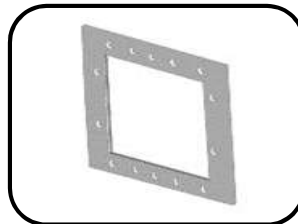
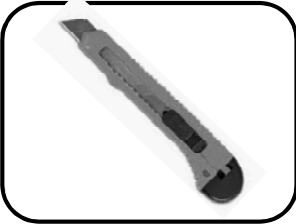
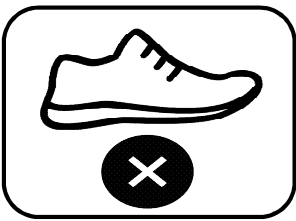

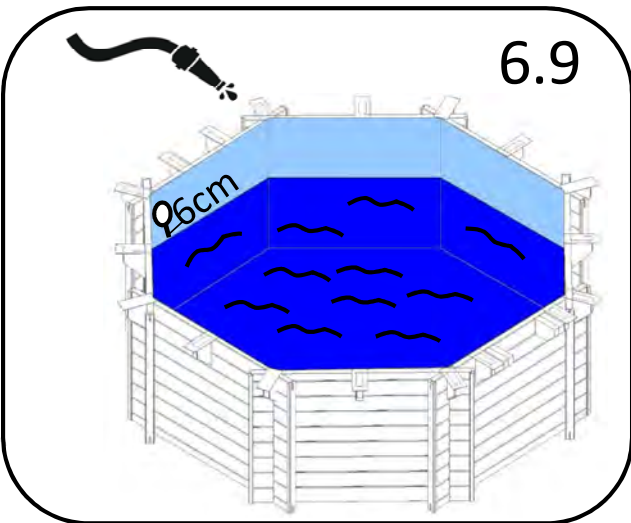
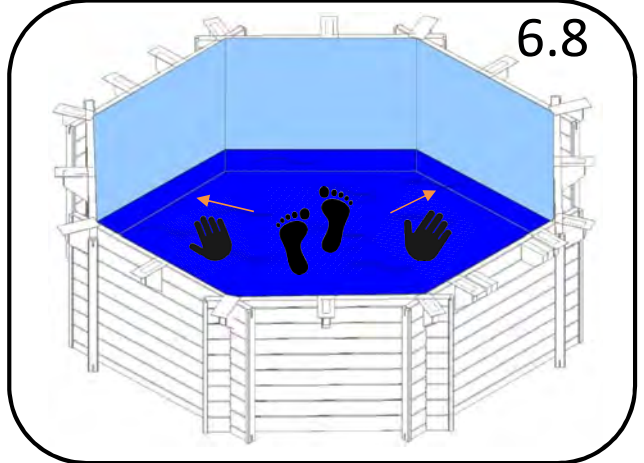
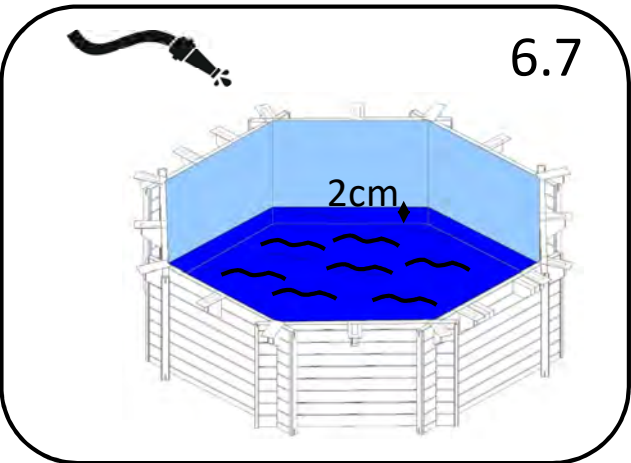
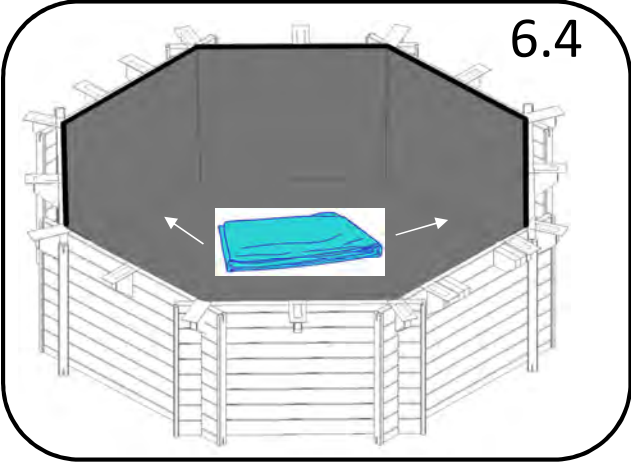
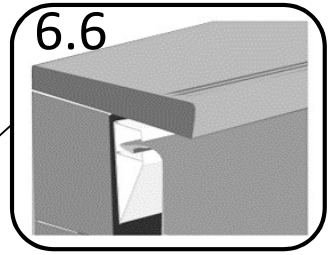
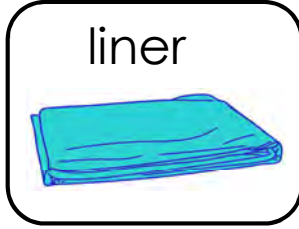
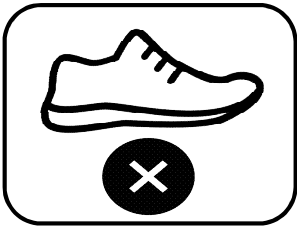

6.10

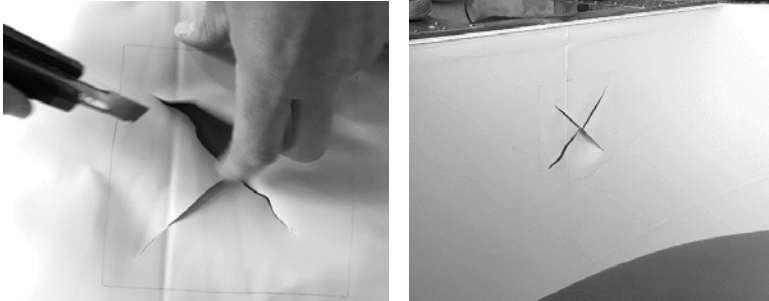
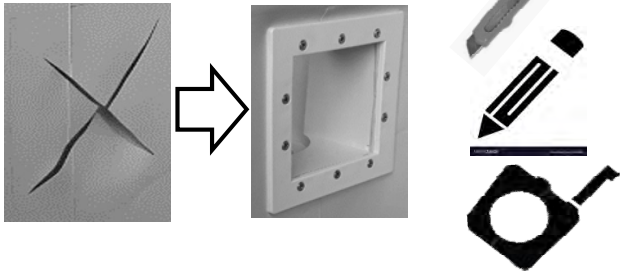

6.11



Ø4,0x40 (x10)



inside the pool

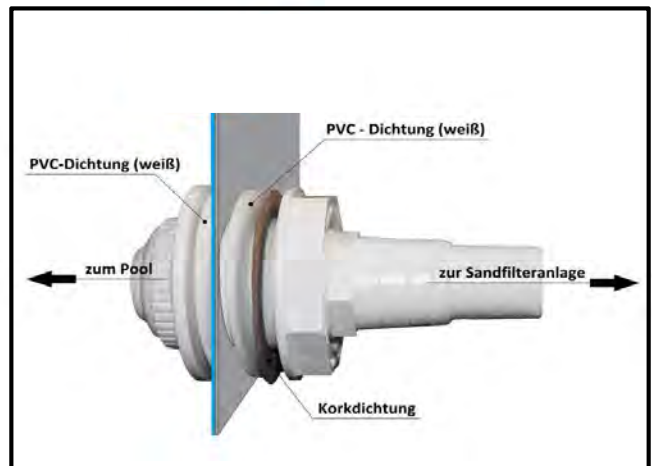
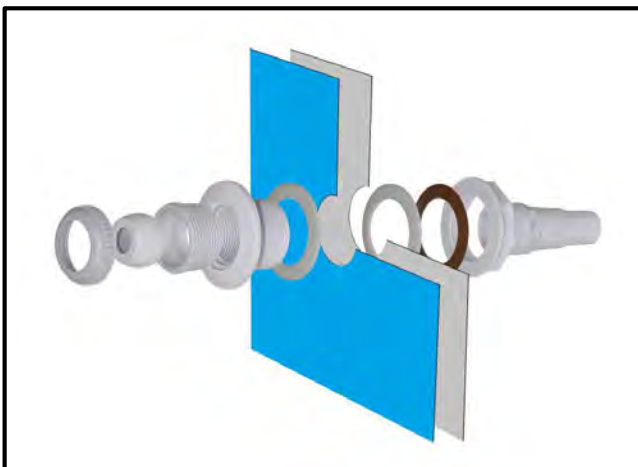
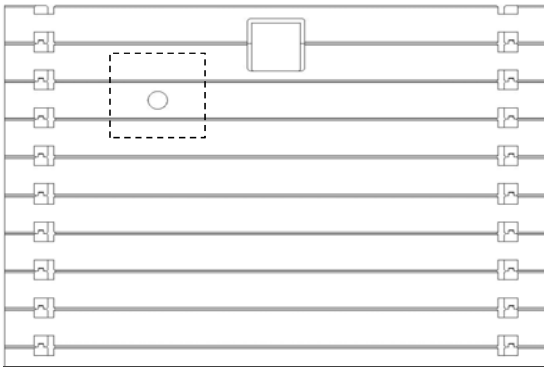



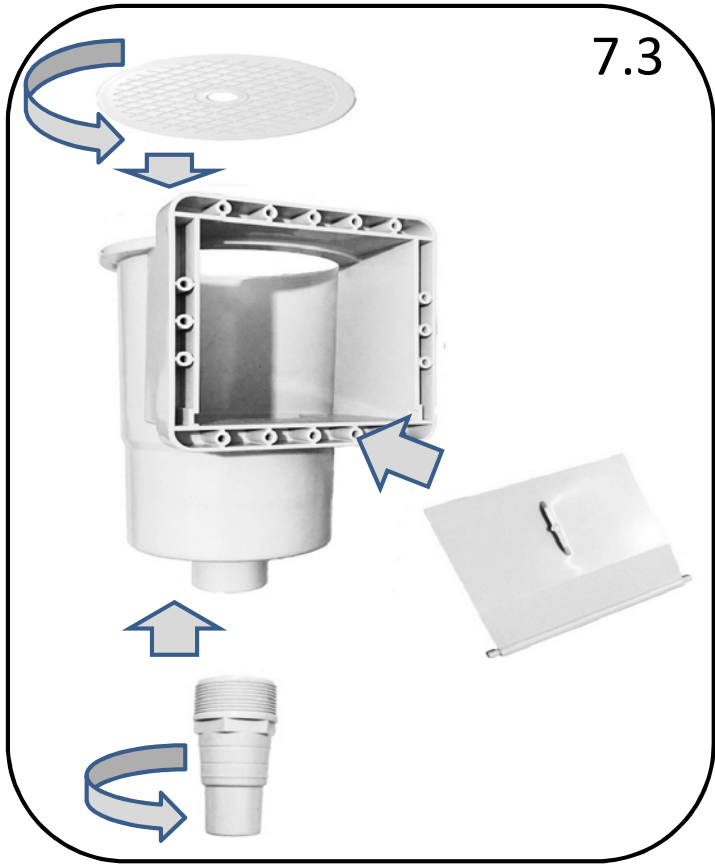
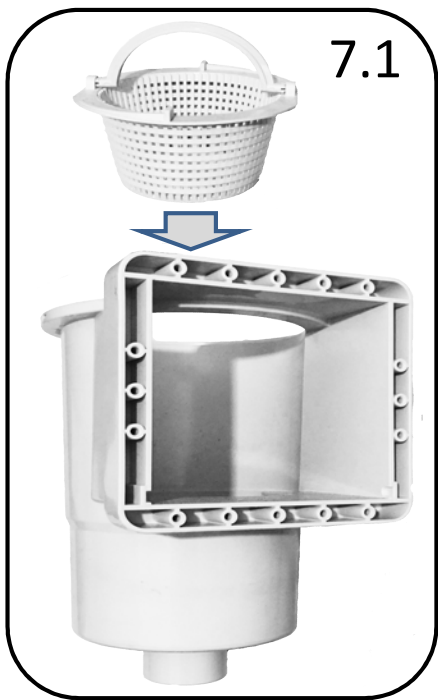

7



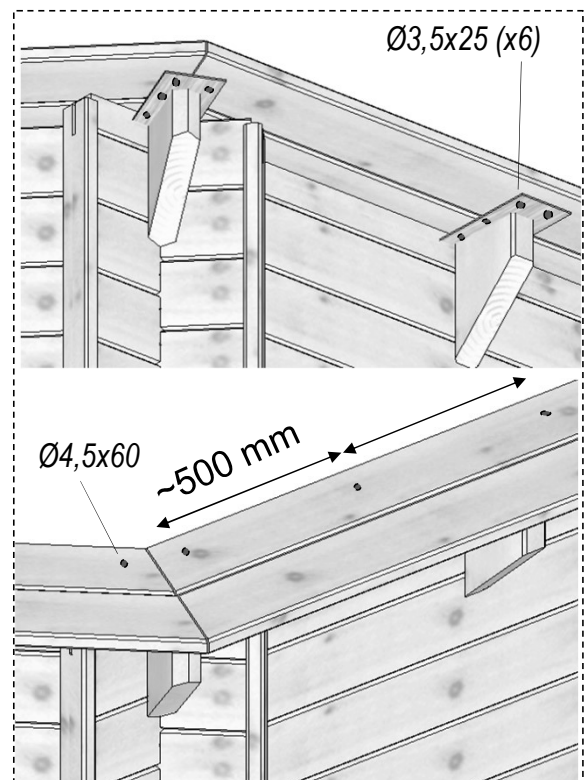
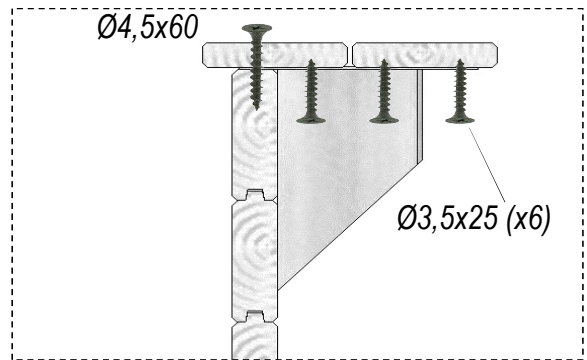
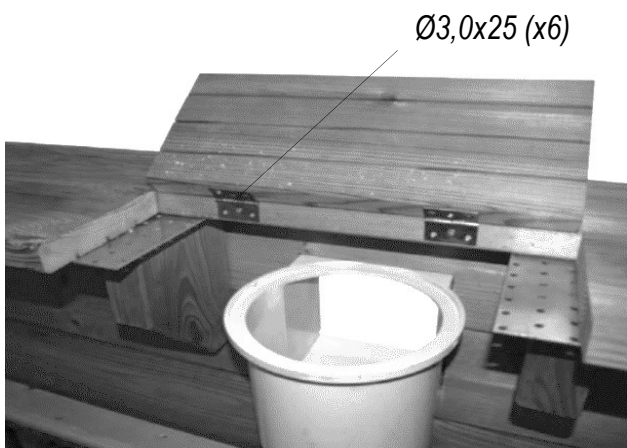
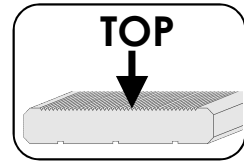
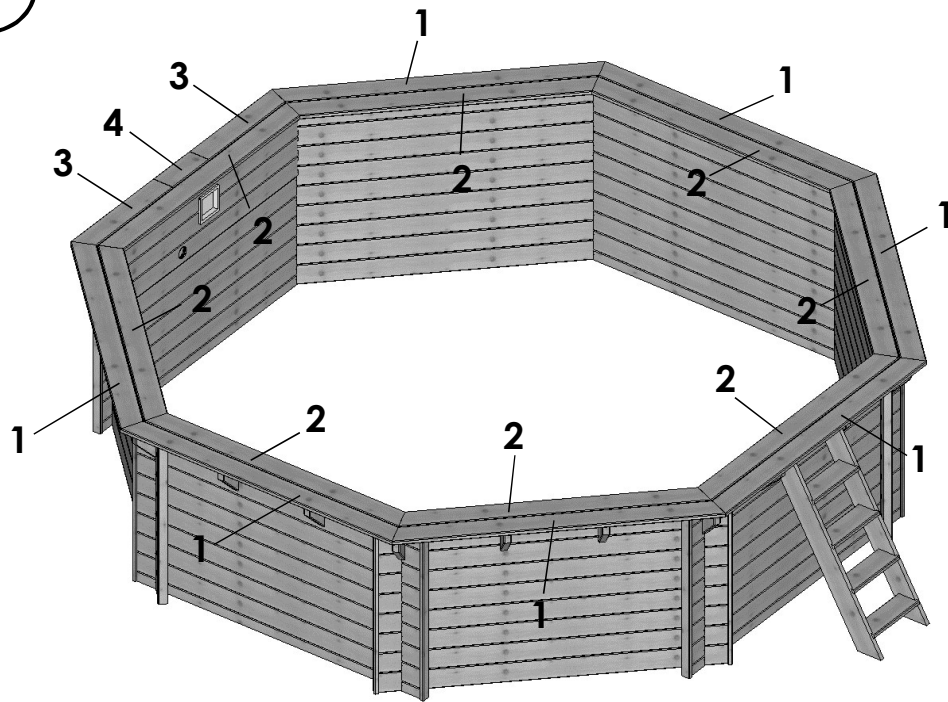

6





- |   |                |
|---|----------------|
|  | Ø3,0x25 (x12)  |
|  | Ø3,5x25 (x144) |
|  | Ø4,5x60 (x32)  |

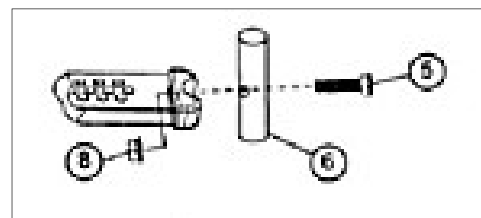
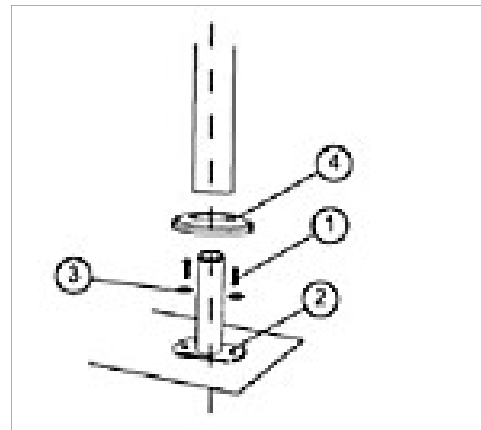
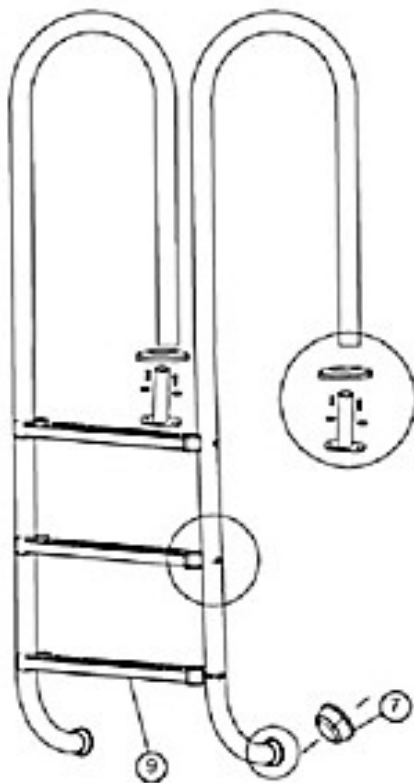

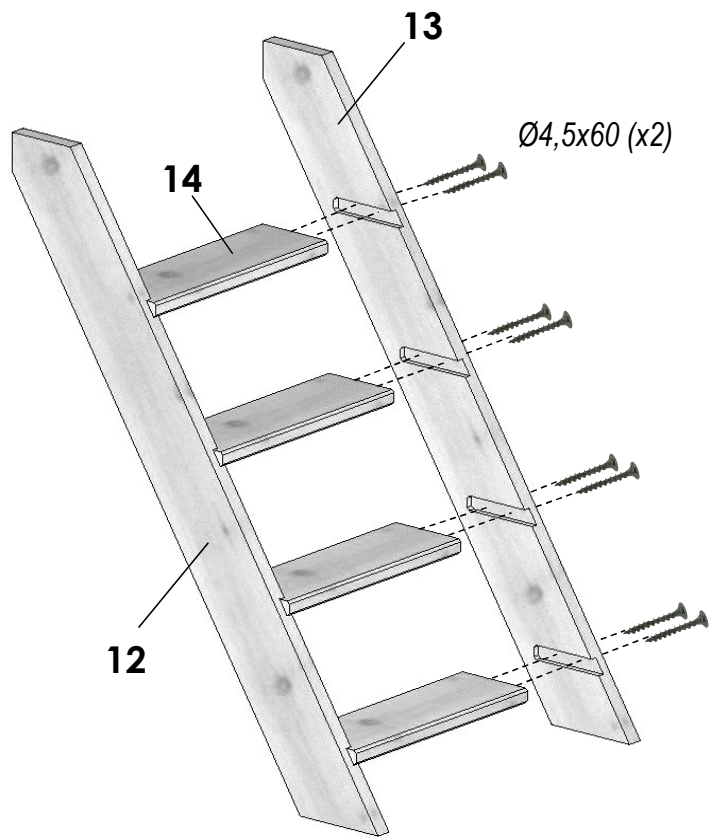
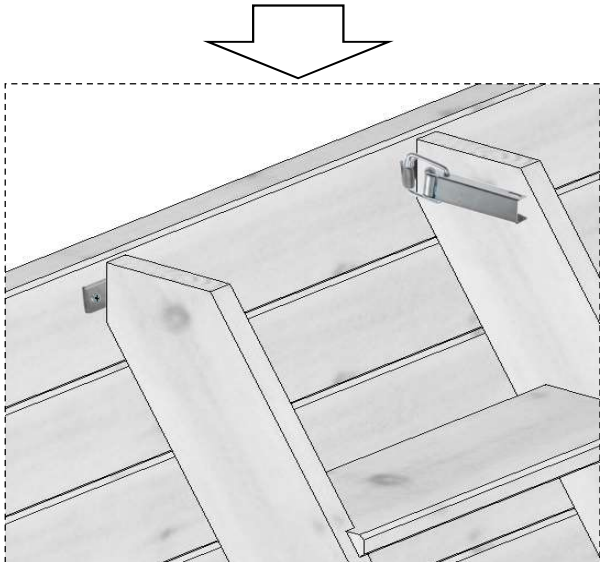
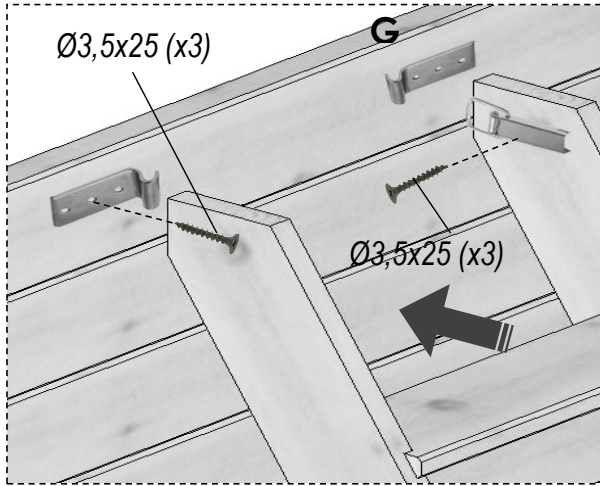

1	Skrews A	x4
2	Clamping foot	x2
3	Washers	x4
4	Overlays	x2
5	Skrews B	x6
6	Brackets	x2
7	Articulated bumpers	x2
8	Nuts	x6
9	Steps	x3



	Ø3,5x25 - x12
	Ø4,5x60 - x16

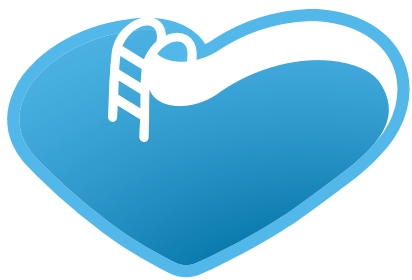

# BSVillage

[.com](http://www.bsvillage.com)

PISCINE - WELLNESS - OUTDOOR

[www.bsvillage.com](http://www.bsvillage.com)

BUSINESS SHOP S.r.l. a Socio Unico  
Via della Repubblica n. 19/1 - 42123 Reggio Emilia (RE)  
P.Iva e C.F. 02458850357 - Cap. soc. 60.000,00 € i.v.

 [www.bsvillage.com](http://www.bsvillage.com)

 0522 15 36 417

 [info@bsvillage.com](mailto:info@bsvillage.com)

 0522 18 40 494