

PL Instrukcja montażu

GB Assembly instructions

D Montageanleitung

FR Notice de montage

IT Istruzioni di montaggio

RU Инструкция по монтажу

Nazwa /Name /Name /Nom /Nome /Имя

ECOWOOD EASY PLUS 730



**BSVILLAGE
PISCINE**

www.bsvillage.com

UWAGA /REMARQUE /N /NOTE /ATTENZIONE /HINWEIS /ВНИМАНИЕ

PL Objętość wody w basenie 25,45 m³

FR Le volume de l'eau dans la piscine 25,45 m³

GB Water capacity in the pool 25,45 m³

IT Il volume di acqua in piscina 25,45 m³

D Volumen von Wasser im Schwimmbecken 25,45 m³

RU Объем воды в бассейне 25,45 м³

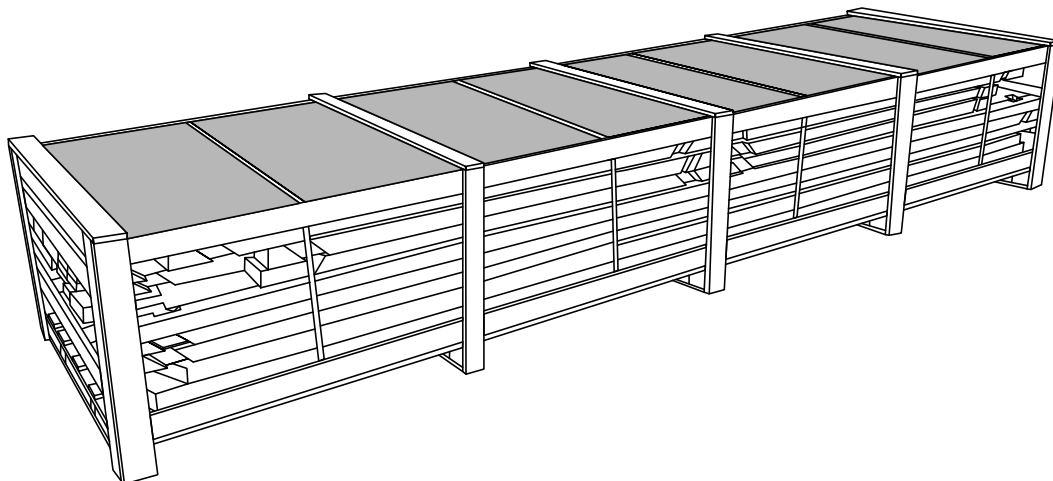
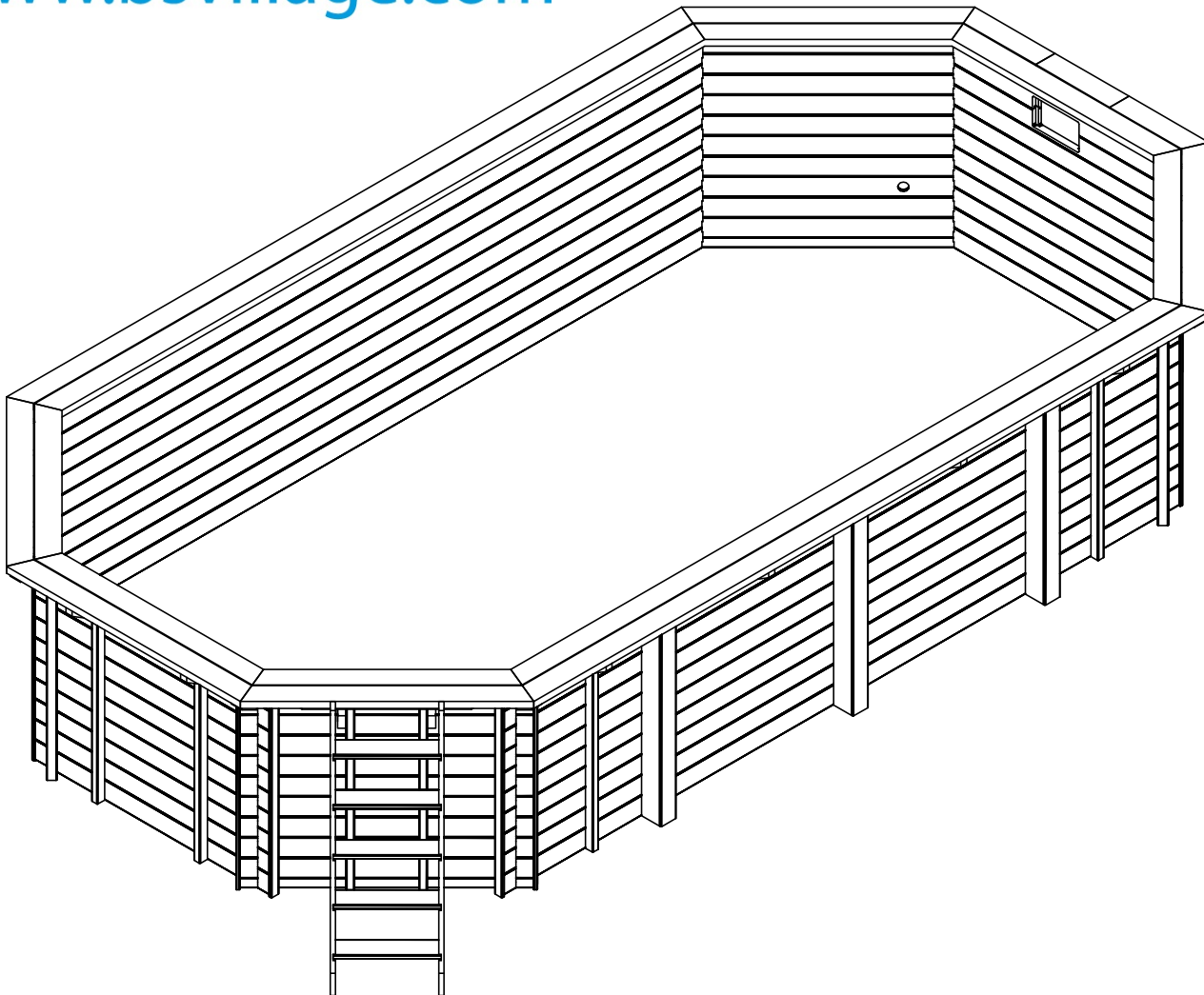

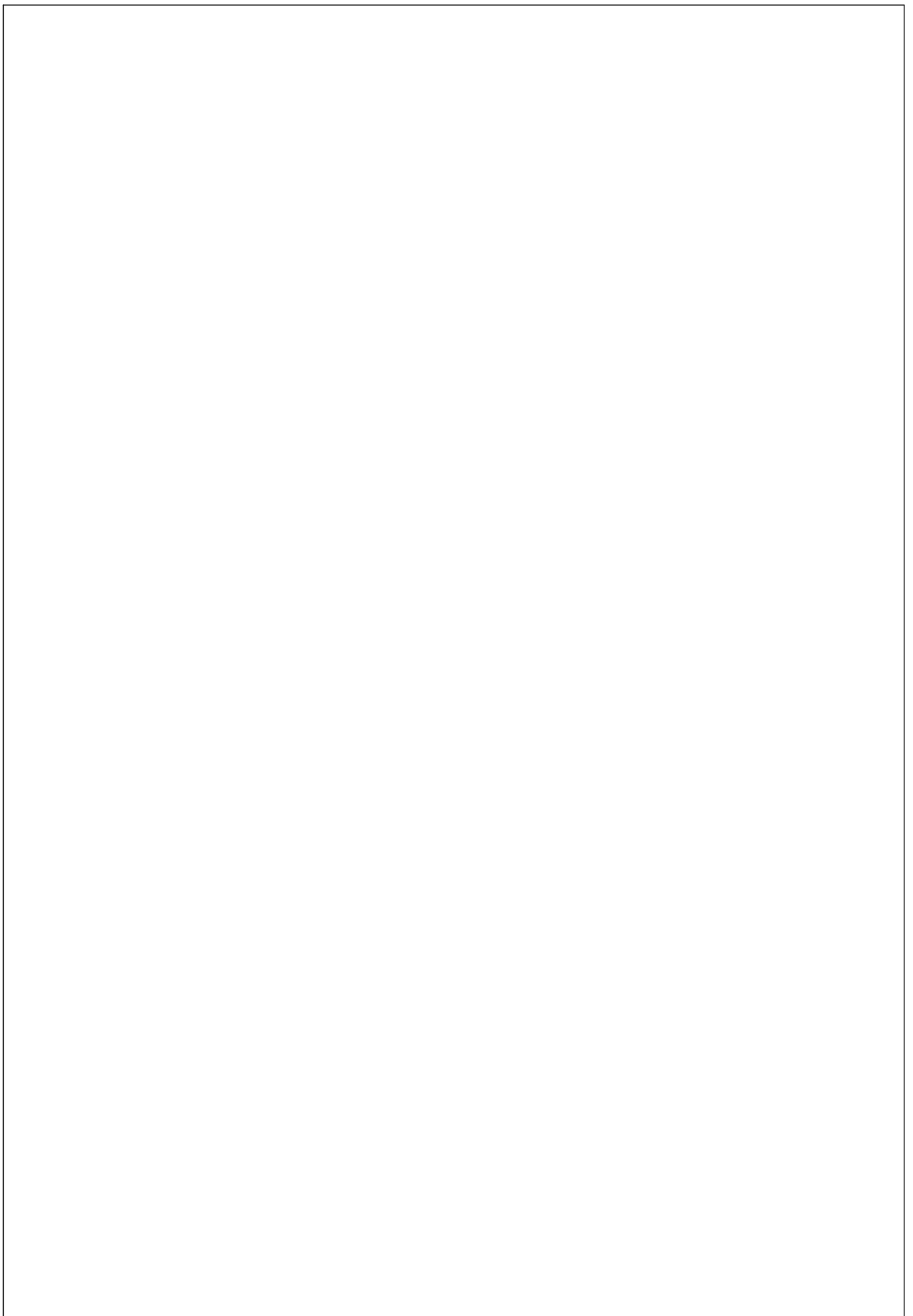

(PL) Instrukcja montażu

(GB) Assembly instructions

(D) Montageanleitung

(FR) Notice de montage

(IT) Istruzioni di montaggio

(RU) Инструкция по монтажу



(PL) Przed przystąpieniem do montażu zapoznaj się z instrukcją. * Bez wylewki betonowej.

(FR) Avant le montage lisez attentivement la notice. * Sans la dalle en béton.

(GB) Read carefully pool installation manual before the installation. * Without concrete base.

(IT) Prima del montaggio è necessario consultare il manuale. * Senza una lastra di cemento.

(D) Vor der Montage machen Sie sich bitte mit der Bedienungsanleitung bekannt. * Ohne Betonestrich.

(RU) Перед монтажом ознакомьтесь с инструкцией. * Без бетонного основания.

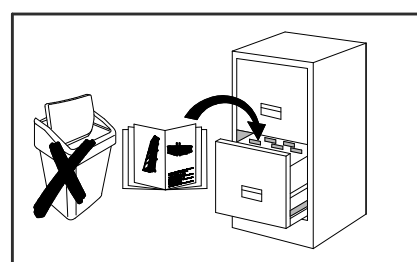
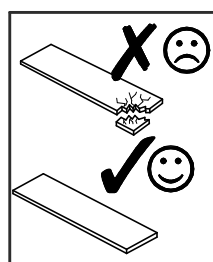
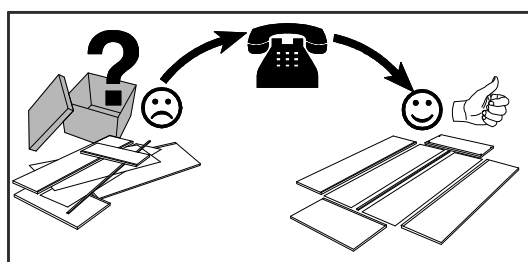
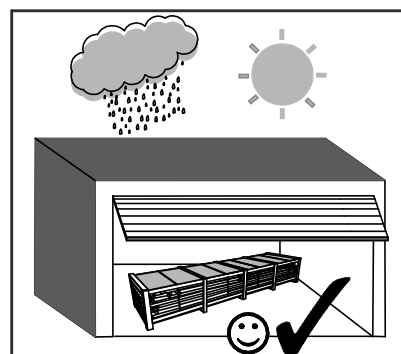
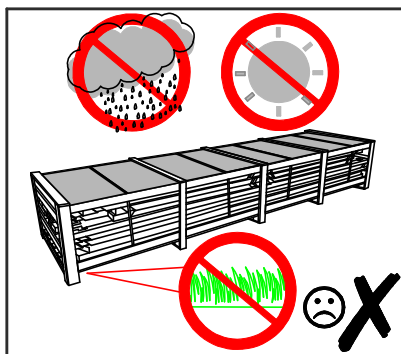
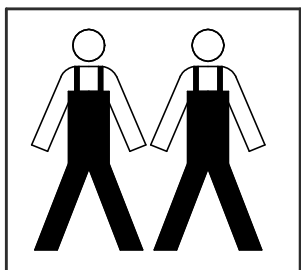
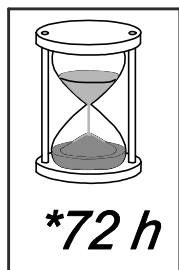

UWAGA /ATTENTION /NOTE/ ATATTENZIONE /HINWEIS /ВНИМАНИЕ

(PL) Montaż wykonać w przeciągu 3 dni od rozpakowania struktury.

(FR) Il faut monter la structure au cours de 3 jours de l'ouverture du colis.

(GB) Installation should be finished within 3 days from opening the package.

(IT) Il montaggio effettuare entro 3 giorni dal disimballo della struttura.

(D) Die Montage ist innerhalb von 3 Tagen zu machen, nachdem die Konstruktion geöffnet wird.

(RU) Монтаж выполнять в течение 3 дней от распаковки структуры.

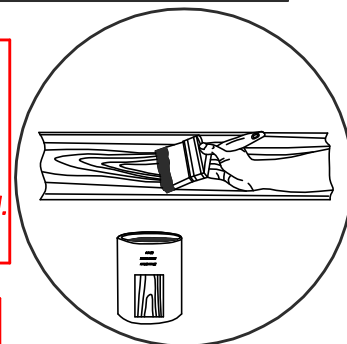

UWAGA /ATTENTION /NOTE/ ATATTENZIONE /HINWEIS /ВНИМАНИЕ

(PL) Brak corocznej konserwacji struktury powoduje utratę gwarancji.

(FR) Le manque de conseravtion annuelle de la structure cause la perte de la garantie.

(GB) Lack of once a year conservation of the structure causes loss of warranty.

(IT) Mancanza della manutenzione annuale causa la perdita di garanzia.

(D) Keine jährliche Wartung der Konstruktion macht das, das die Garantie verloren geht.

(RU) Отсутствие ежегодного ухода за структурой влечет за собой потерю гарантии.



UWAGA /ATTENTION /NOTE/ ATATTENZIONE /HINWEIS /ВНИМАНИЕ

(PL) Nie pozostawiać dzieci bez nadzoru!

(FR) Ne laissez pas les enfants sans surveillance!

(GB) Do not leave children unattended!

(IT) Non lasciare bambini incustoditi!

(D) Lassen Sie Kinder nicht unbeaufsichtigt!

(RU) Не оставлять детей без присмотра!

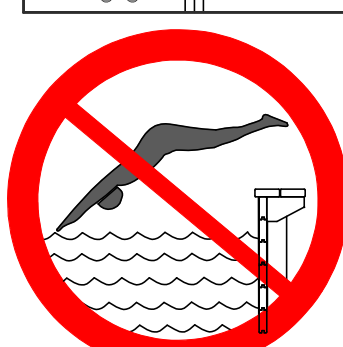
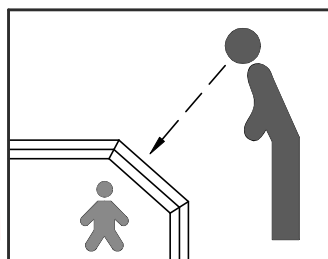

PL Elementy

GB Elements

D Elemente

FR Les éléments

IT Elementi

RU Элементы



- PL** Sprawdź ilość oraz czy elementy nie są uszkodzone.
- FR** Vérifiez la quantité et si les éléments ne sont pas abîmés.
- GB** Check quantity of elements and if they are not faulty.
- IT** Controllare la quantità e se gli elementi non sono danneggiati.
- D** Sie die Menge, und ob die Elemente nicht beschädigt sind.
- RU** Проверить количество, а также не повреждены ли детали.

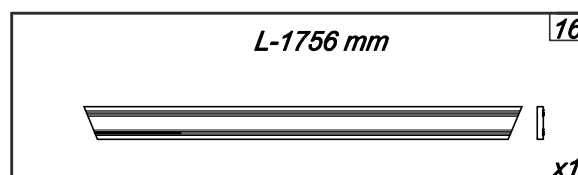
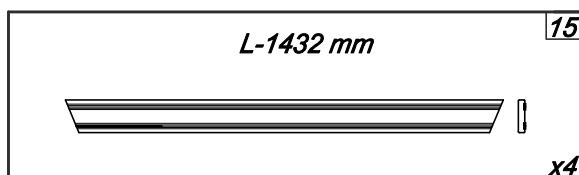
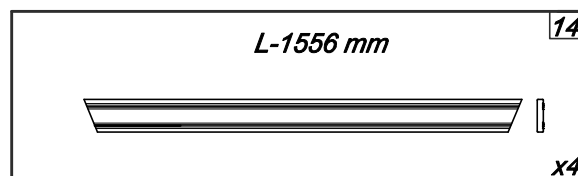
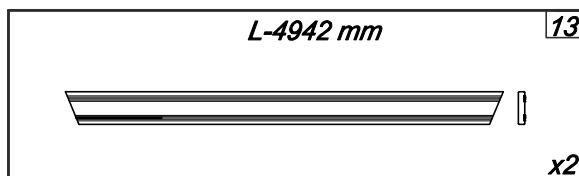
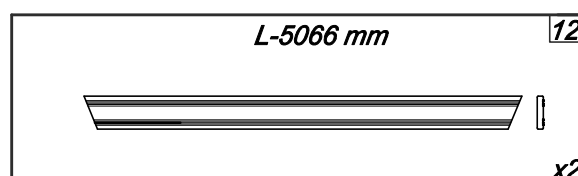
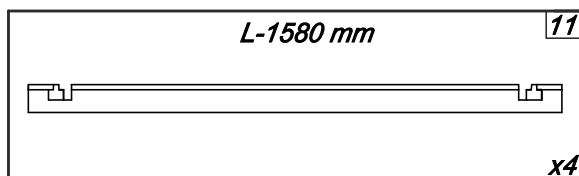
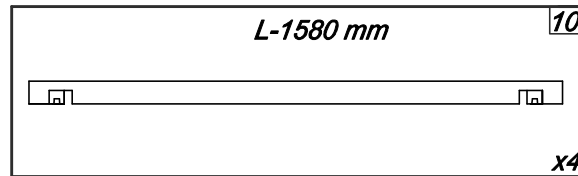
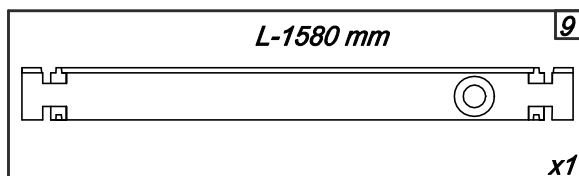
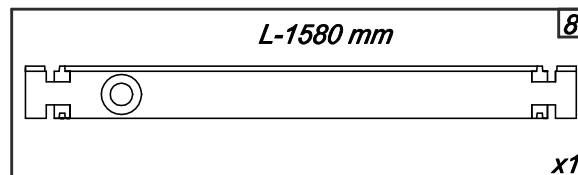
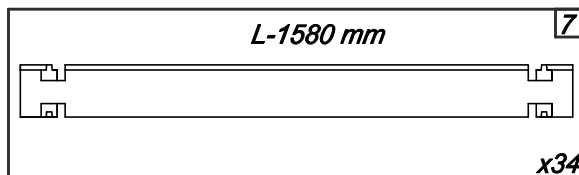
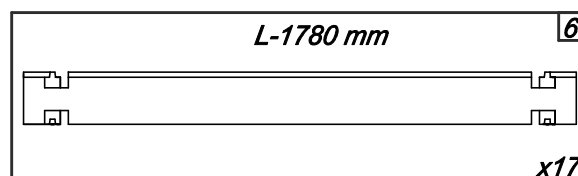
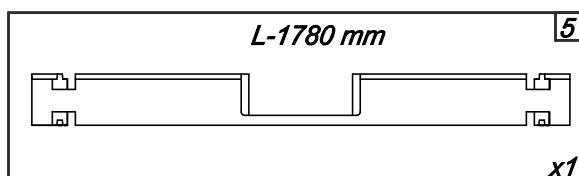
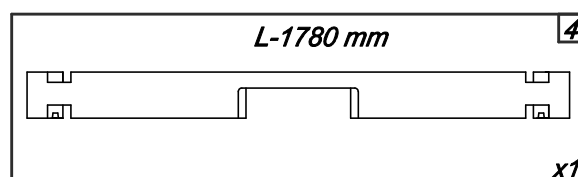
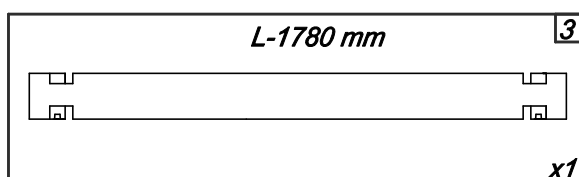
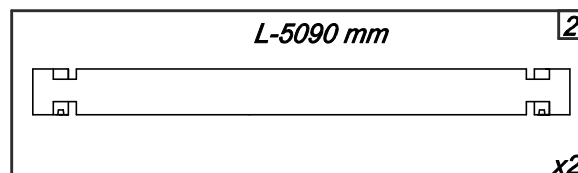
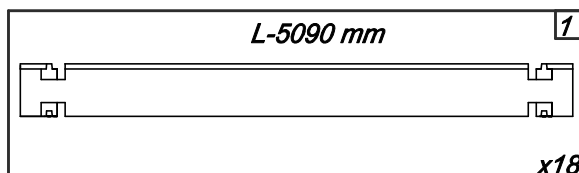
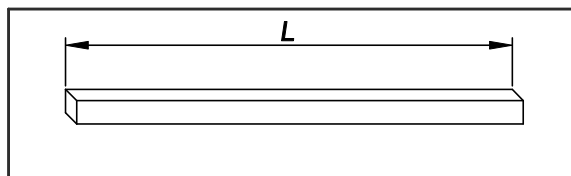

PL Elementy

GB Elements

D Elemente

FR Les éléments

IT Elementi

RU Элементы



- PL** Sprawdź ilość oraz czy elementy nie są uszkodzone.
- FR** Vérifiez la quantité et si les éléments ne sont pas abîmés.
- GB** Check quantity of elements and if they are not faulty.
- IT** Controllare la quantità e se gli elementi non sono danneggiati.
- D** Sie die Menge, und ob die Elemente nicht beschädigt sind.
- RU** Проверить количество, а также не повреждены ли детали.

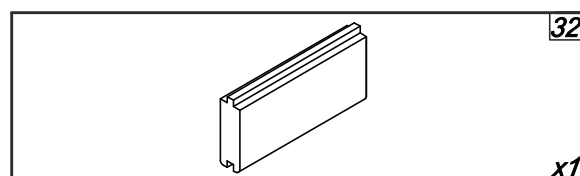
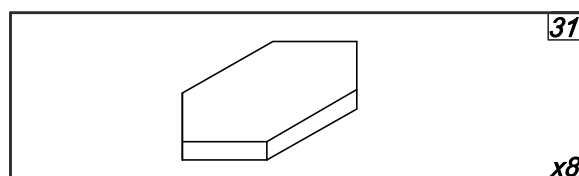
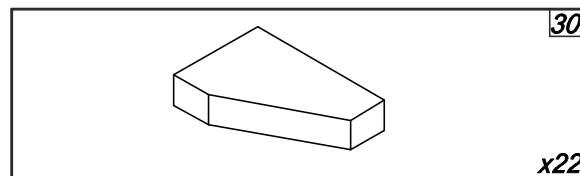
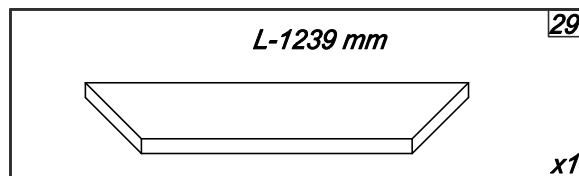
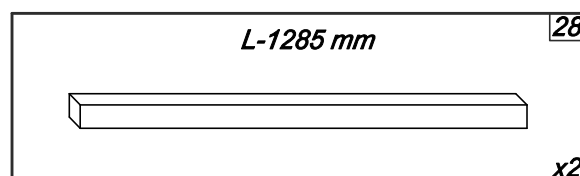
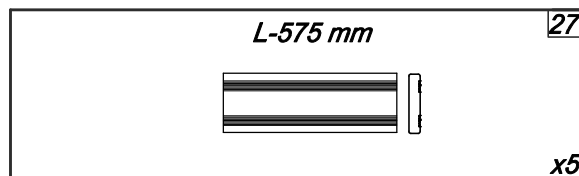
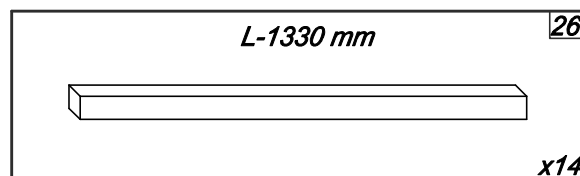
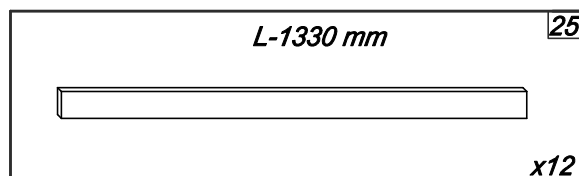
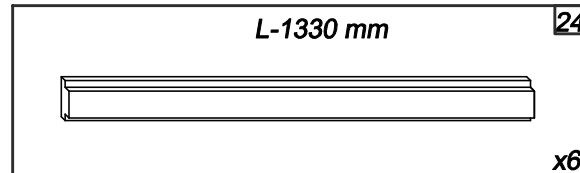
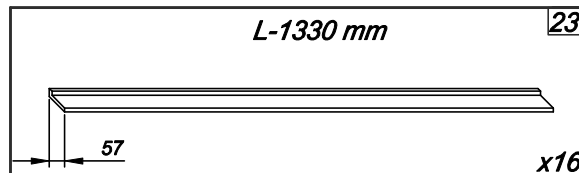
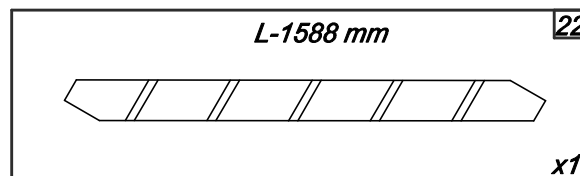
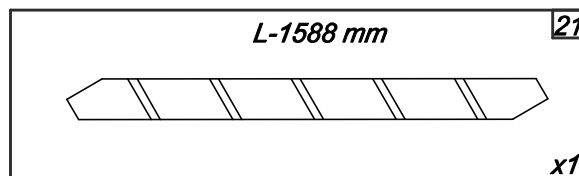
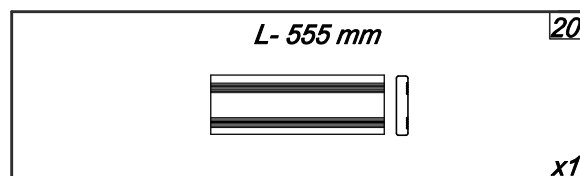
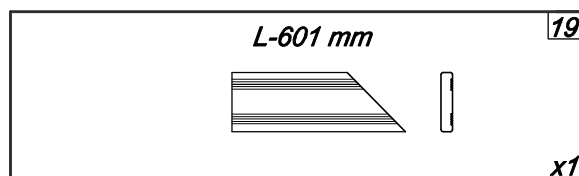
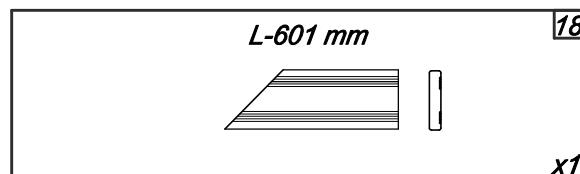
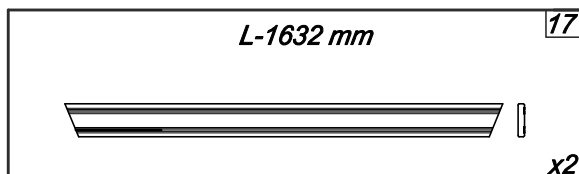
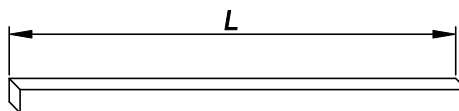

PL Okucia i osprzęt

GB Fittings and equipment

D Beschläge und Ausrüstung

FR Quincaillerie et l'équipement

IT Ferramenti e accessori

RU Фурнитура и оборудование



PL Sprawdź ilość.

FR Vérifiez la quantité.

GB Check quantity.

IT Controllare la quantità.

D Überprüfen Sie die Menge.

RU Проверить количество.

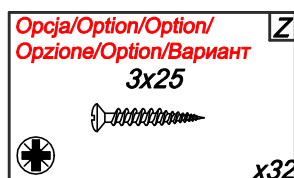
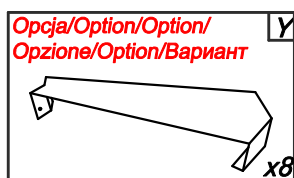
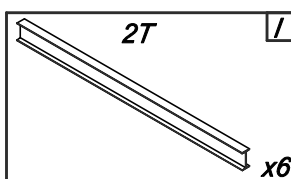
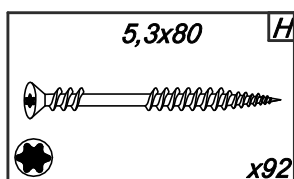
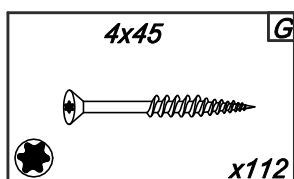
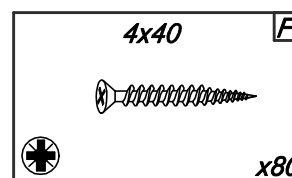
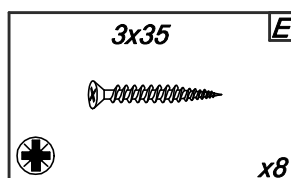
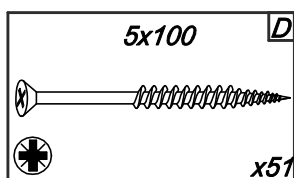
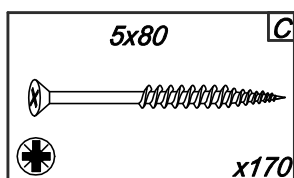
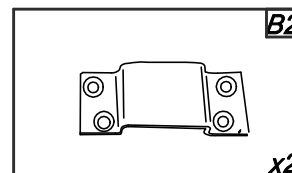
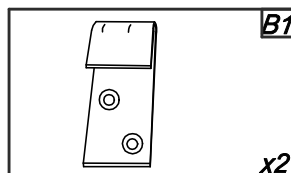
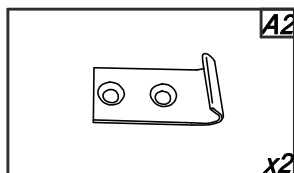
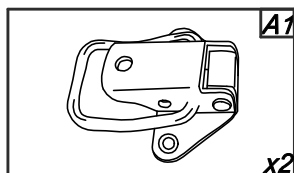

PL Narzędzia

GB Tools

D Werkzeuge

FR Les outils

IT Strumenti

RU Инструменты

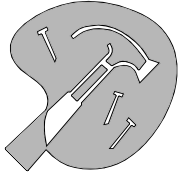

PL Przygotuj niezbędne narzędzia - niezawarte w zestawie.

FR Préparez les outils nécessaires - pas inclus.

GB Prepare essential tools- not included.

IT Preparare gli strumenti necessari - non inclusi nel set.

D Bereiten Sie notwendiges, nicht im Satz enthaltenes Werkzeug vor.

RU Приготовить необходимые инструменты - не содержатся в комплекте.

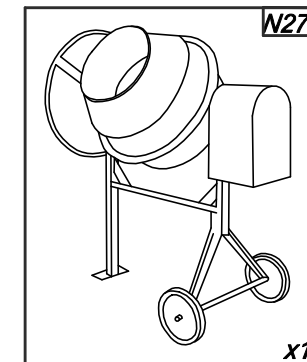
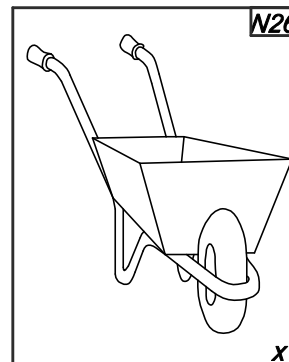
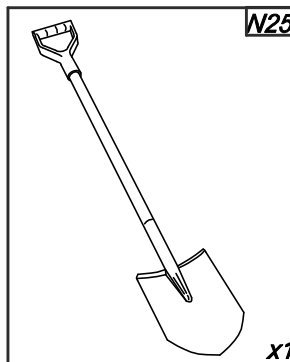
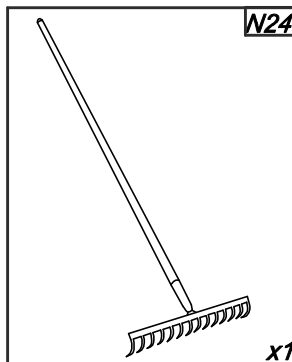
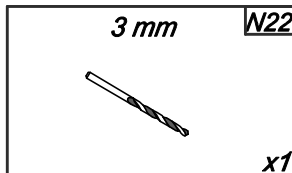
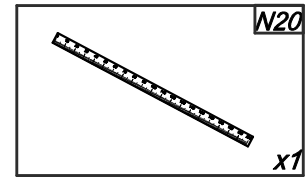
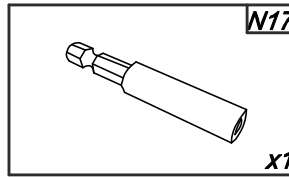
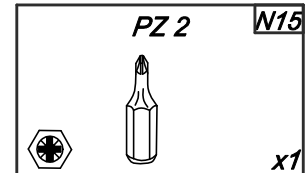
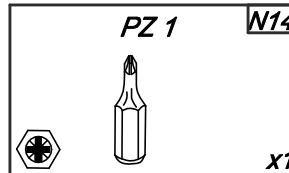
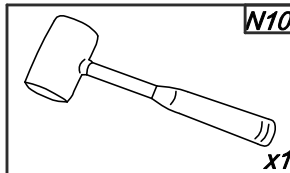
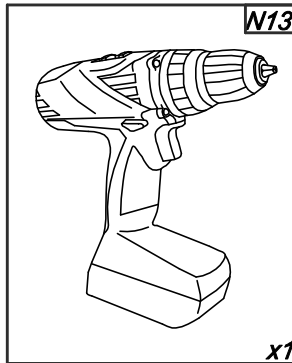
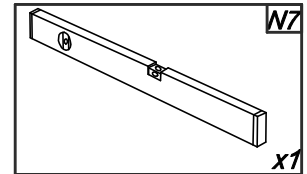
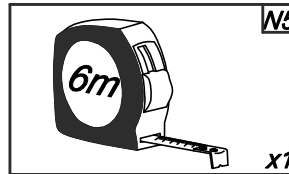
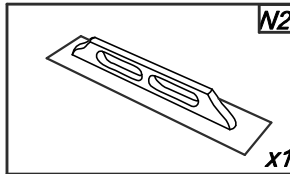
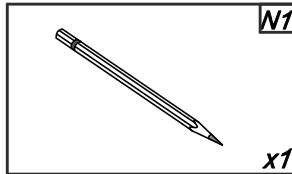

PL Podłoże

GB Ground

D Untergrund

FR Terrain

IT Suolo

RU база



PL Struktura basenu wkopanego musi być zabezpieczona folią budowlaną.

FR La structure bois enterrée doit être protégée contre une mauvaise influence des eaux à l'aide d'une feuille de construction.

GB Wooden structure if sunk in the ground must be protected with foundation membrane.

IT La struttura della piscina scavata deve essere protetta con un cellofan da costruzione.

D Struktur des eingegrabenen Schwimmbeckens soll mit Baufolie geschützt werden.

RU Структура вкапываемого бассейна должна быть защищена строительной пленкой.

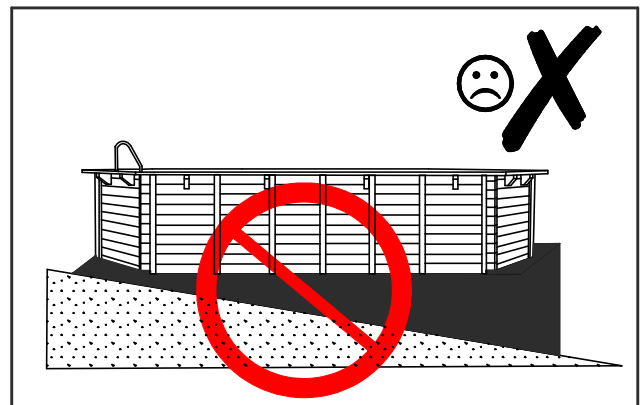
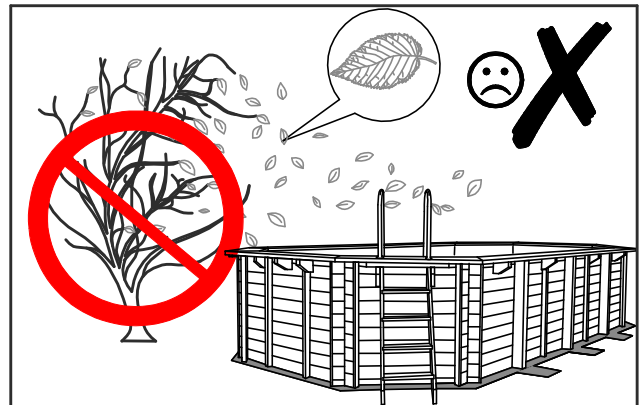
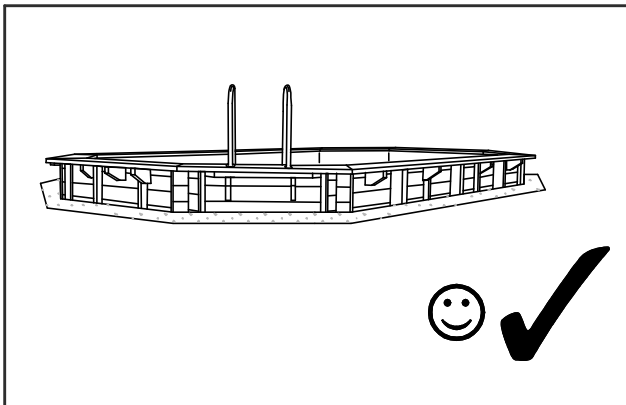
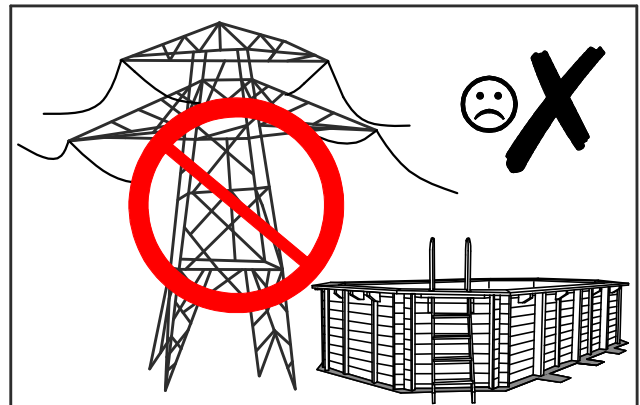
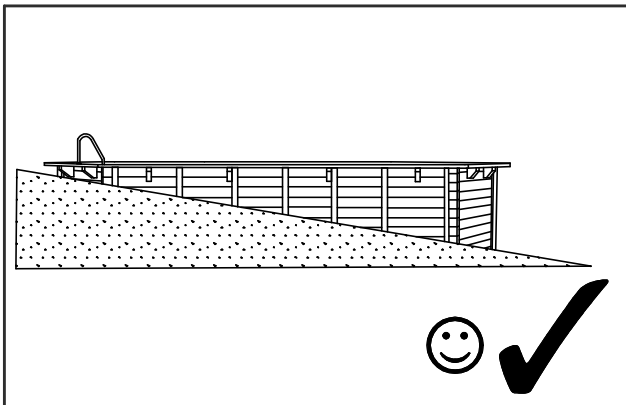
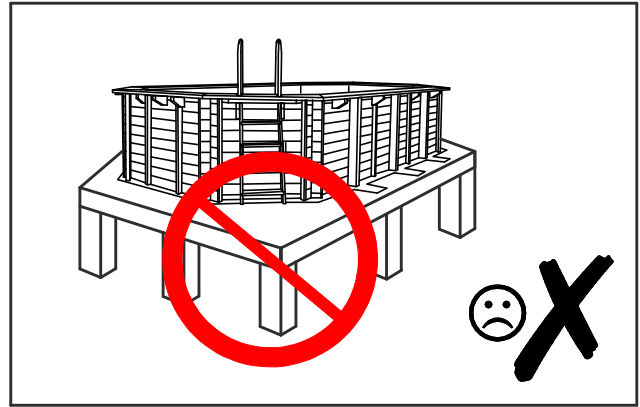
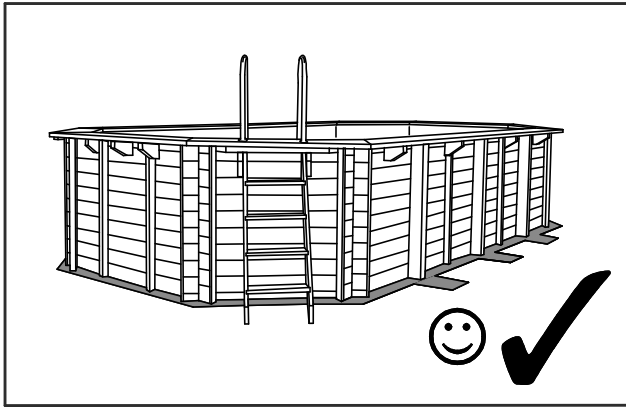

PL Podłoże

GB Ground

D Untergrund

FR Terrain

IT Suolo

RU база



PL Schemat rozmieszczenia słupków 2T (I) oraz przygotowania wylewki betonowej.

FR Le schéma de la disposition des poteaux métalliques 2T (I) et de la préparation de la dalle en béton.

GB Scheme of steel bearers 2T (I) arrangement, preparing concrete base.

IT Schematica dei pilastri 2T (I) e della preparazione di calcestruzzo.

D Schematische Darstellung von 2T - Säulen (I) und Vorbereitung des Betonestriches.

RU Схема размещения стоек 2Т (I) и подготовки бетонного основания.

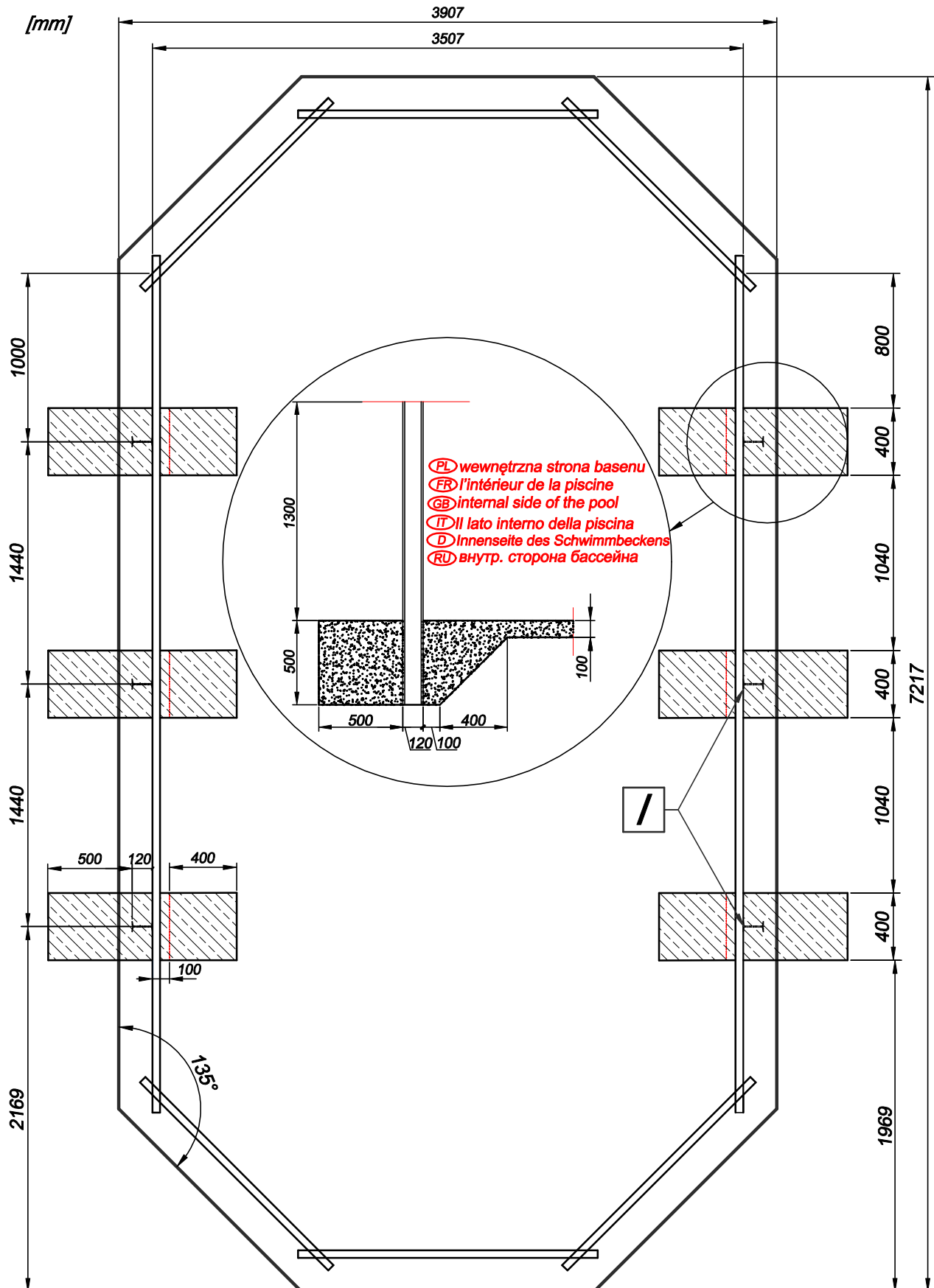

(PL) Podłoże

(GB) Ground

(D) Untergrund

(FR) Terrain

(IT) Suolo

(RU) база



(PL) Powierzchnia musi być twarda, płaska i wypoziomowana. Zastosuj cement fundamentowy.

(FR) Le terrain doit être rigoureusement plat, dur et de niveau. Utilisez le ciment de soubassement.

(GB) The surface must be firm, flat and leveled. Use cement for foundations.

(IT) La superficie deve essere solida, piana e livellata. Applicare il cemento per i fondamenti.

(D) Der Untergrund muss fest, flach und eben sein. Verwenden Sie das Zementfundament.

(RU) Поверхность должна быть твердой, плоской и равномерной. Применить цемент для фундаментов.

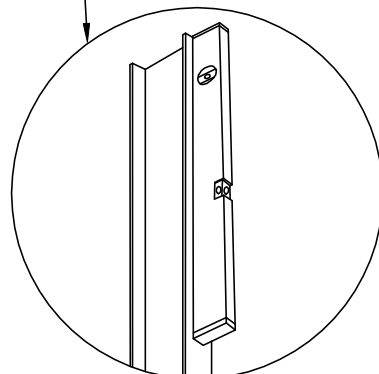
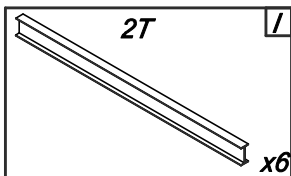
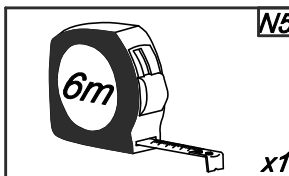
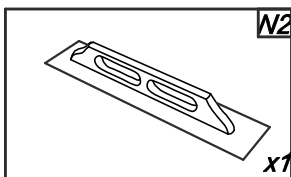
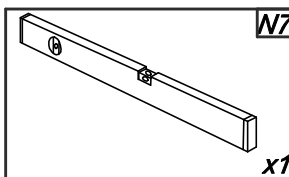
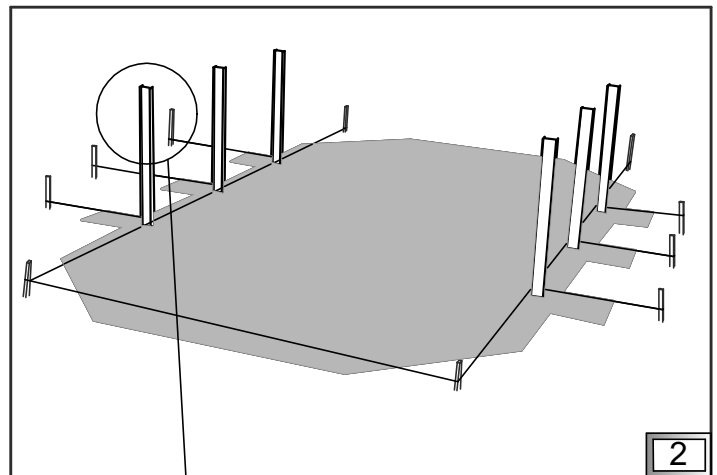
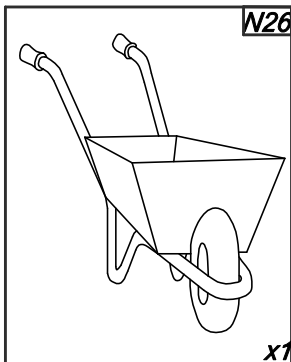
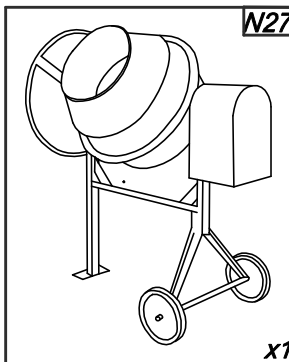
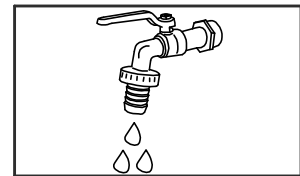
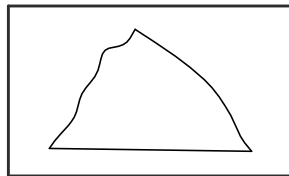
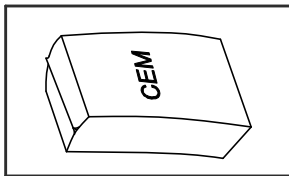
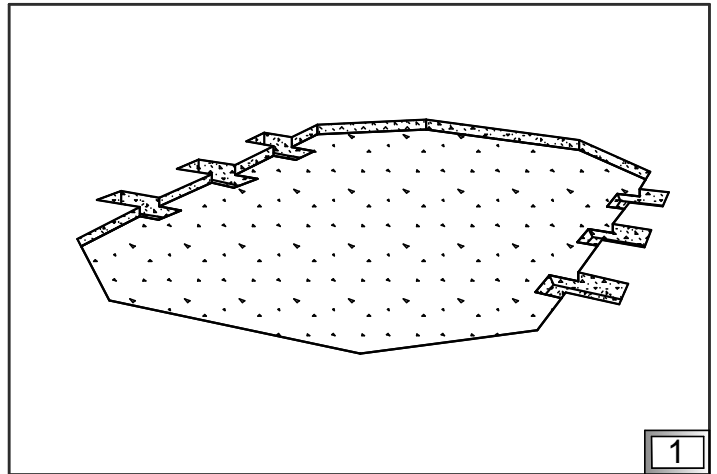
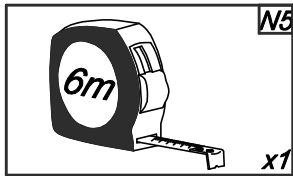
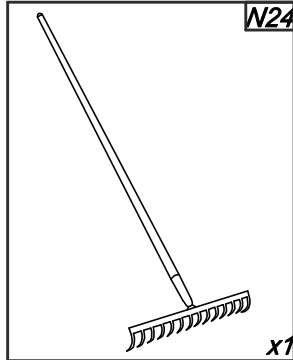
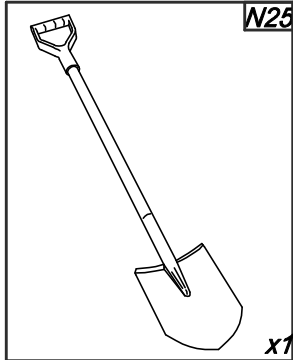

(PL) Struktura drewniana

(GB) Wooden structure

(D) Holzstruktur

(FR) La structure bois

(IT) Struttura in legno

(RU) Деревянная структура



(PL) Schemat rozmieszczenia warstw struktury. Ułożenie warstwy I.

(FR) Le schéma de la disposition des couches de la structure. La pose de la couche I.

(GB) Arrangement of structure's layers. Putting layer I.

(IT) Schematica degli strati della struttura. Posare lo strato I.

(D) Schema der Anordnung von Strukturschichten. Auflegen der I-Schichte.

(RU) Схема размещения слоев структуры. Укладка I слоя.

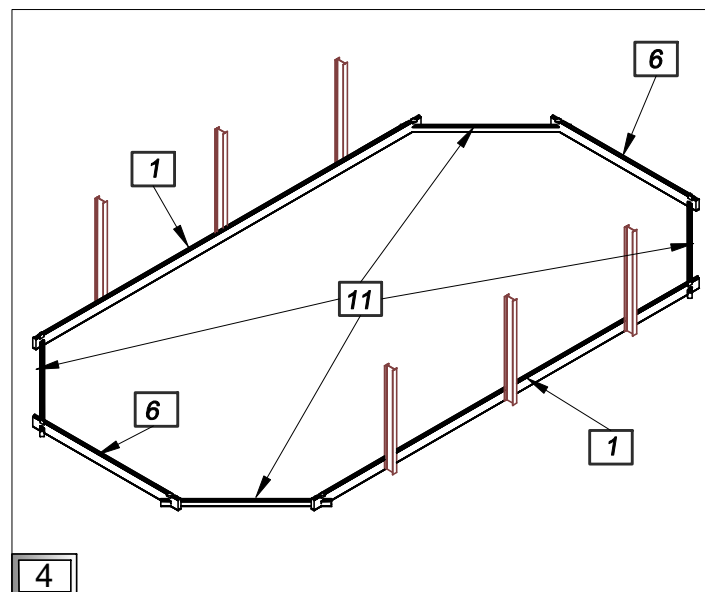
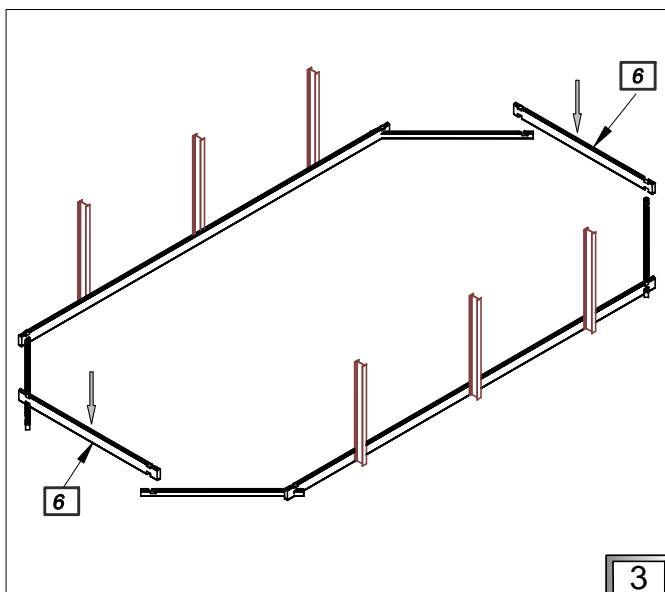
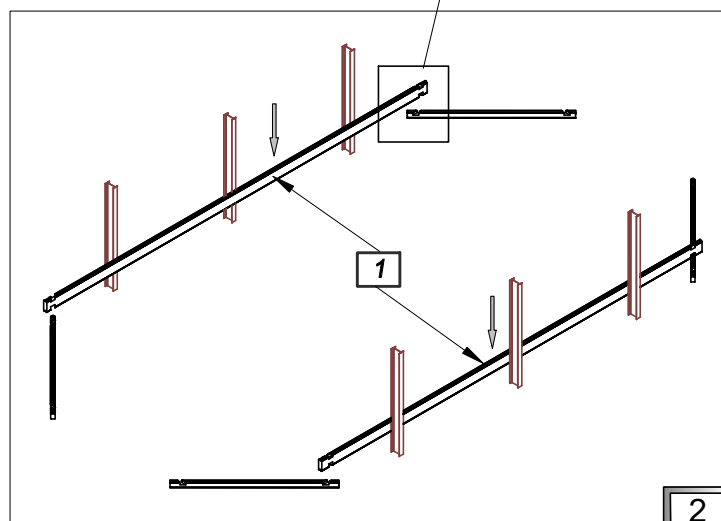
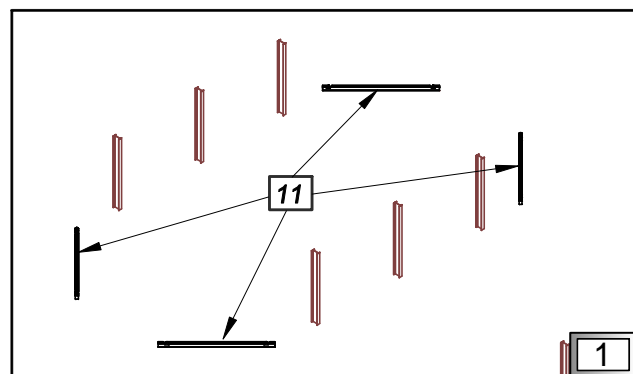
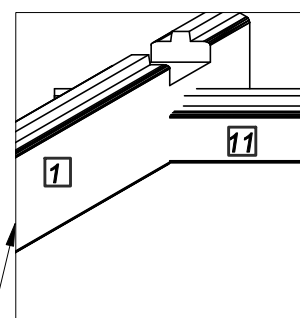
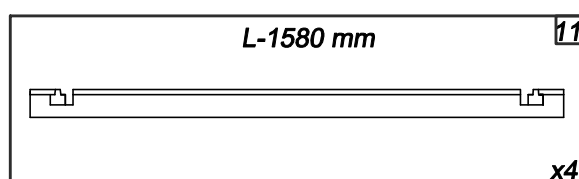
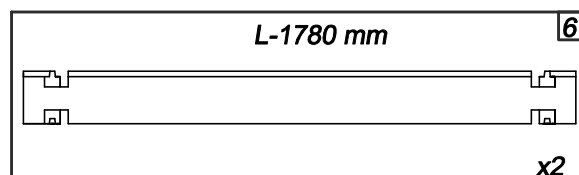
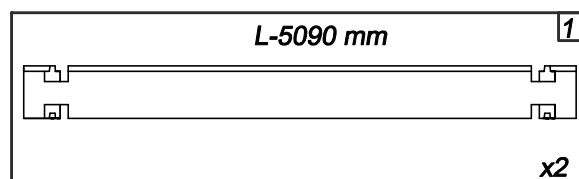
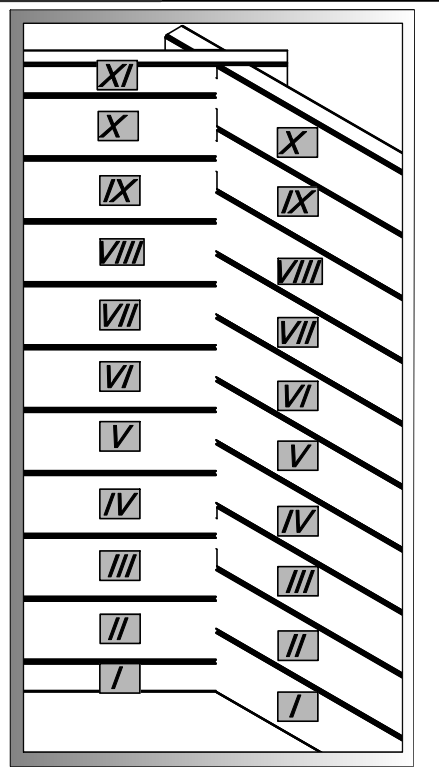

(PL) Struktura drewniana

(GB) Wooden structure

(D) Holzstruktur

(FR) La structure bois

(IT) Struttura in legno

(RU) Деревянная структура



(PL) Po ułożeniu każdej z warstw sprawdź przekątne D według rysunku.

(FR) Vérifiez les diagonales "D" après la pose de chaque tour.

(GB) After putting each layer check D diagonals according to the drawing.

(IT) Dopo la posa di ogni strato bisogna controllare diagonali D, secondo il disegno.

(D) Nach Verlegen von jeder Schicht kontrollieren Sie D-Diagonale nach Schema.

(RU) После укладки каждого слоя проверить диагонали D согласно рисунку.

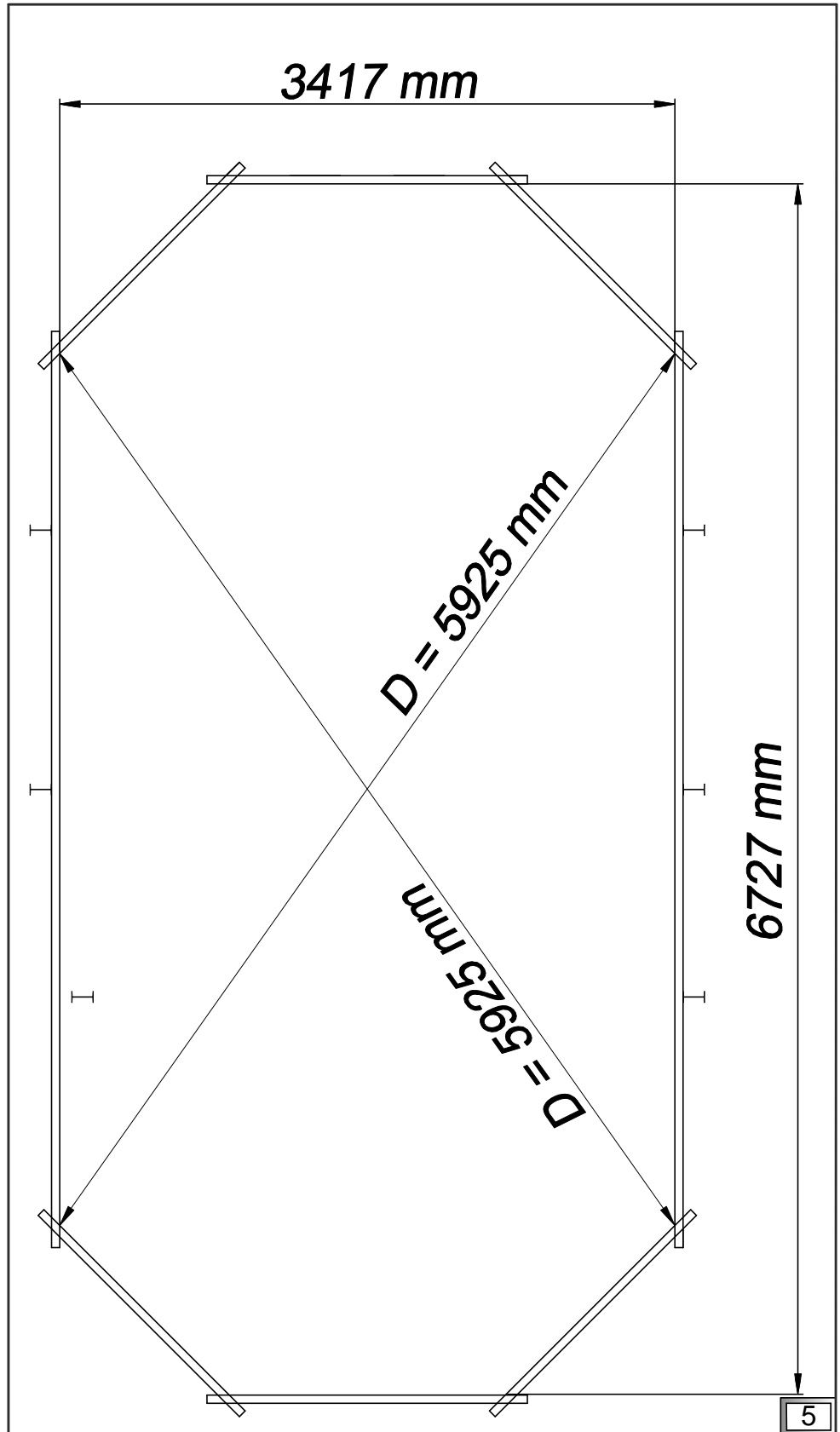
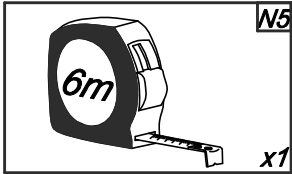

(PL) Struktura drewniana

(GB) Wooden structure

(D) Holzstruktur

(FR) La structure bois

(IT) Struttura in legno

(RU) Деревянная структура



(PL) Ułożenie kolejnych warstw. Sprawdzaj przekątną D po każdej ułożonej warstwie.

(FR) L'assemblage des couches suivantes. Vérifiez les diagonales "D" après la pose de chaque tour.

(GB) Putting next layers. Check D diagonals every layer.

(IT) La messa degli strati successivi. Trova la diagonale D dopo ogni strato.

(D) Verlegen der nachfolgenden Schichten. Nach Verlegen von jeder Schicht kontrollieren Sie die D-Diagonale.

(RU) Укладка очередных слоев. Проверять диагональ D после каждой укладки слоя.

II-III

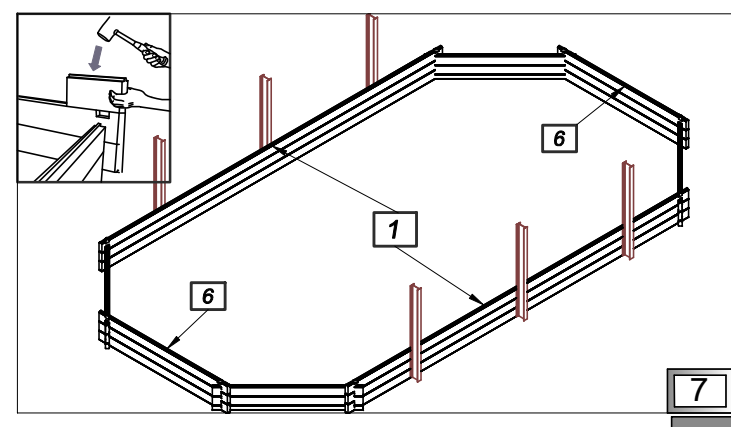
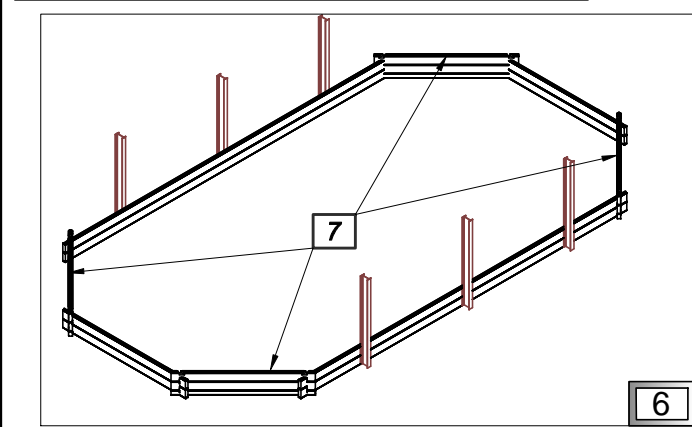
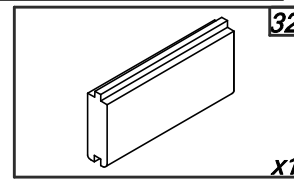
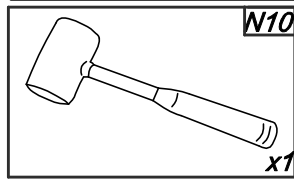
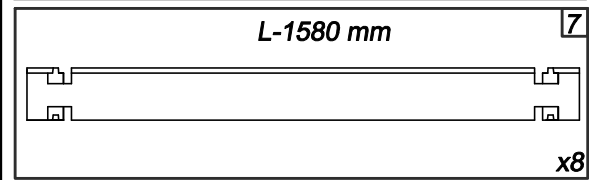
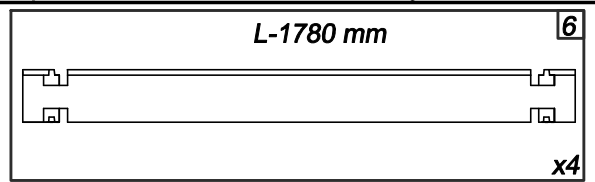
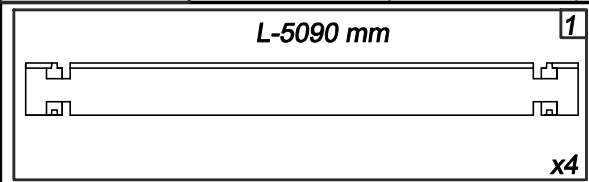

IV

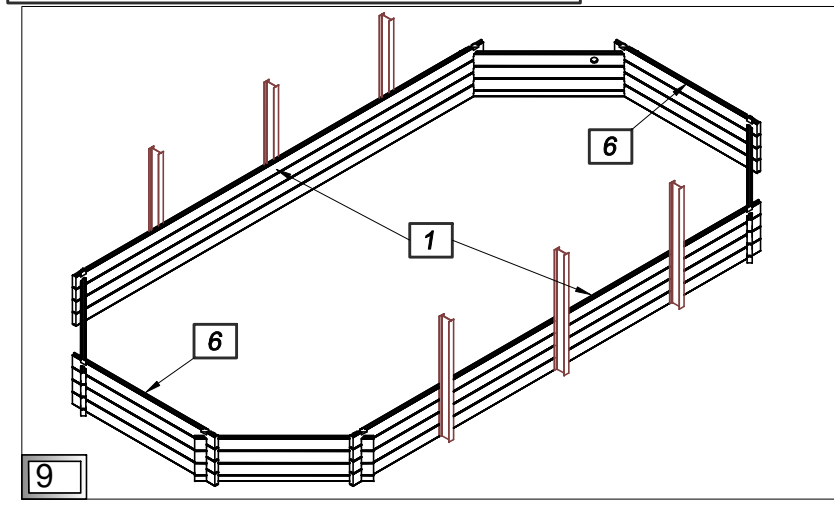
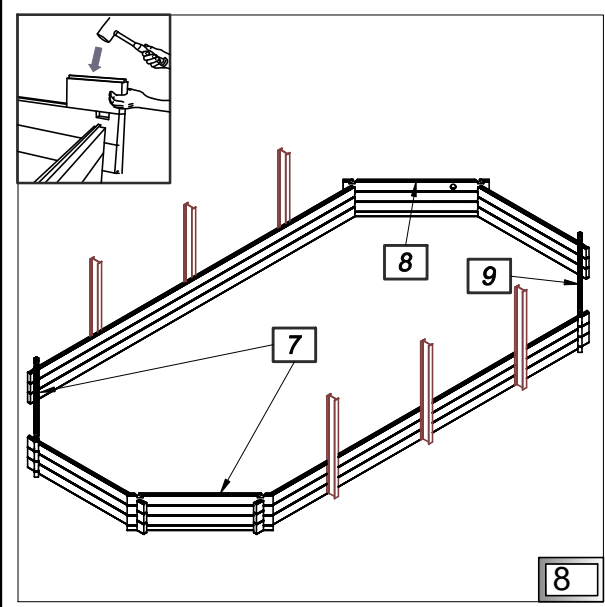
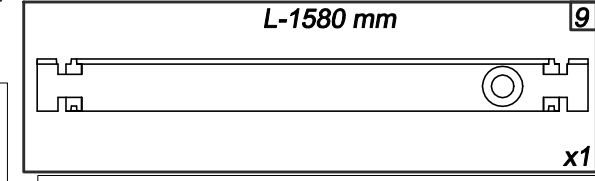
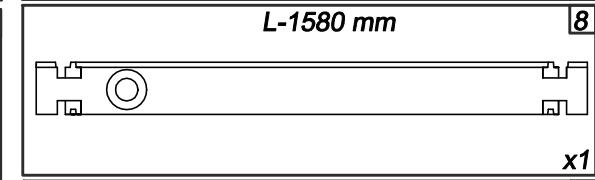
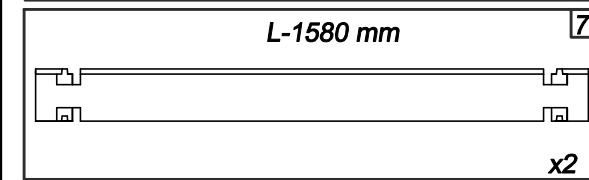
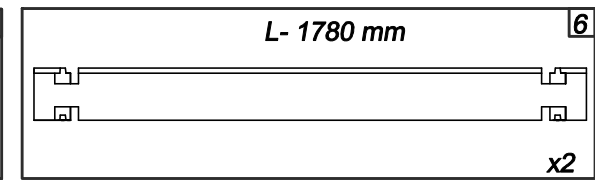
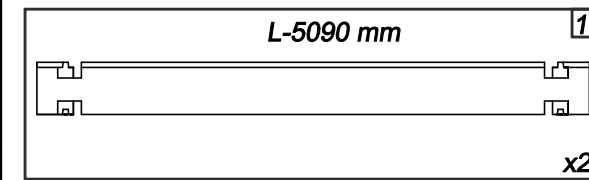

(PL) *Struktura drewniana*

(GB) *Wooden structure*

(D) *Holzstruktur*

(FR) *La structure bois*

(IT) *Struttura in legno*

(RU) *Деревянная структура*



(PL) *Ułożenie kolejnych warstw. Sprawdź przekątną D po każdej ułożonej warstwie.*

(FR) *L'assemblage des couches suivantes. Vérifiez les diagonales "D" après la pose de chaque tour.*

(GB) *Putting next layers. Check D diagonals every layer.*

(IT) *La messa degli strati successivi. Trova la diagonale D dopo ogni strato.*

(D) *Verlegen der nachfolgenden Schichten. Nach Verlegen von jeder Schicht kontrollieren Sie die D-Diagonale.*

(RU) *Укладка очередных слоев. Проверять диагональ D после каждой укладки слоя.*

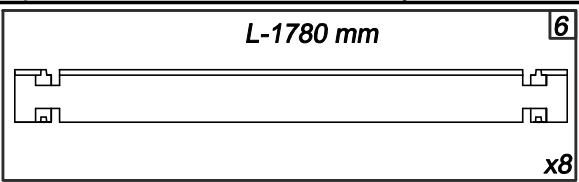
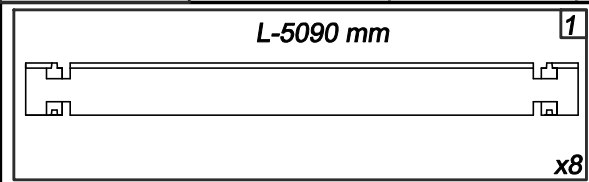

V-VIII

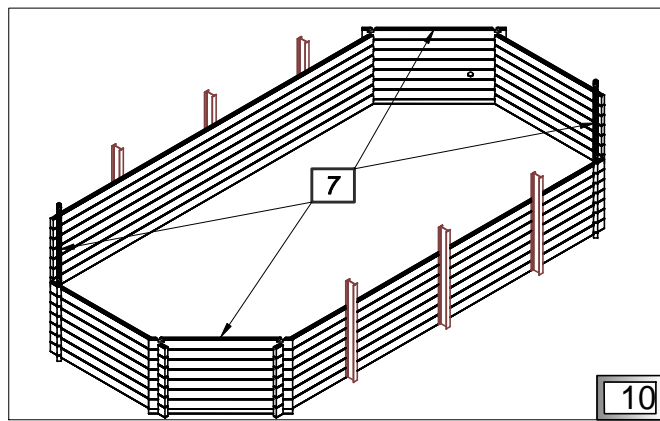
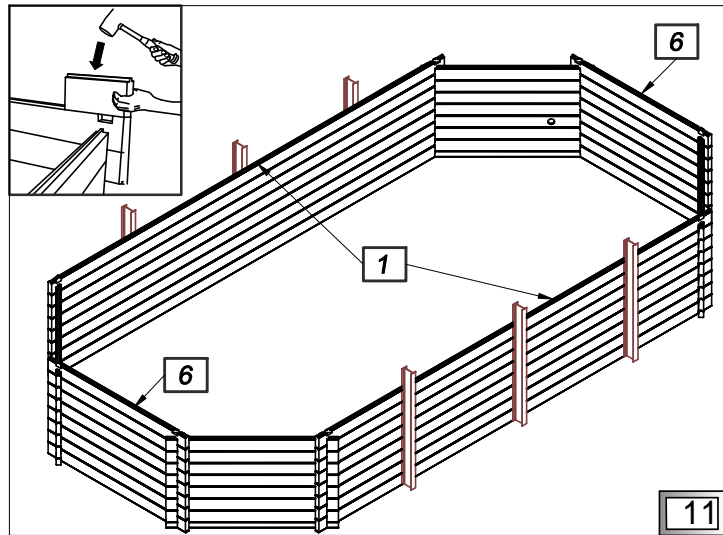
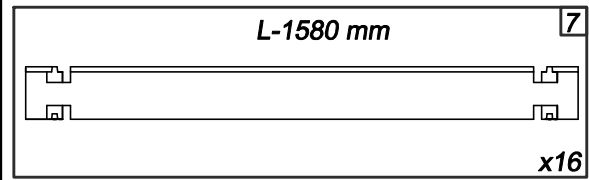

10

11

IX

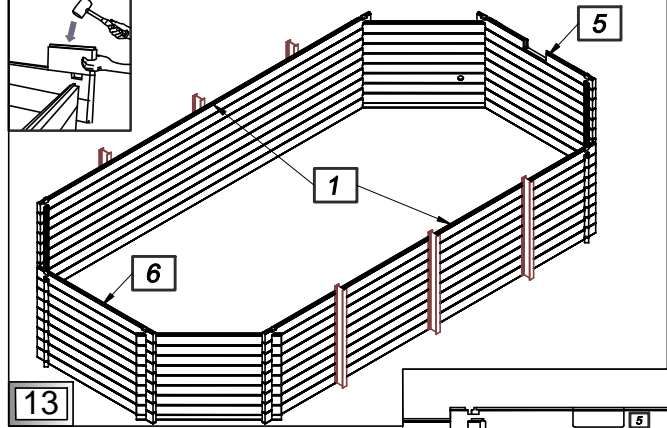
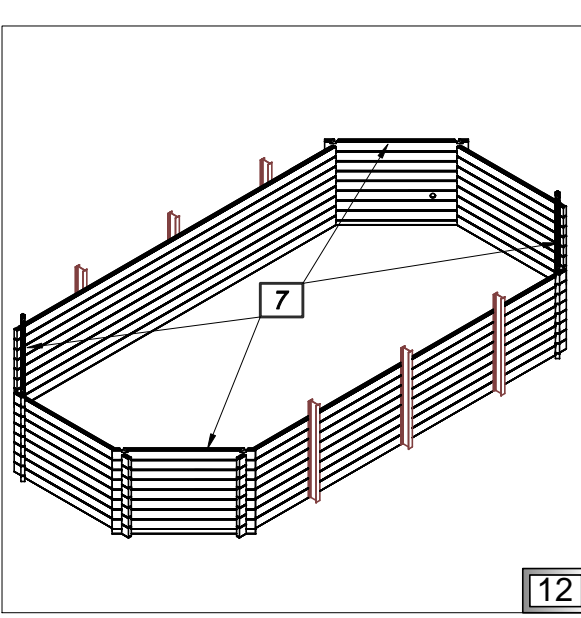
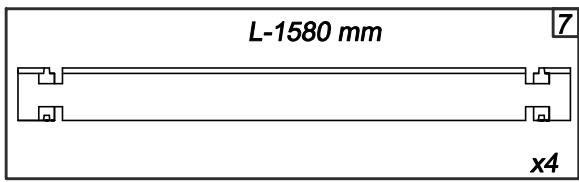
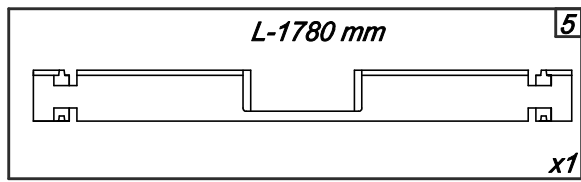
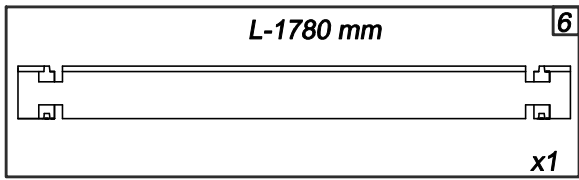
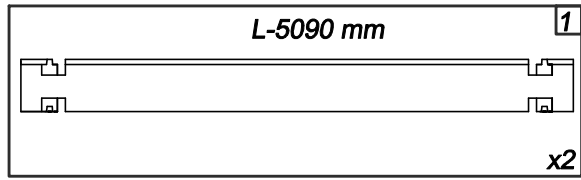

13

12

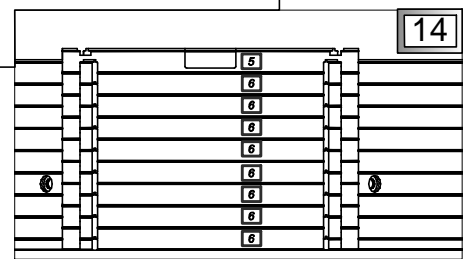

14

(PL) Struktura drewniana

(GB) Wooden structure

(D) Holzstruktur

(FR) La structure bois

(IT) Struttura in legno

(RU) Деревянная структура



- (PL)** Ułożenie kolejnych warstw.
- (FR)** La pose des couches suivantes.
- (GB)** Laying next layers.
- (IT)** La disposizione degli strati successivi.
- (D)** Auflegen der weiteren Schichten.
- (RU)** Укладка очередных слоев.

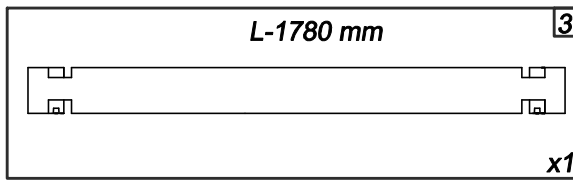
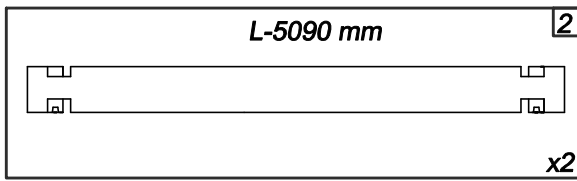

X

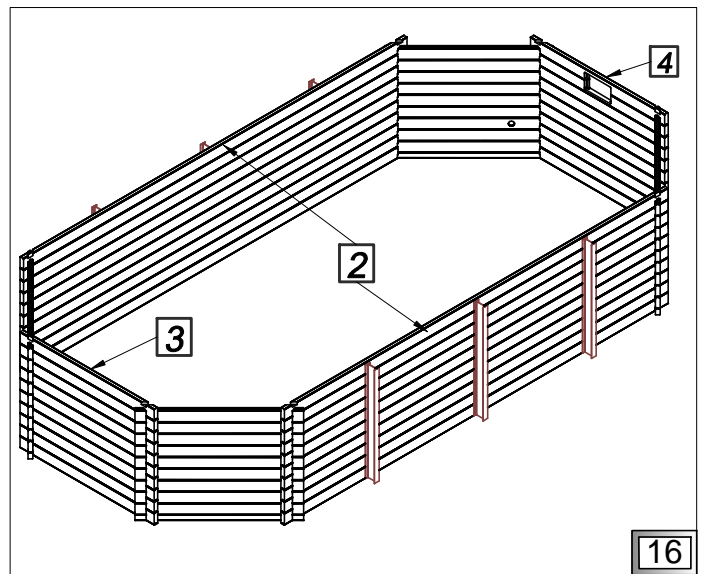
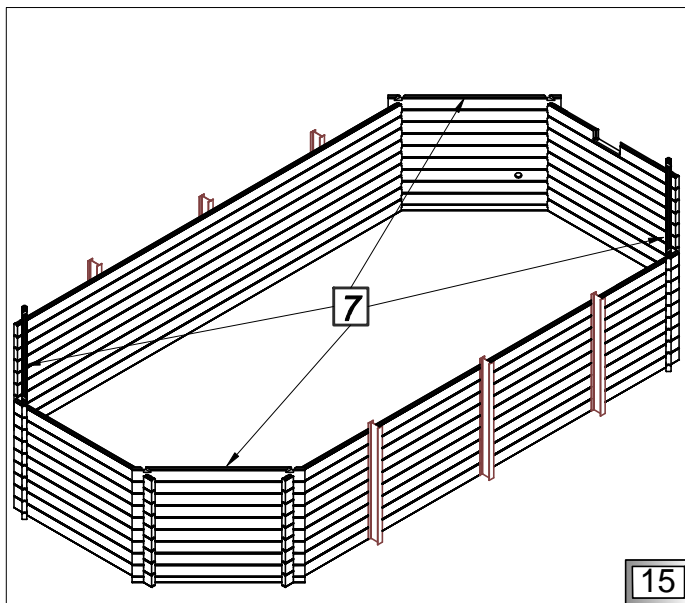
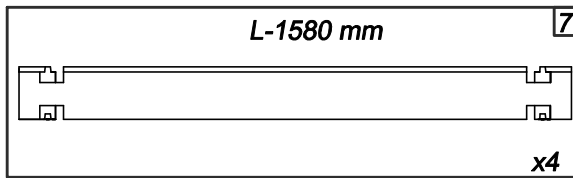
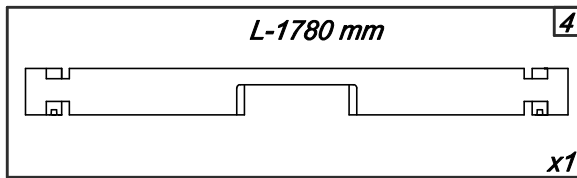

16

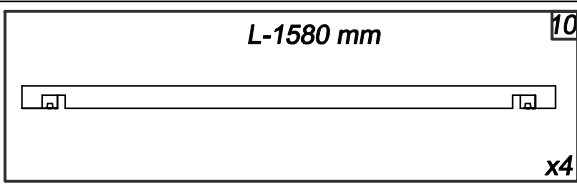

XI

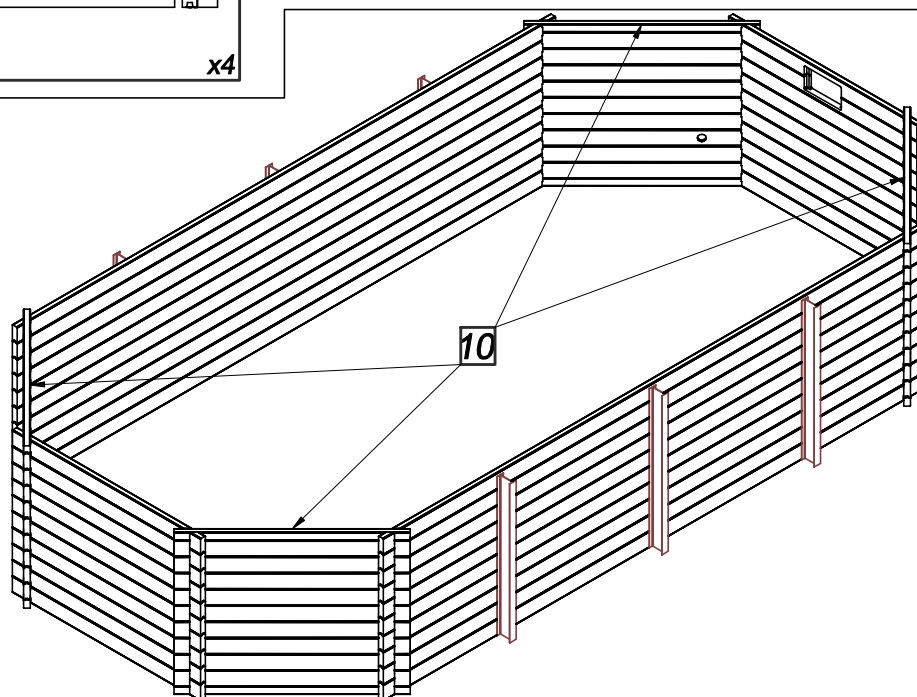
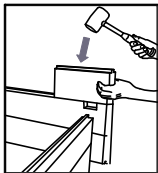

17

PL Struktura drewniana

GB Wooden structure

D Holzstruktur

FR La structure bois

IT Struttura in legno

RU Деревянная структура



PL Montaż wspornika schodów (29).

FR Le montage du renfort d'escalier (29).

GB Installation of stairs support (29).

IT Montaggio delle scale a sbalzo (29).

D Montage von Treppenstützen(29).

RU Монтаж кронштейна лестницы (29).

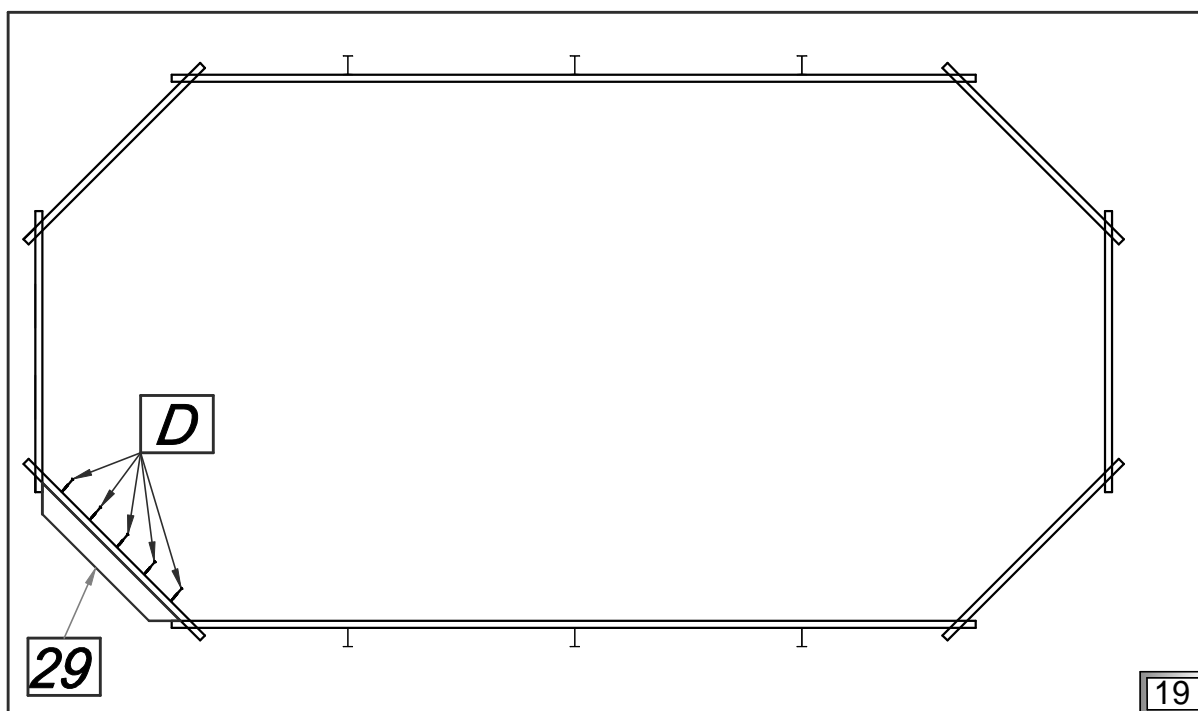
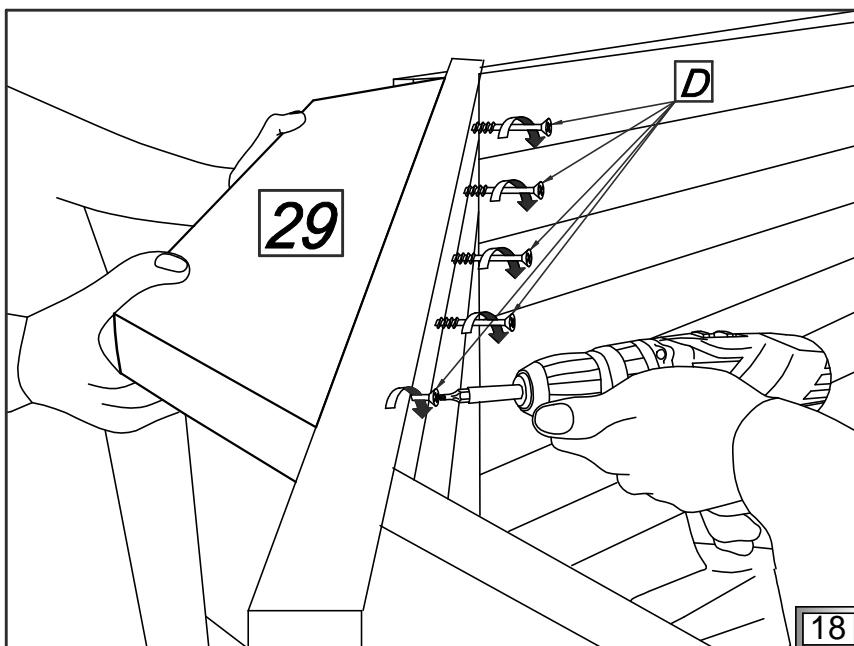
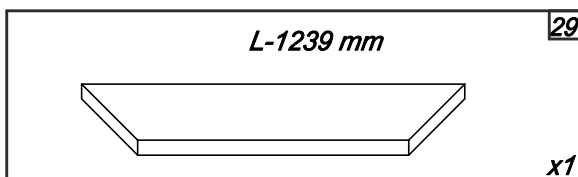
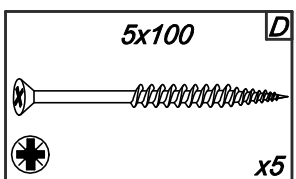
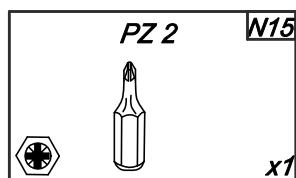
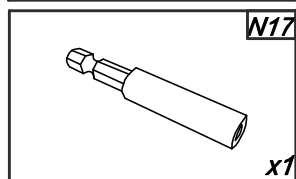
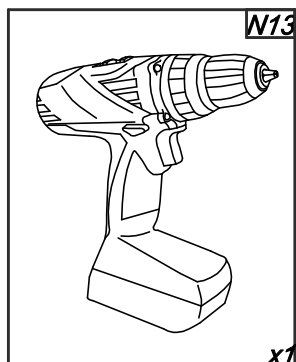

PL Struktura drewniana

GB Wooden structure

D Holzstruktur

FR La structure bois

IT Struttura in legno

RU Деревянная структура



PL Rozłożenie wsporników pionowych (26, 28) oraz konsol (30) według schematu.

FR La disposition des renforts verticaux (26, 28) et des supports des margelles (30) d'après le schéma.

GB Arrangement of vertical supports (26, 28) and consoles (30) according to the drawing.

IT La distribuzione degli sbalzi verticali (26, 28) e delle console (30), secondo lo schema.

D Verteilung der vertikalen Stützen (26, 28) und Konsolen (30) nach Schema.

RU Размещение вертикальных кронштейнов (26, 28) и консолей (30) согласно схеме.

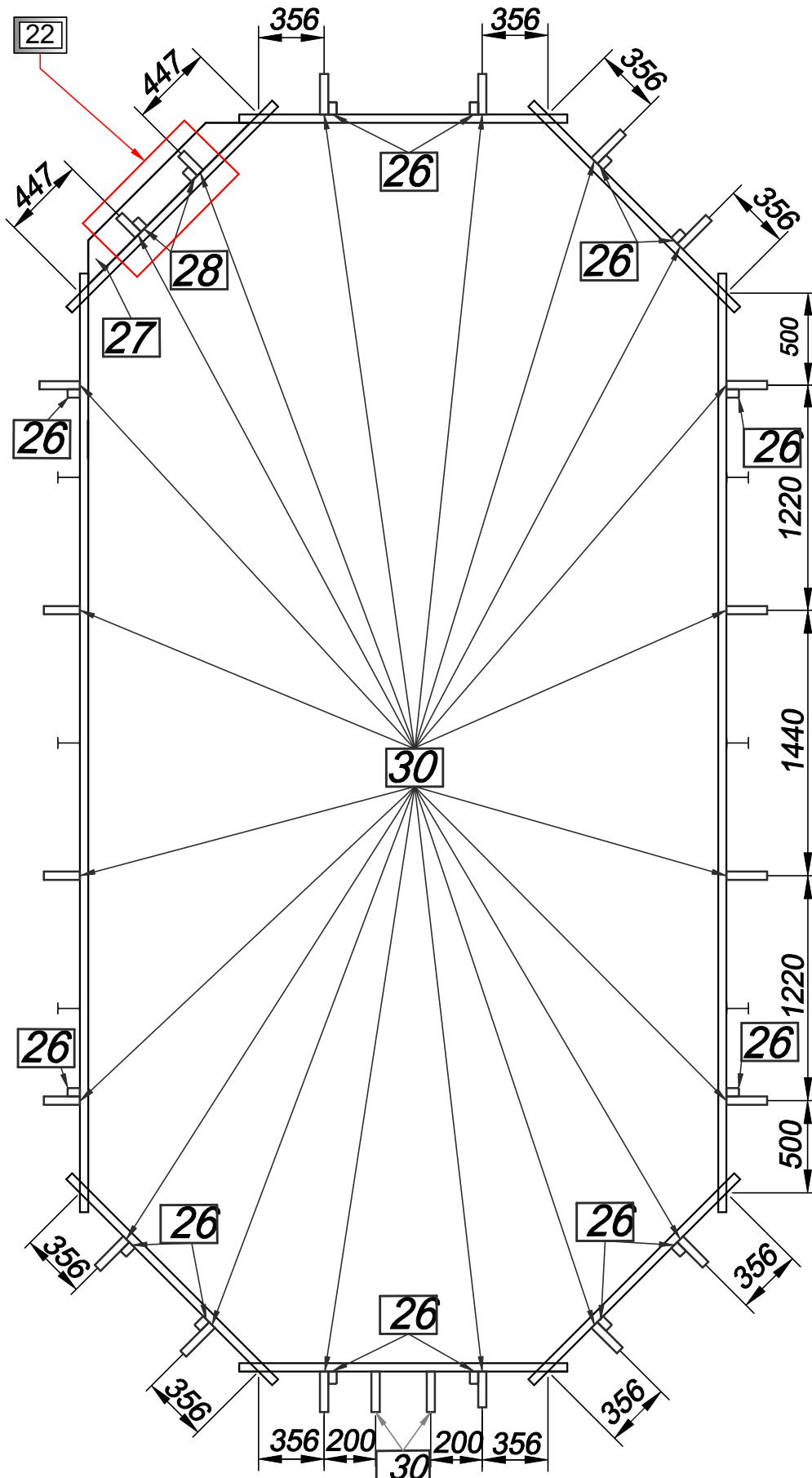

PL Struktura drewniana

GB Wooden structure

D Holzstruktur

FR La structure bois

IT Struttura in legno

RU Деревянная структура



PL Montaż konsol (30). Konsole montowane pod wspornikiem schodów (29) według rysunku 22.

FR Le montage des supports des margelles (30). Montez les supports des margelles sous un renfort d'escalier (29) d'après le dessin 22.

GB Installation of consoles (30). Consoles under ladder support (29) installed according to the drawing 22.

IT Il montaggio di console (30). Console sono montate sotto lo sbalzo della scala (29), come mostrato sul disegno 22.

D Konsolenmontage (30). Die Konsolen werden unter den Treppenstützen (29) nach Abb 22 montiert.

RU Монтаж консолей (30). Консоли устанавливаются под кронштейном лестницы (29) согласно рис. 22.

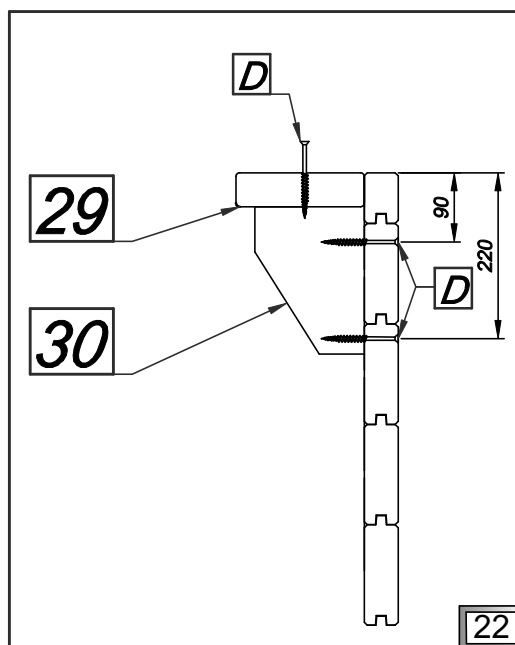
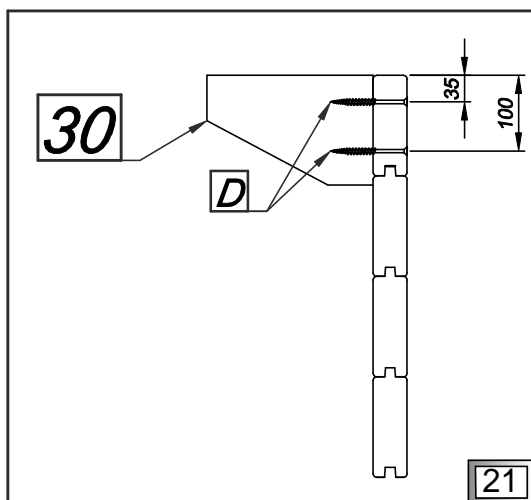
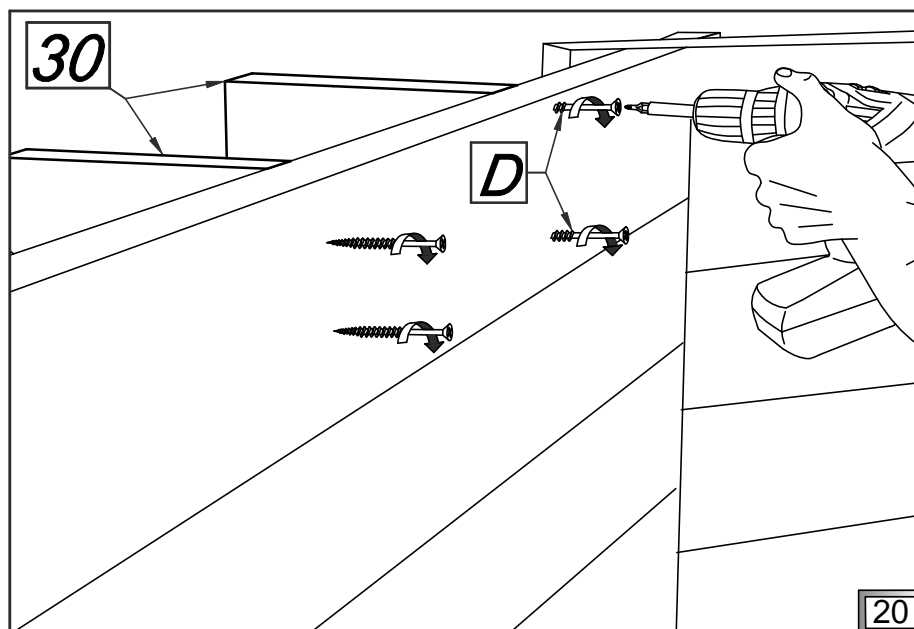
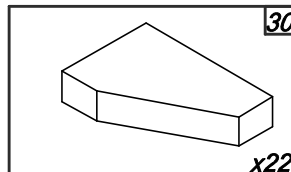
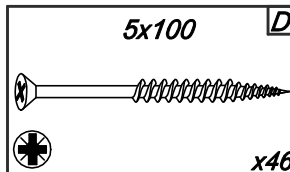
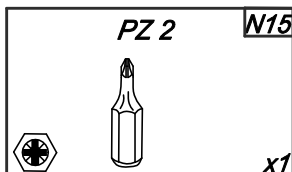
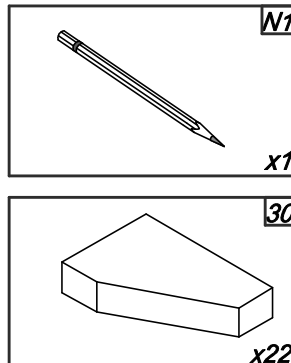
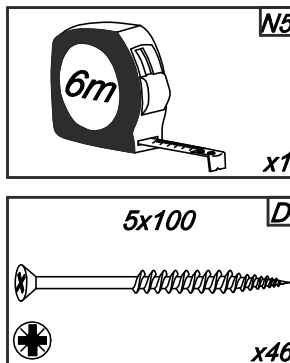
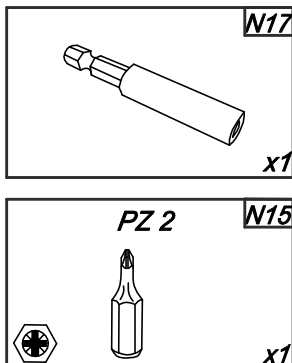
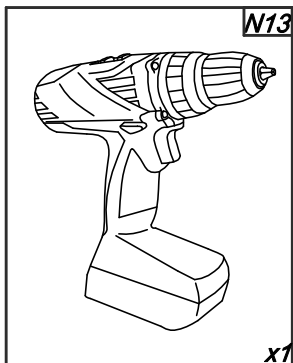

PL Struktura drewniana

GB Wooden structure

D Holzstruktur

FR La structure bois

IT Struttura in legno

RU Деревянная структура



PL Montaż wsporników pionowych (26). Wkręty rozmieszczaj według rysunku 24.

FR Le montage des renforts verticaux (26). La disposition des vis d'après le dessin 24.

GB Installation of vertical supports (26). Arrange screws according to the drawing 24.

IT Montaggio degli sbalzi verticali (26). Mettere viti secondo il disegno 24.

D Montage von vertikalen Stützen (26). Schrauben sind nach Abb 24 angebracht.

RU Монтаж вертикальных кронштейнов (26). Винты размещаются согласно рис. 24.

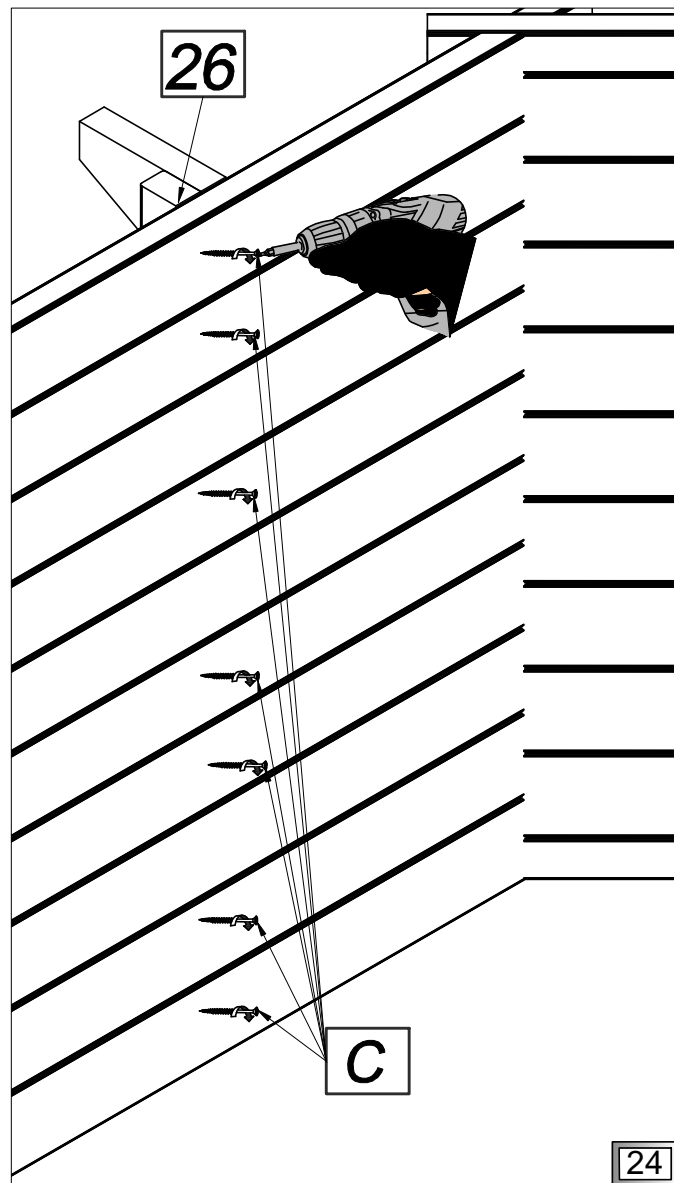
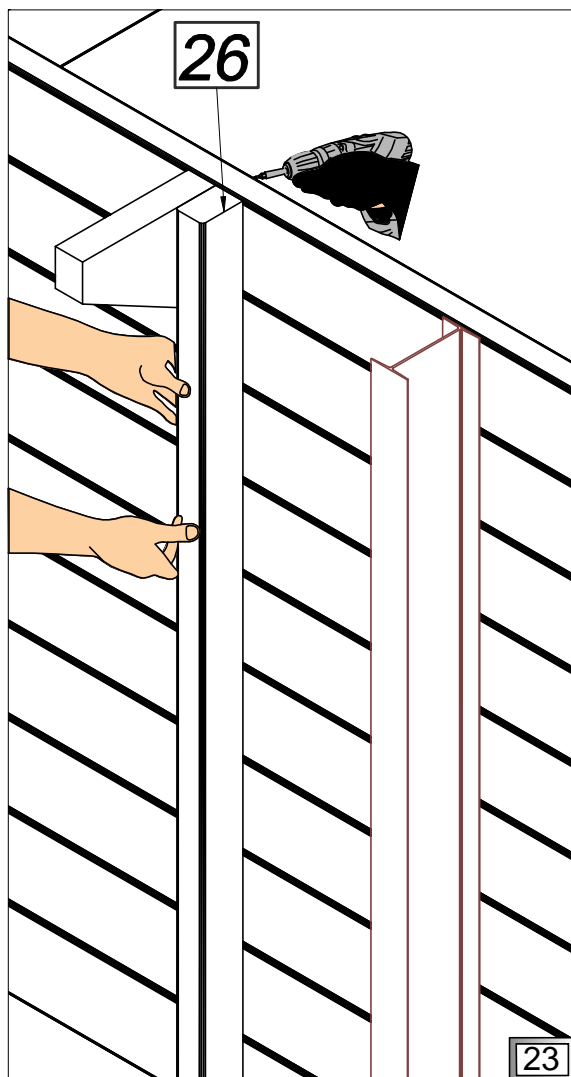
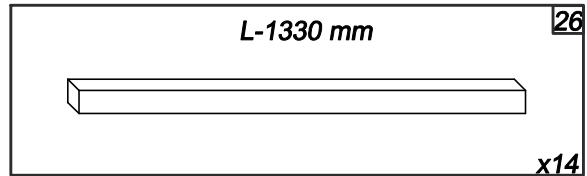
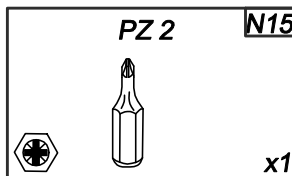
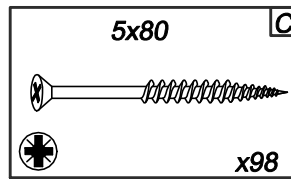
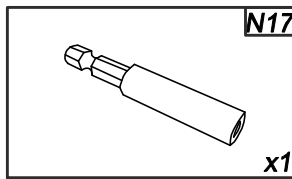
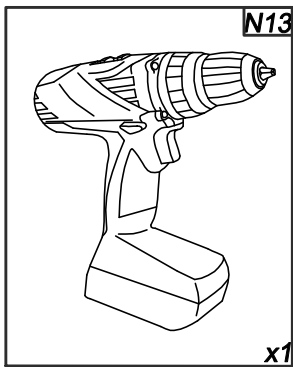

PL Struktura drewniana

GB Wooden structure

D Holzstruktur

FR La structure bois

IT Struttura in legno

RU Деревянная структура



PL Montaż wsporników pionowych (28) pod wspornikiem schodów 29.

FR Le montage des renforts verticaux (28) sous un renfort d'escalier (29).

GB Installation of vertical supports (28) under the ladder support (29).

IT Montaggio degli sbalzi verticali (28) sotto lo sbalzo delle scale (29).

D Montage von vertikalen Stützen (28) unter den Treppenstützen (29).

RU Монтаж вертикальных кронштейнов (28) под кронштейном лестницы (29).

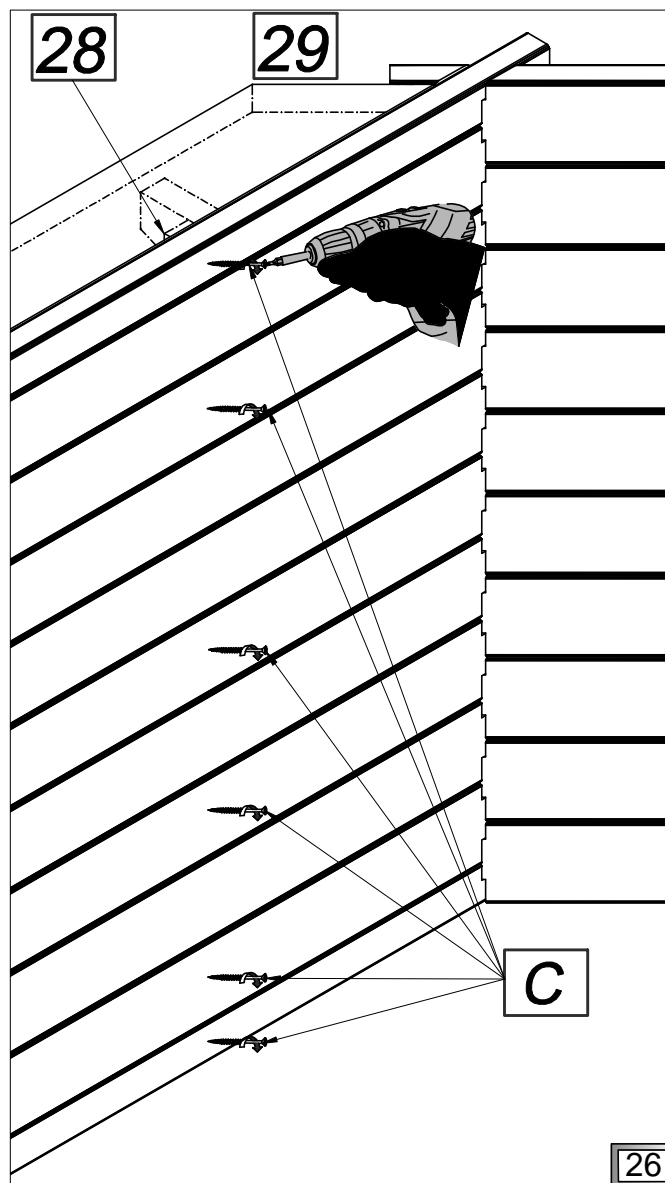
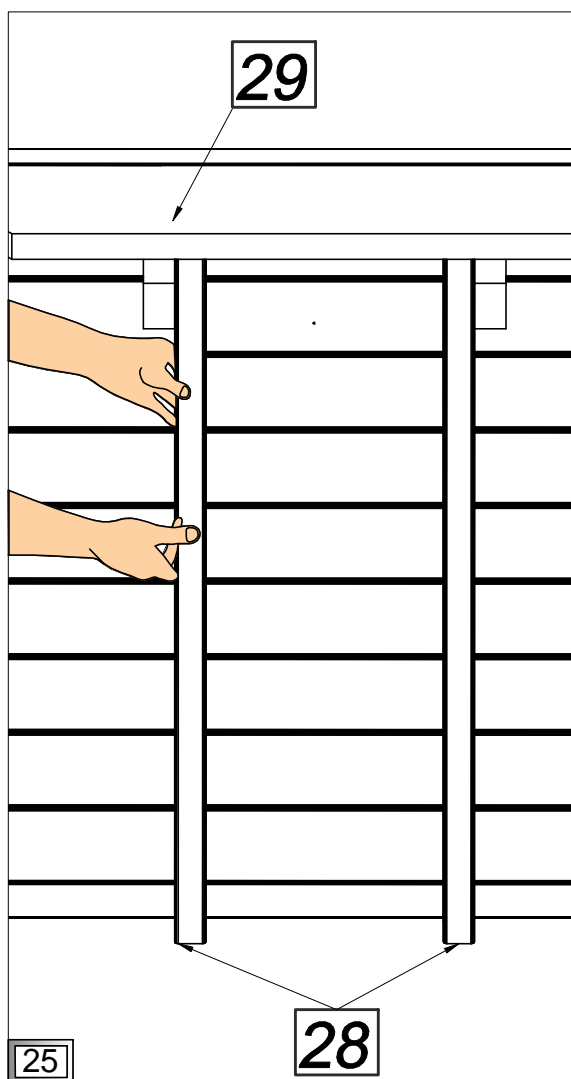
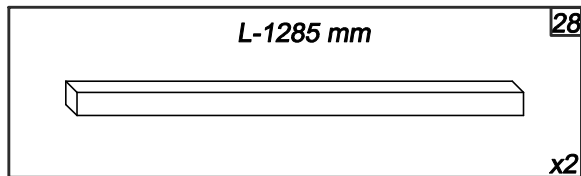
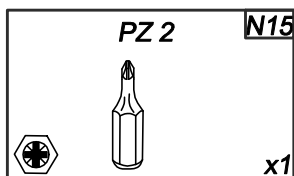
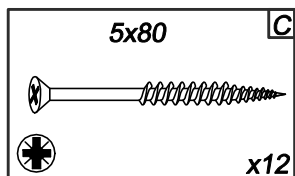
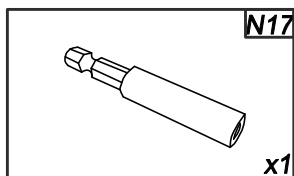
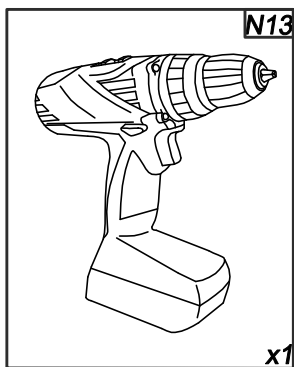

PL Struktura drewniana

GB Wooden structure

D Holzstruktur

FR La structure bois

IT Struttura in legno

RU Деревянная структура



- PL** Montaż maskownicy L 57 mm (23).
- FR** Le montage des caches L 57 mm (23).
- GB** Installation of the masking element L 57 mm (23).
- IT** Montaggio del mascherino L 57 mm (23).
- D** Montage der Abdeckung L 57 mm (23).
- RU** Монтаж маскировочного экрана L 57 мм (23).

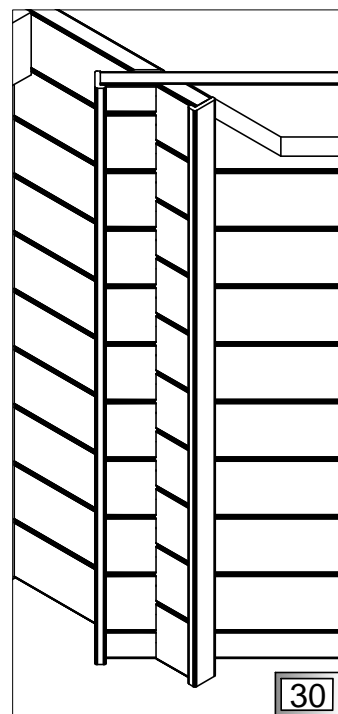
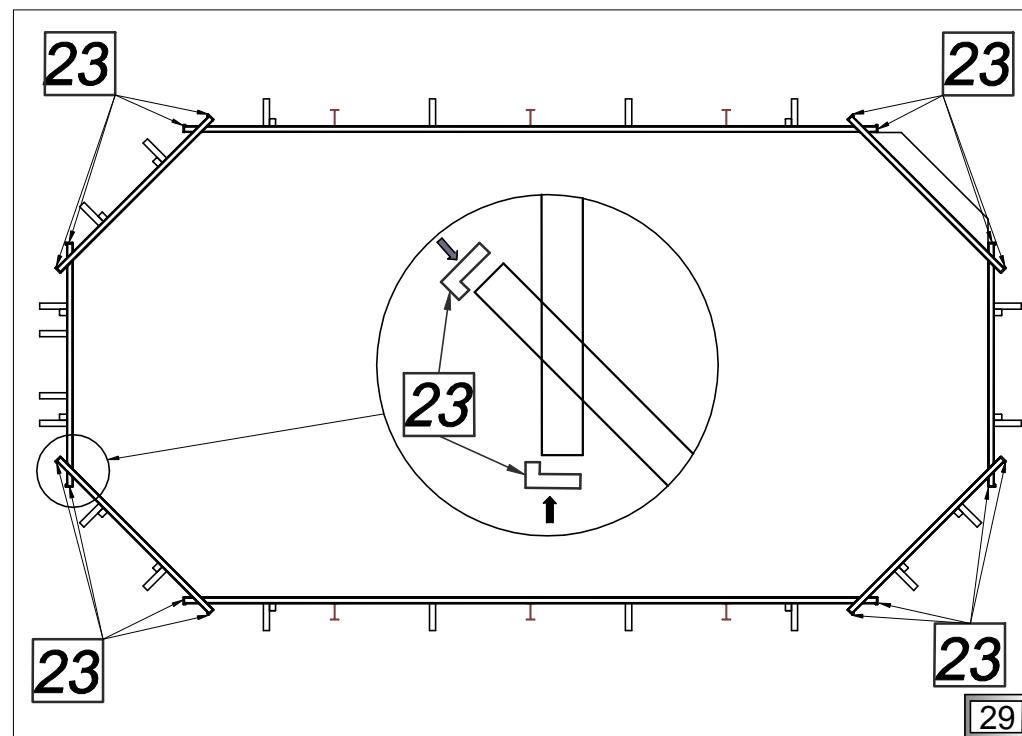
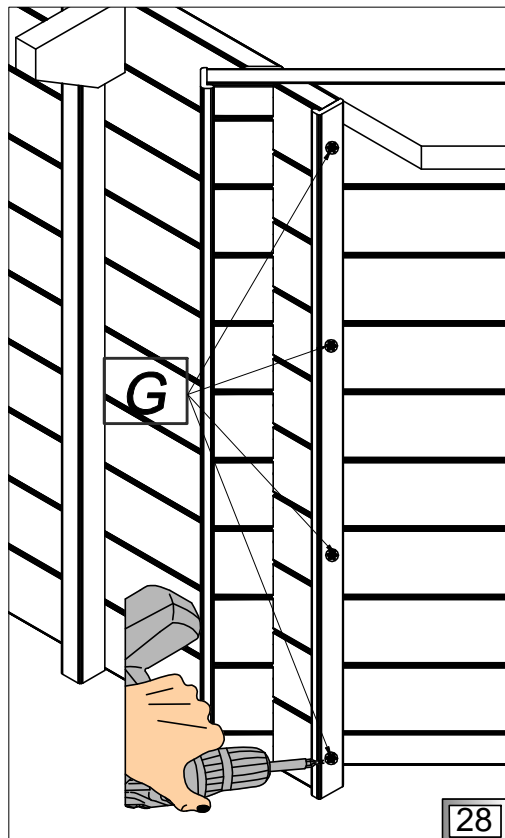
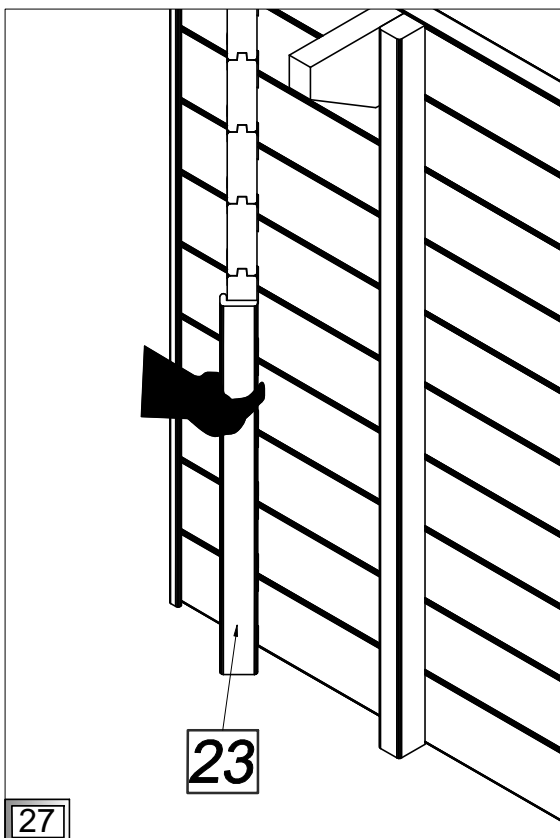
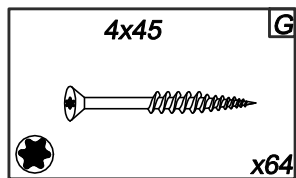
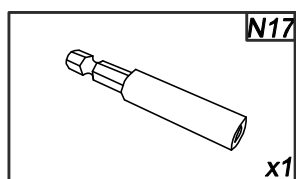
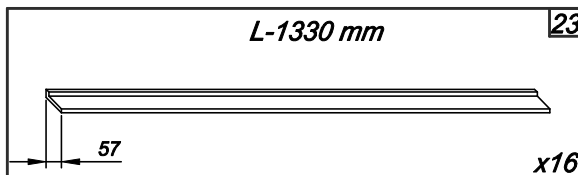
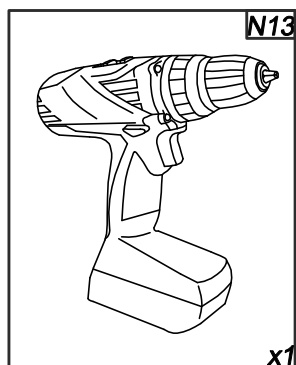

PL Struktura drewniana

GB Wooden structure

D Holzstruktur

FR La structure bois

IT Struttura in legno

RU Деревянная структура



PL Maskowanie słupków metalowych 2T (I) maskownicami (24,25).

FR La fixation des caches (24,25) pour les poteaux métalliques 2T (I)..

GB Covering steel bars 2T (I) with masking elements (24,25).

IT Mascherare i pilastri di metallo 2T (I) con i mascherini (24,25).

D Verdeckung von 2T-Metallsäulen (I) mit Abdeckungen (24,25).

RU Маскировка металлических стоек 2Т (I) маскировочными экранами (24,25).

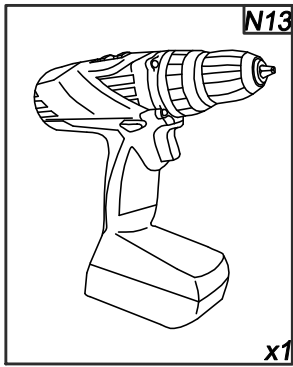

N13

x1

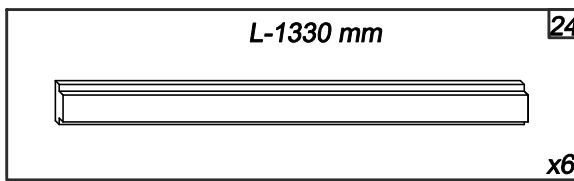

L-1330 mm

x6

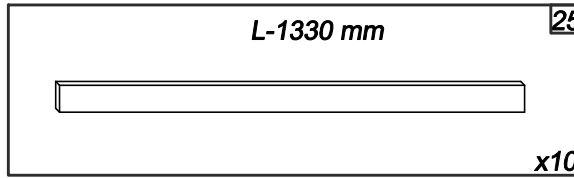

L-1330 mm

x10

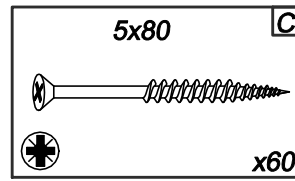

5x80

x60

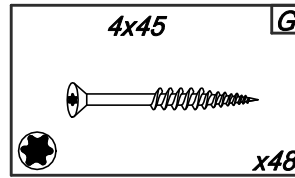

4x45

x48

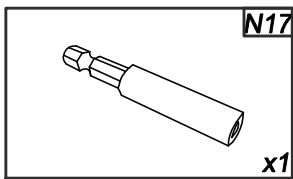

N17

x1

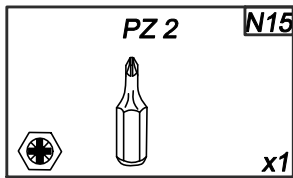

PZ 2

N15

x1

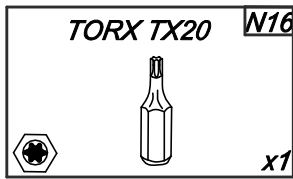

TORX TX20

N16

x1

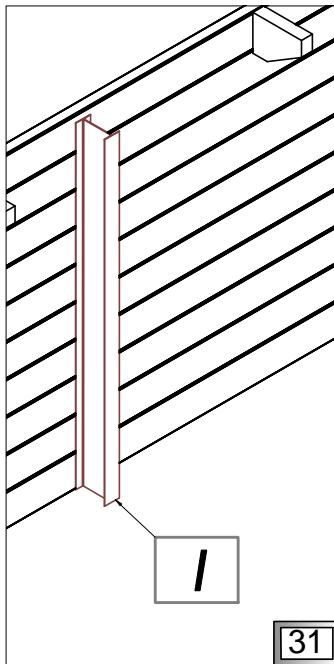

I

31

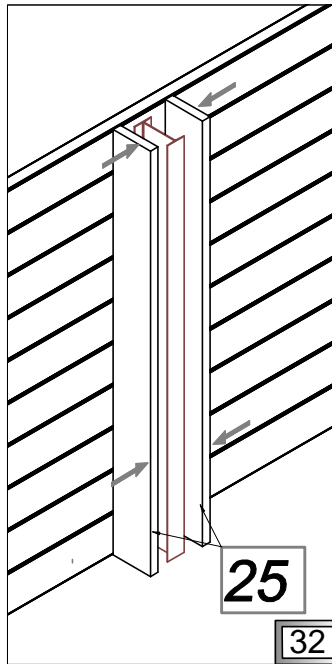

25

32

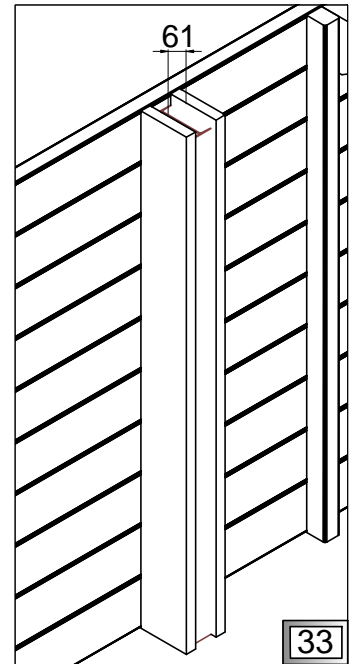

61

33

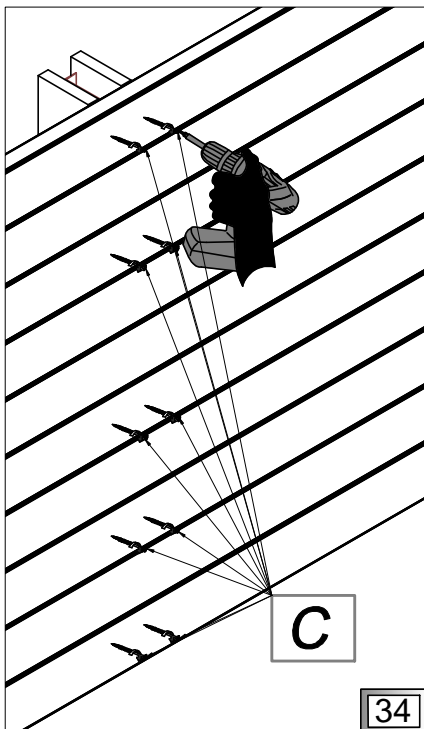

C

34

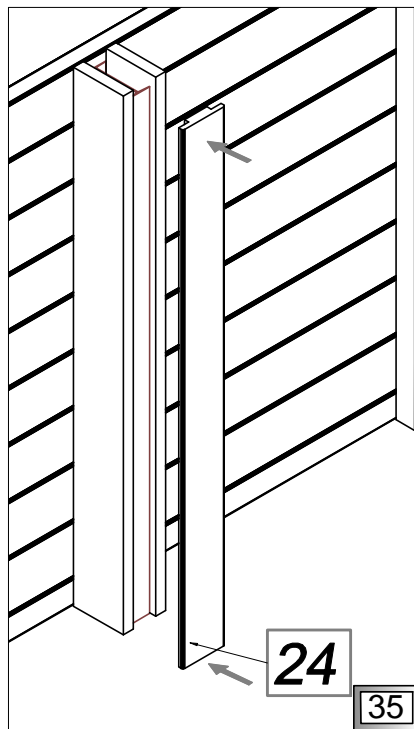

24

35

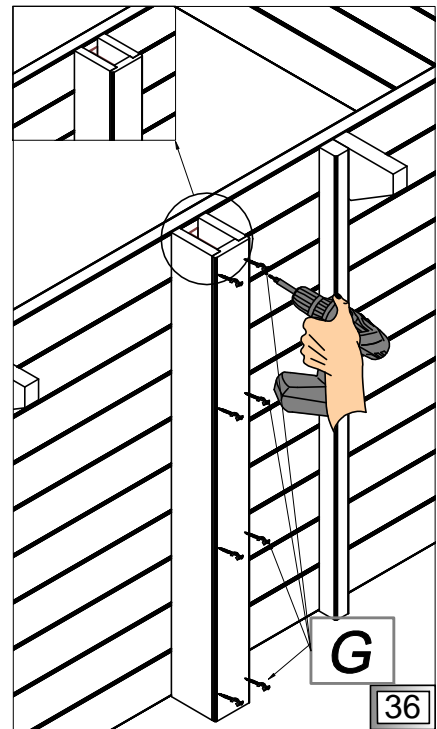

G

36

PL Taras

GB Terrace

D Terrasse

FR Les margelles

IT Terrazza

RU Teppaca



- PL** Montaż desek tarasowych.
- FR** Le montage des margelles.
- GB** Installation of terrace boards.
- IT** Installazione delle tavole da terrazza.
- D** Montage vom Terrassenholz.
- RU** Монтаж досок террасы.

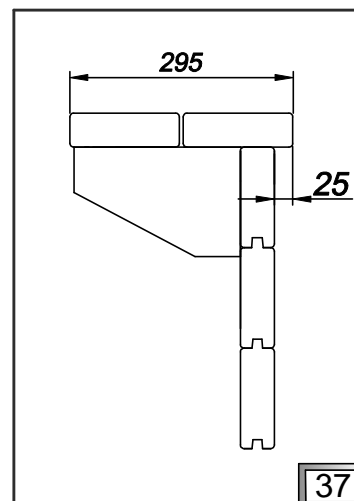
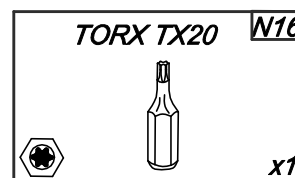
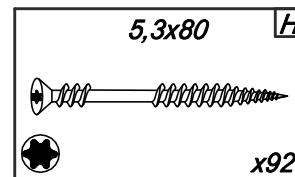
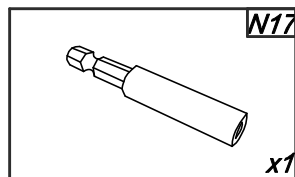
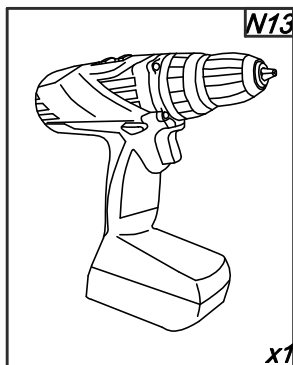
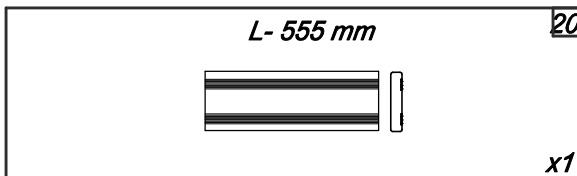
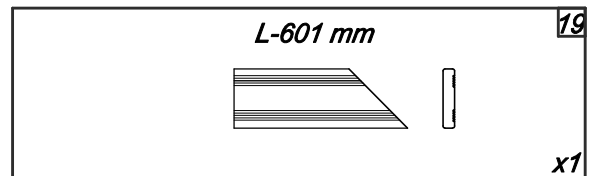
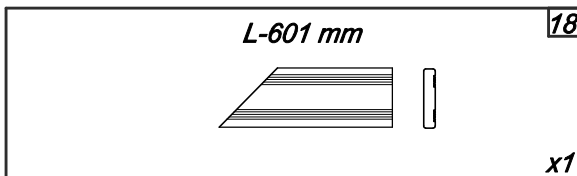
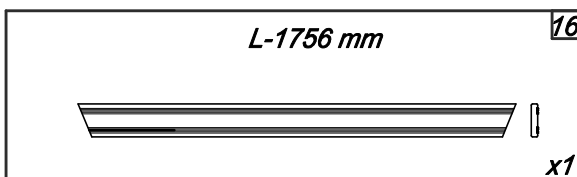
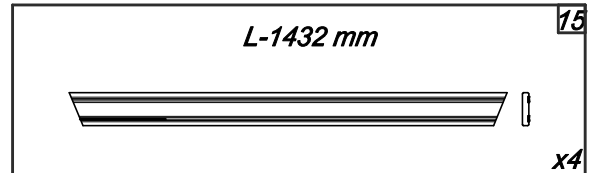
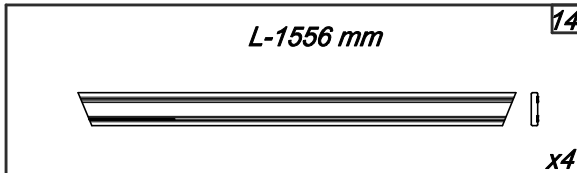
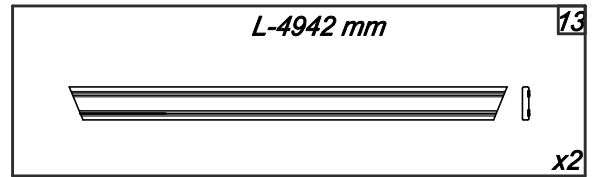
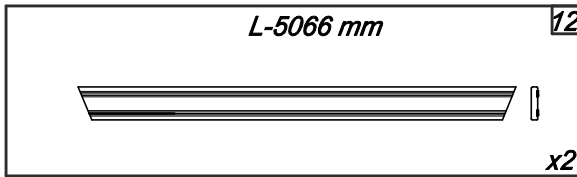

PL Taras

GB Terrace

D Terrasse

FR Les margelles

IT Terrazza

RU Teppaca



PL Zamocuj deski tarsowe wedlug rysunku.

FR Faites monter les margelles suivant le dessin.

GB Mount terrace boards according to the drawing.

IT Montare le tavole da terrazza secondo il disegno.

D Befestigen Sie das Terrassenholz nach der Abbildung.

RU Прикрепить доски террасы согласно рисунку.

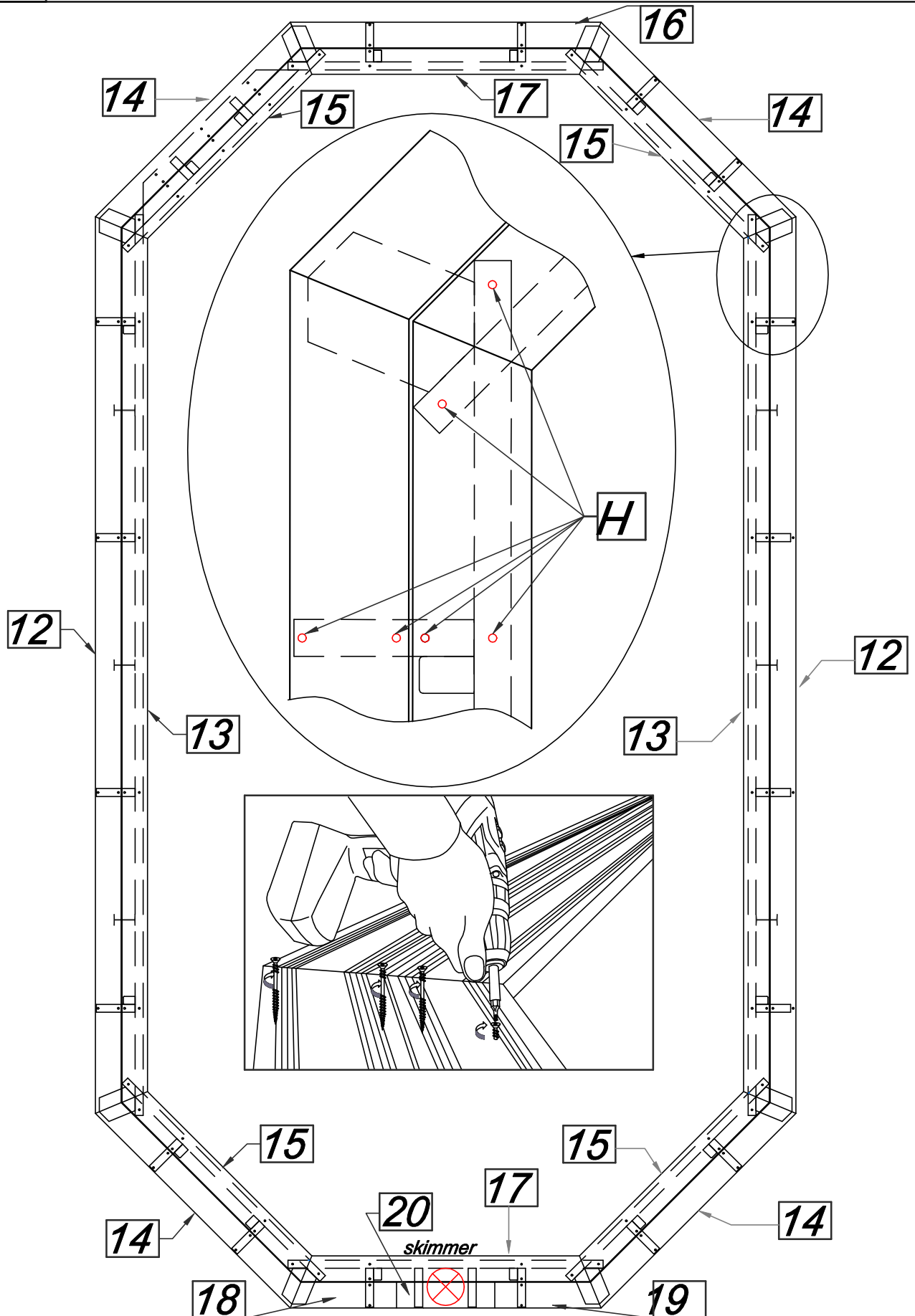

PL Zapięcie tarasu

GB Clip and hook

D Terrassenverschluss

FR Agrafes de margelles

IT Chiusura di terrazza

RU Застежка террасы



- PL** Montaż zapięcia tarasu (A1, A2).
- FR** Le montage des agrafes de margelles (A1, A2).
- GB** Mounting clip and hook (A1, A2).
- IT** Montaggio della chiusura di terrazza (A1, A2).
- D** Montage vom Terrassenverschluss (A1, A2).
- RU** Монтаж застёжки террасы (A1, A2).

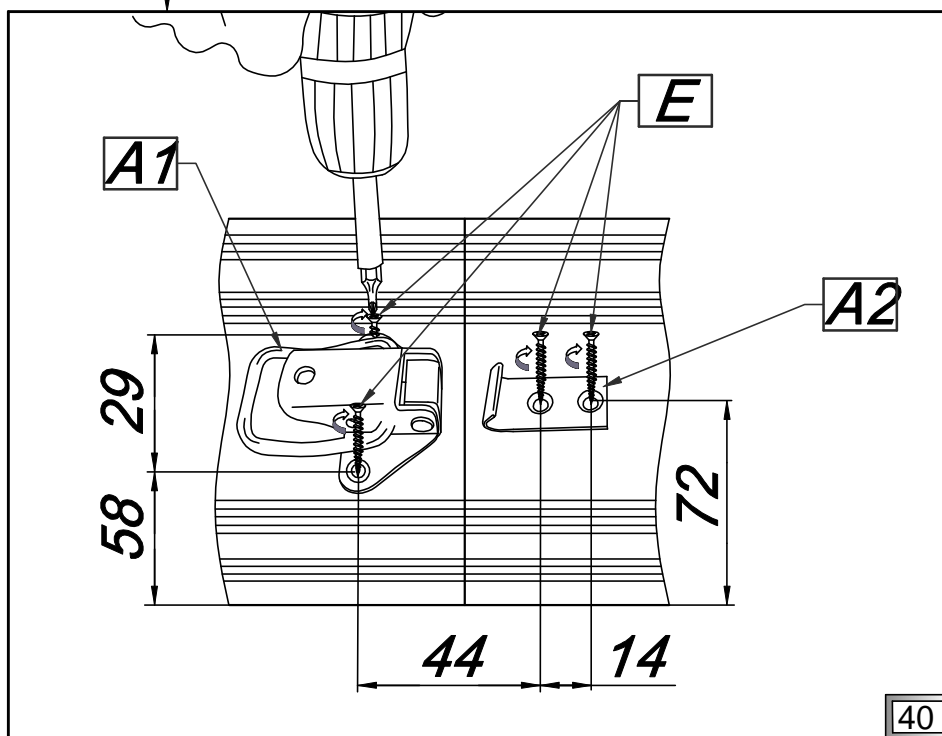
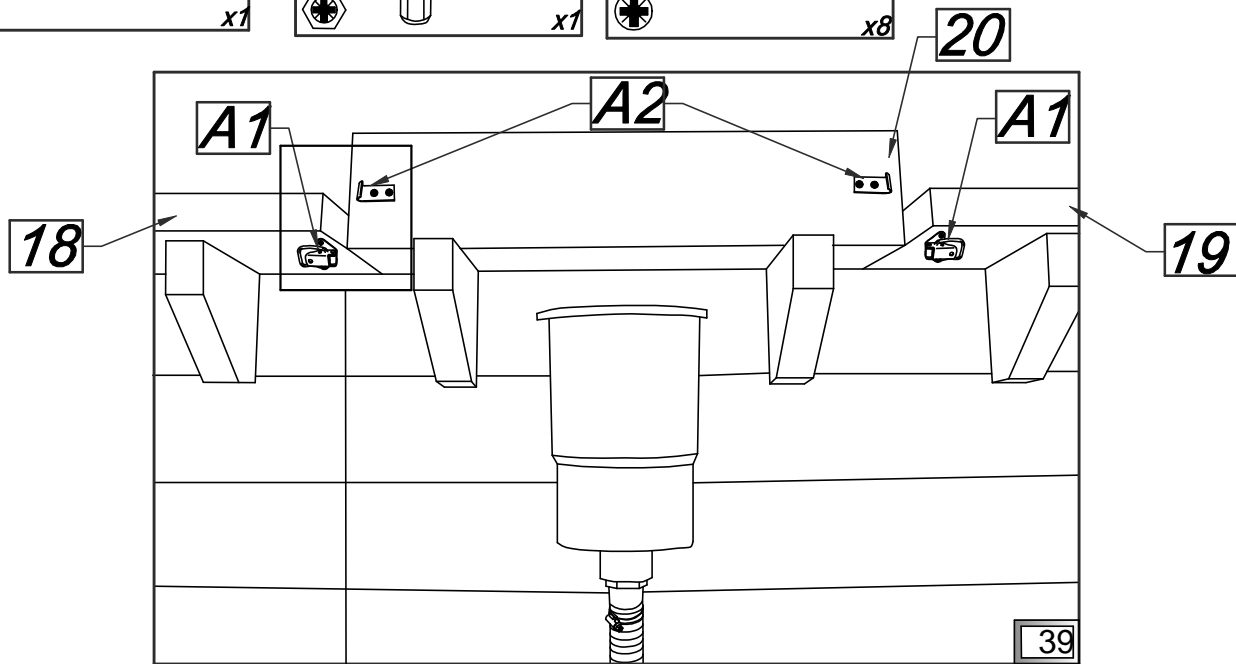
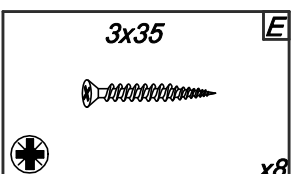
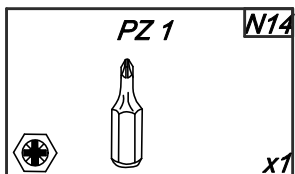
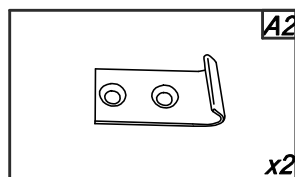
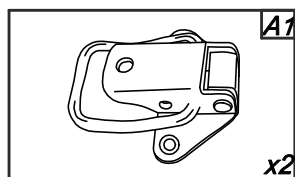
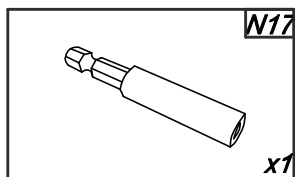
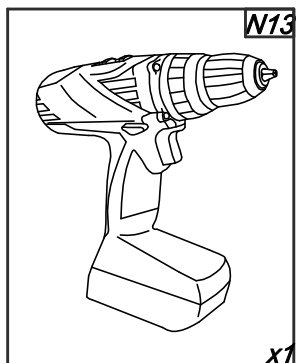

PL Struktura drewniana

GB Wooden structure

D Holzstruktur

FR La structure bois

IT Struttura in legno

RU Деревянная структура



PL Montaż łącznika karo (31) od spodu desek tarasowych.

FR Le montage des jonctions (31) en dessous des margelles.

GB Installation of wooden connector (31) to the bottom of terrace boards.

IT Montaggio di raccordo (31) dal fondo delle tavole da terrazza.

D Montage vom Caro- Bindeglied (31) von der Unterseite des Terrassenholzes.

RU Монтаж соединителя «ромб» (31) снизу досок террасы.

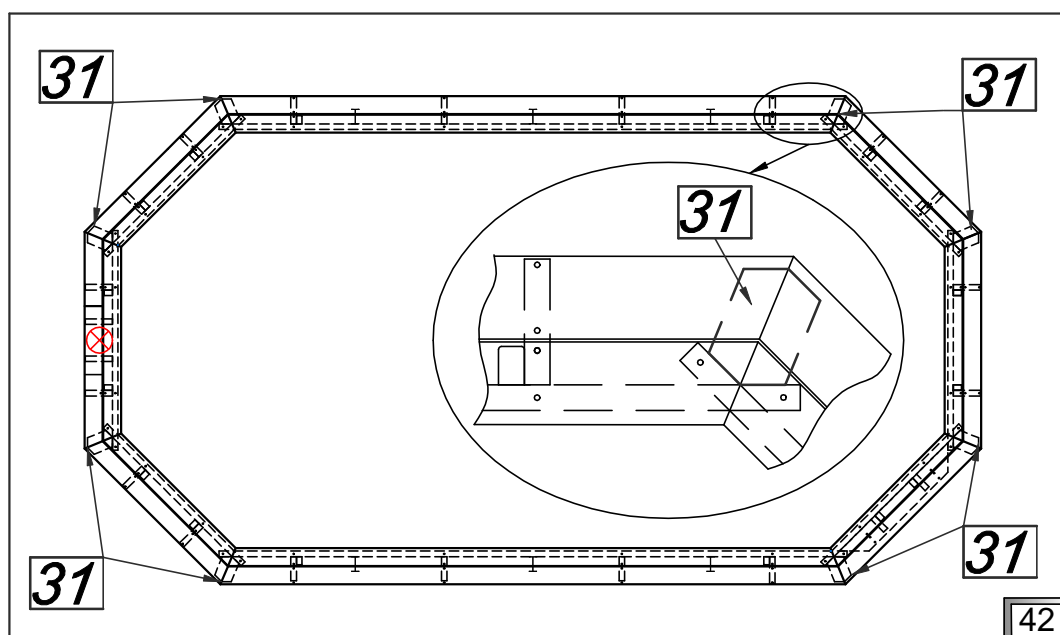
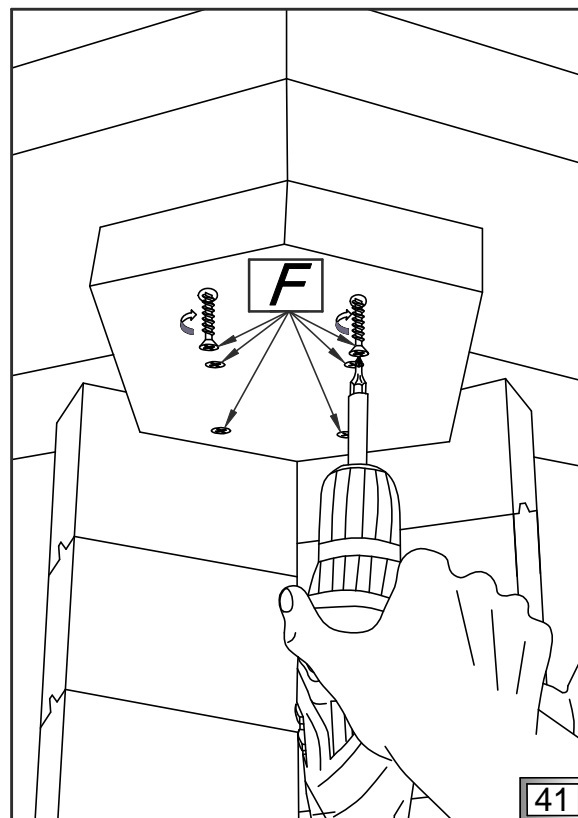
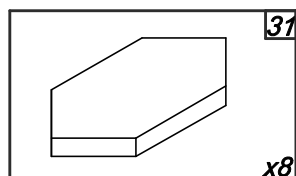
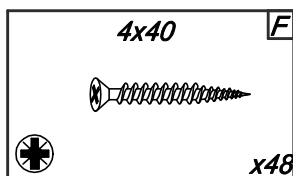
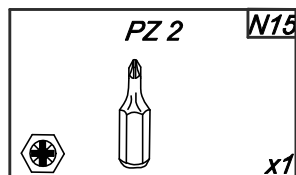
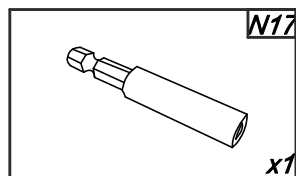
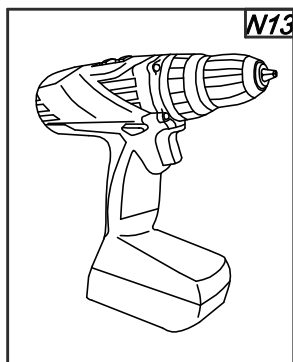

PL Schody drewniane

GB Wooden stairs

D Holztreppe

FR L'escalier bois

IT Scale di legno

RU Деревянная лестница



- PL** Montaż schodów.
- FR** Le montage de l'escalier.
- GB** Installation of stairs.
- IT** Montaggio delle scale.
- D** Montage von Treppen.
- RU** Монтаж лестницы.

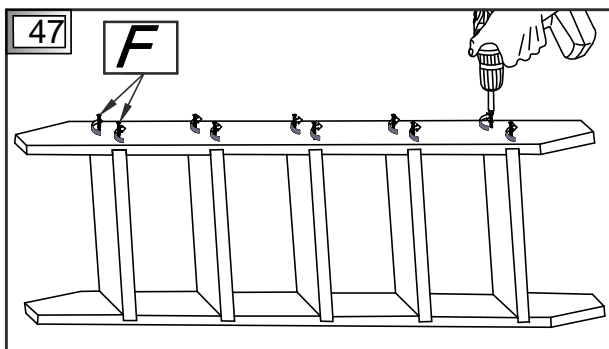
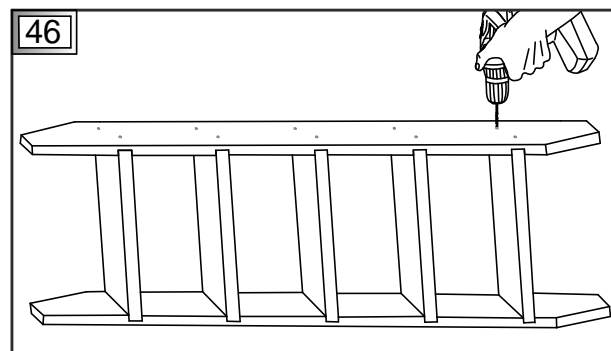
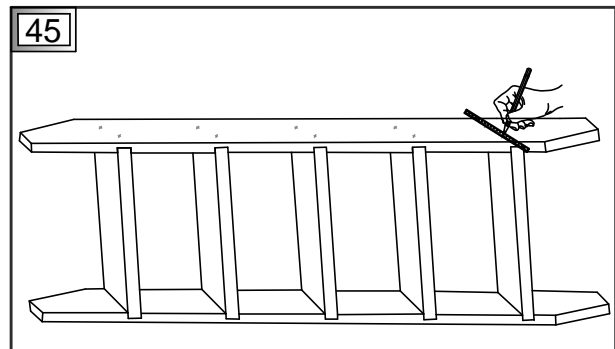
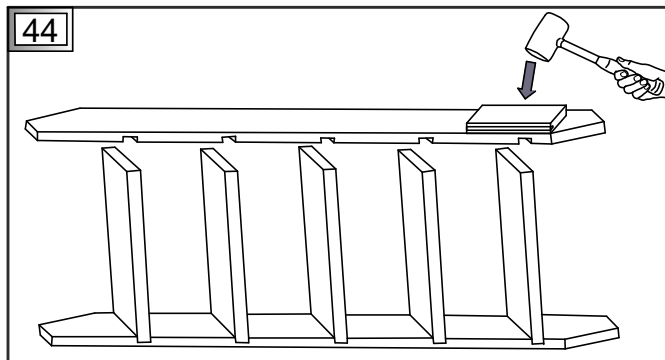
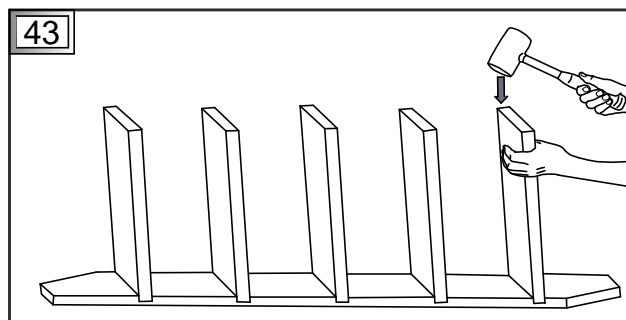
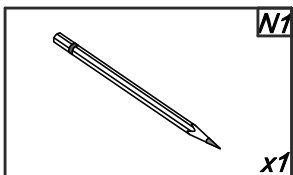
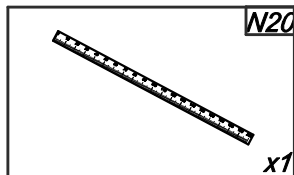
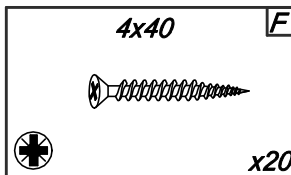
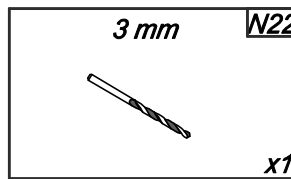
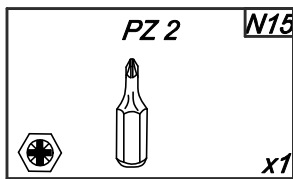
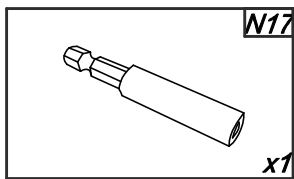
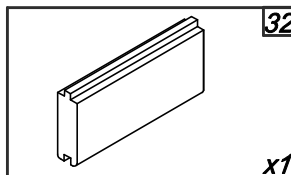
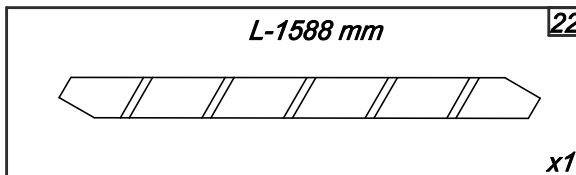
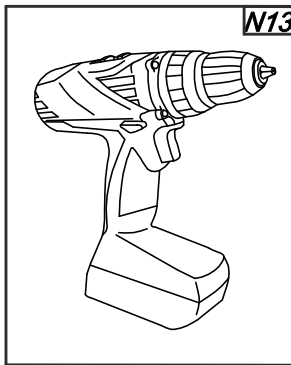
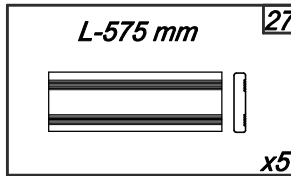
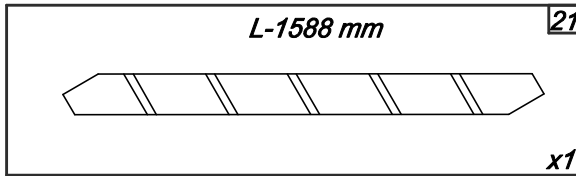
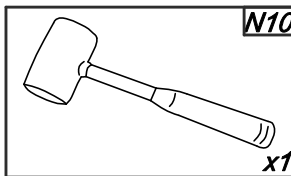

PL Schody drewniane

GB Wooden stairs

D Holztreppe

FR L'escalier bois

IT Scale di legno

RU Деревянная лестница



PL Montaż zawieszki (B1, B2). Schody mocujemy na ścianie ze wspornikiem schodów (29).

FR Le montage des boucles et des gâches (B1, B2). Fixez l'escalier sur la paroi avec le renfort d'escalier (29).

GB Installation of tag and hook kit (B1, B2). Stairs are mounted on the wall with stairs support (29).

IT Montaggio del manico (B1, B2). Le scale sono fissate al muro con uno sbalzo di scale (29).

D Montage vom Gehänge (B1, B2). Die Treppe ist an die Wand mit Treppenstützen (29) zu montieren.

RU Монтаж крючка (B1, B2). Лестница крепится на стене с кронштейном лестницы (29).

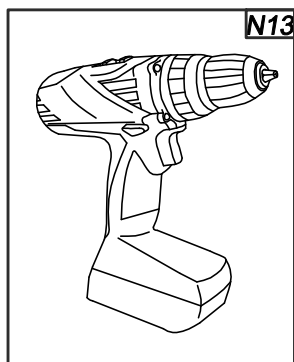

N13

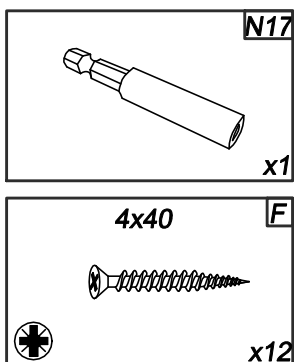

N17

x1

4x40

F

x12

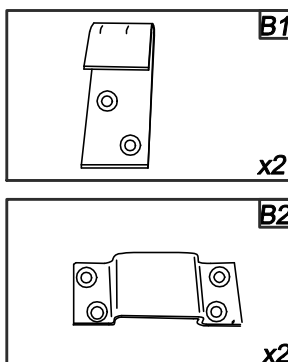

B1

x2

B2

x2

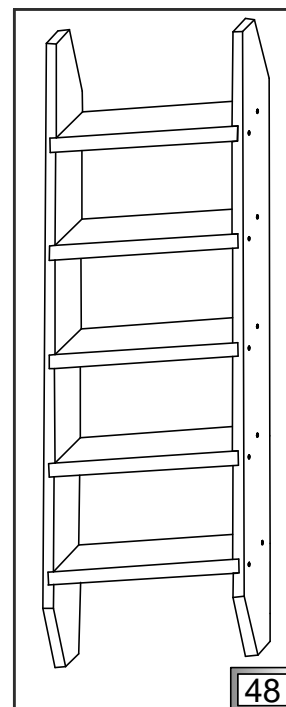

48

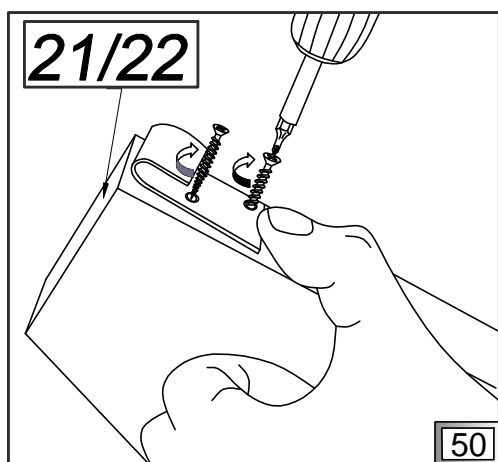

21/22

50

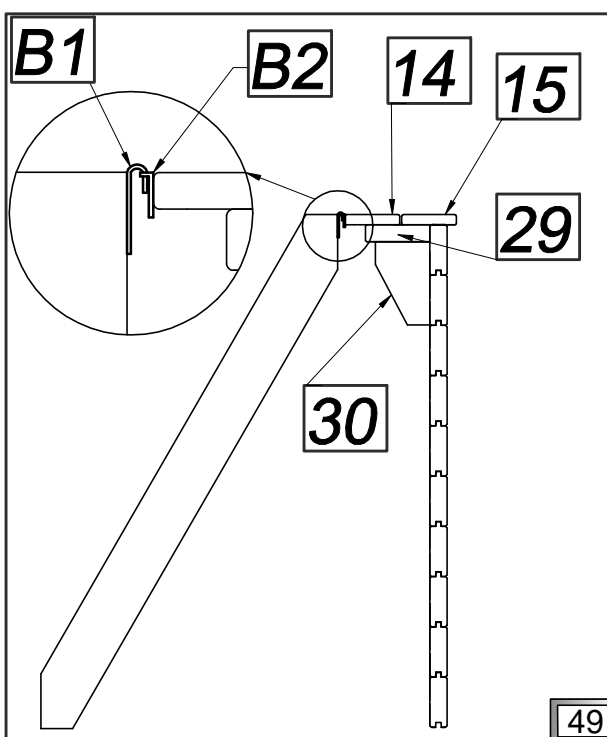

B1

B2

14

15

29

30

49

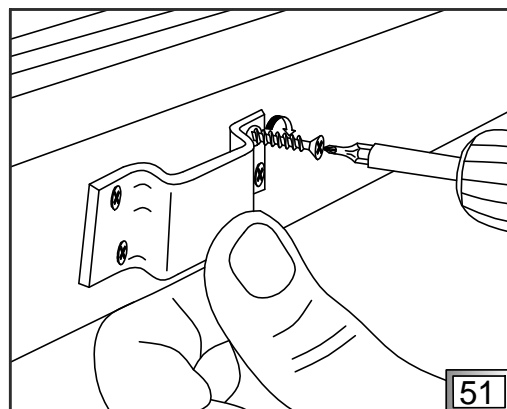

51

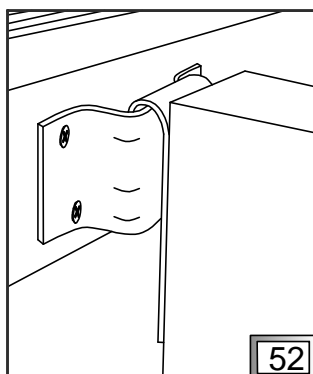

52

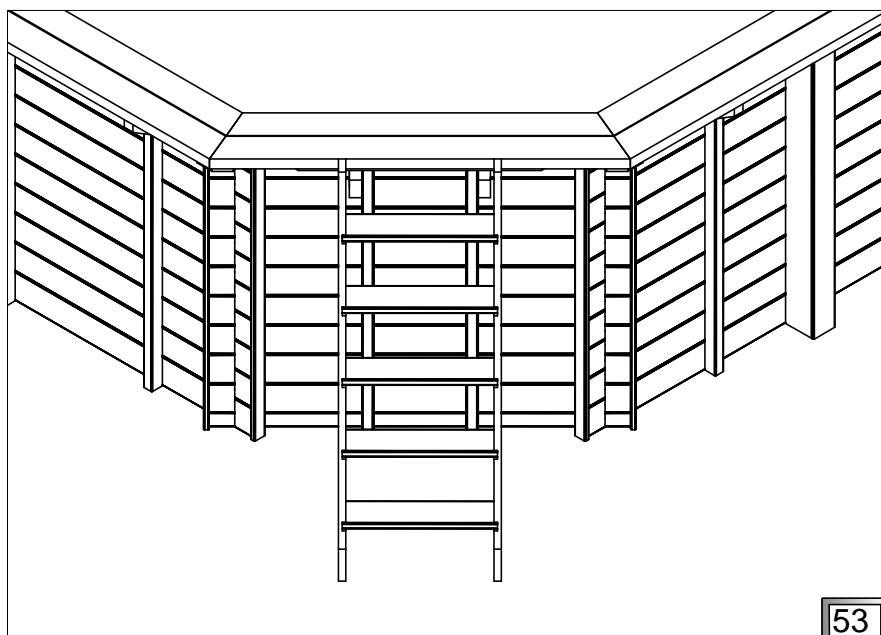

53

(PL) Maskownice

(GB) Corners covers

(D) Abdeckungen

(FR) Les caches

(IT) Mascherini

(RU) Маскировочный



(PL) UWAGA! OPCJA! Montaż maskownic (Y) do desek tarasowych.

(FR) ATTENTION ! OPTION ! Le montage des caches (Y) pour les margelles.

(GB) NOTE! OPTION! Mounting covers (Y) for corners of terrace boards.

(IT) ATTENZIONE! OPZIONE! Montaggio di mascherini (Y) per le tavole da terrazza.

(D) HINWEIS!OPTION! Montage der Abdeckungen (Y) ans Terrassenholz.

(RU) ВНИМАНИЕ! ВАРИАНТ! Монтаж маскировочных экранов (Y) к доскам террасы.

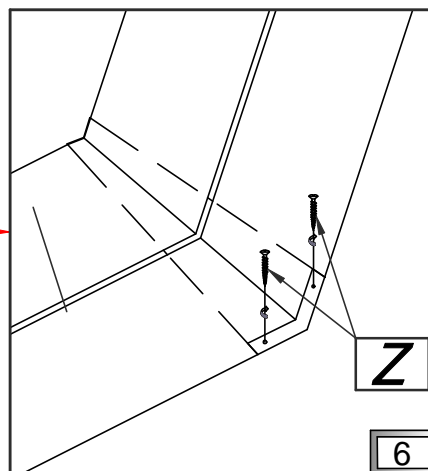
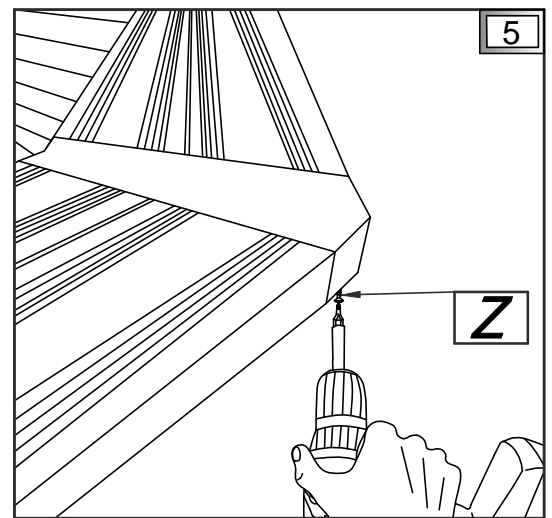
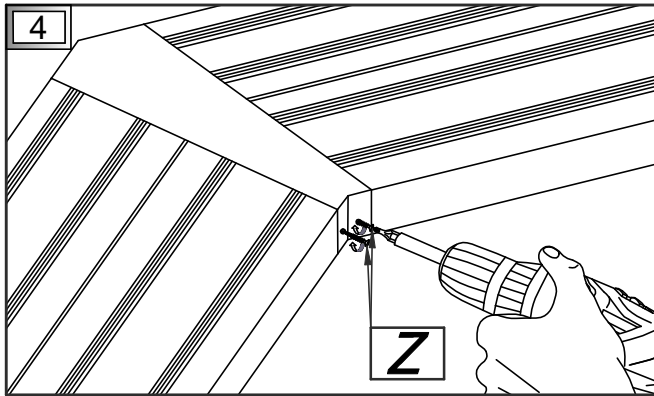
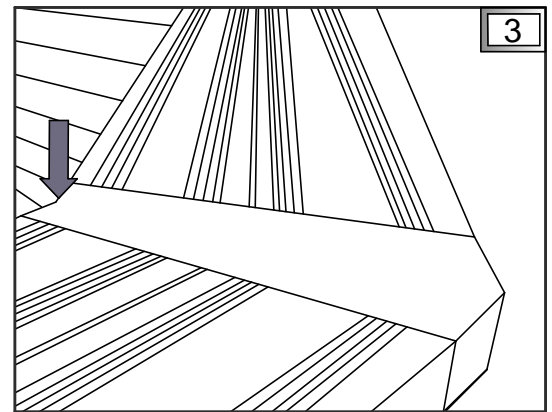
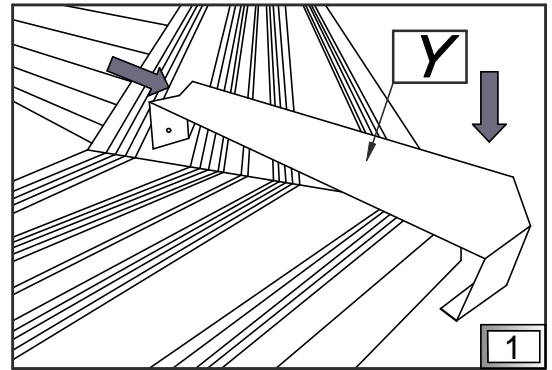
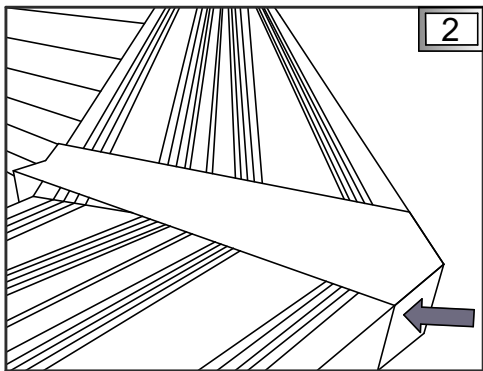
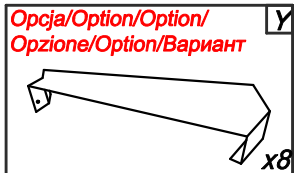
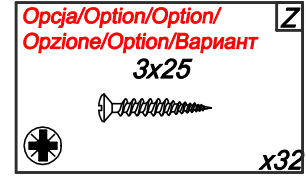
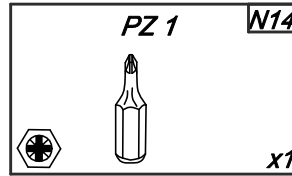
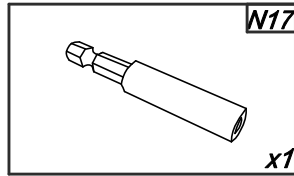
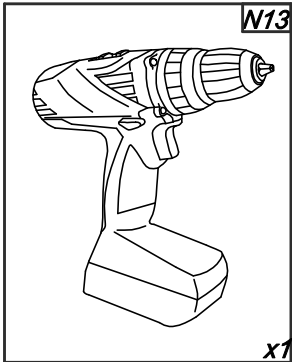

(PL) Widok od spodu tarasu.
(FR) La vue du dessous des margelles.
(GB) View from the bottom of terrace.
(IT) Vista in fondo della terrazza.
(D) Sicht vom unten der Terrasse.
(RU) Вид снизу террасы.