



BSVillage
PISCINE - WELLNESS - OUTDOOR

MANUALE di MONTAGGIO
Piscina in Legno
NaturalWood 700



www.bsvillage.com

Read carefully pool installation manual and user guide before the installation!



BEFORE INSTALLATION

This manual presents the correct assembly procedure for the swimming pool, step by step. We have undertaken all possible efforts to make sure that the materials are as close to the actual items and present their layout as closely as possible. Please remember, however, that all figures are indicative only and individual elements delivered in your set may be different than their graphical visualizations presented in the manual.

Follow the rules of safe use of the pool!

Before the installation, store the kit in a dry place which provides adequate air flow. Protect from the weather (sunlight, precipitation). Do not store under cover in direct sunlight. Store up carefully the unpacked wooden elements without exposure to direct sunlight and water.

Installation should be finished within 3 days from opening the package.



To protect wood from weather, it is advisable to apply preparations intended for the protection of external wooden constructions (e.g. oil scumble which is available in the current offer - product developed for the effective protection of wooden swimming pools). Pool preservation should be performed at least once a year, and for pools subject to extreme weather conditions even more often.

Lack of once a year conservation of the structure causes loss of warranty!



Before installation check quantity of elements and if they are not faulty. Missing elements or any damages should be reported before the installation. It is possible that some elements of equipment in the assembly instruction will not correspond exactly to those supplied.



Prepare essential tools indicated in the manual – tools are not included in the pool kit.



RUBBER PLUG

In order to prepare pool for the winter season (especially if there is a risk of freezing water) use a plug dedicated to shut the access of water to filtration system. Inlet must remain in the pool. Fix a plug under water. Remember to disconnect filtration set from source of water and dry the inlet (the part of inlet which is outside the pool). For winter season, it is recommended to get rid of water remaining in pump and sand filter, otherwise freezing water can cause devastation of whole set.



GROUND PREPARATION

Partly or fully in-ground pool must be secured in accordance with documentation enclosed in pool manual. Please see the drawing in the manual.

Wooden structure protection required:

- 1 – FOUNDATION**
- 2 – DRAINAGE PIPE**
- 3 – FOUNDATION BUBBLE WRAP**
- 4 – GRAVEL**
- 5 – GEOTEXTILE**
- 6 – GROUND**

In order to define the area for the pool, place the first layer, then remove it to prepare the area.

When preparing the area for the pool, remove grass, roots and stones.

The ground on which the pool is situated should be stable, solid, flat and, above all, levelled on the entire surface.

For the pool models without steel supports apply sand stabilized with cement or concrete screed.

For the pool models with steel supports, concrete base must be prepared in accordance with the diagram presented in the manual.

Manual guidelines for the arrangement of 2T posts and preparation of reinforced concrete screed must be strictly followed. All dimensions must comply with the manual guidelines.

We recommend that concrete floor is laid by specialized companies!



WOODEN STRUCTURE ASSEMBLY

The assembly of the structure starts with the first layer.

After arranging each layer, check the diagonals according to the drawing in the instruction.

To ensure that connections of tongues and grooves in construction planks are precise and tongues are not damaged, it is necessary to use a wooden knocking block. Hitting directly against the elements of the tongue or groove is unacceptable. Damages arising from this preclude the proper folding of the elements or reduce their durability.

Continue to assemble of all wooden elements in the order shown in the instructions.

OPTION → If your pool has a lighting option, install the lamp in the pool structure in accordance with the additional instructions attached to the lamp.



SKIMMER ASSEMBLY

Assemble all elements of a complete skimmer, and secure the threads with Teflon tape.

Note!

The moment of placing the skimmer in the wooden structure depends on the skimmer model. Perform this step according to the instructions in your pool's manual.

Skimmer should be screwed in the wooden structure in the indicated in manual time of installation and in indicated places. Cover the diffuser surfaces with double-sided tape and stick the gasket.



PREPARATION OF THE INNER SIDE OF THE POOL

Distribution of geotextile starts from the inner side of pool walls, for installation use double-sided tape or glue. Prepare holes for the skimmer and nozzles.

PVC profiles for liner installation cut to the indicated dimensions. Pay attention to the required angles. According to the diagram prepare the holes \varnothing 2 mm. Mount the profiles to the structure by connecting them along the entire pool. Plan profiles distribution to make as few joints as possible.

Spread the geotextile evenly over the pool floor, then start installing the liner (pool foil) in PVC profiles.

It is recommended to store the liner in its original packaging in a dry room at a moderate ambient temperature (15-25 degrees Celsius). Warm temperature makes liner material more manageable.

When installing the liner into the pool structure, make sure that joints and welds are perfectly distributed in the corners of the walls. Smooth all the folds. Pay attention to the places on the holes for lamp, nozzle, skimmer.

Install the liner in PVC profiles using liner lock.

When pouring water, straighten the liner on the ground with bare feet, level out any unevenness that may occur, at the same time stretch the liner walls down to the ground (pay great attention to the corners).

Pool water should be poured gradually, as indicated in manual.



FILTRATION SYSTEM

Stop the water level 5-10 cm before reaching the nozzle location and cut the hole for the nozzle according to the drawing in manual.

For the nozzle installation coat the liner facing side of the gasket with Vaseline, secure the thread of hose connector with Teflon tape and connect the hose to the nozzle, tighten with the hose clip. Adjust the hose clip gently, not to break the clamp. Watch for any leakage. If there is a leakage, apply more tape and tighten the clamp.

Fill half of the filter tank with water. Second half fill with the sand you can find in the pool kit.

Assembly the filtration set: valve, flange clamp, pressure gauge. Cover thread of hose connectors with Teflon tape. Connect elements of filtration system according to the guidelines shown in manual of your pool model. After completing this step, keep pouring water.



SKIMMER INSTALLATION

Stop pouring water when the water level is 5-10 cm below the skimmer, to cut a hole in the place of skimmer.

Please make sure to prepare a hole in the geotextile material before.

Fit the skimmer frame and thread it gently into the skimmer through the liner, for easier location of the skimmer placement. Do not cut the liner before the frame is screwed, the cut may shift and the hole may not fit the frame when it's screwed on.

Cut the hole, then remove the frame and install all skimmer elements in their place according to the drawing from the manual.

Make sure you connect all filter elements with hoses according to the instructions and continue filling with water. To ensure proper work of the filter set, top up the water level in the pool, to the half of the skimmer!



INSTALLATION OF THE TERRACE BOARDS

Place the pool decking boards according to the diagram presented in the manual.

To assemble the movable board (for easy access to the skimmer), use the hinges included in the set.



Wooden corner connectors attach to the bottom of the terrace boards.

It is advisable to install the terrace planks after the pool is filled with water. For aesthetic reasons, it is recommended to remove and re-lay the terrace planks within 1–2 weeks from filling up the pool.

Pay attention to the even distribution of the terrace screws.

After completing the installation of the terrace boards, proceed with the installation of the external stairs and internal ladder.

OPTION → If your pool has corner covers as an option perform the installation as in manual.



Leggere le istruzioni e il manuale d'uso prima dell'installazione!



PRIMA DEL MONTAGGIO

Le istruzioni in Suo possesso mostrano passo dopo passo come installare correttamente la piscina. Abbiamo fatto ogni sforzo per preparare materiali che riflettano il più possibile lo stato e l'aspetto reale dei vari elementi. Tuttavia, si prega di notare che tutti i disegni sono solo a scopo illustrativo ed è possibile che i singoli elementi forniti nel Suo set possano in effetti differire nell'aspetto dalla loro visualizzazione grafica contenuta nelle istruzioni.

Si attenga alle regole per un uso sicuro della piscina!

Prima dell'installazione, conservare il pacchetto in un luogo asciutto con un adeguato flusso d'aria e proteggerlo dagli agenti atmosferici nocivi (luce solare, precipitazioni). Non conservare sotto copertura in un luogo esposto alla luce diretta del sole. Conservare con cura i componenti in legno non imballati, senza esporli alla luce diretta del sole o all'acqua.

Eeguire il montaggio entro 3 giorni dal disimballaggio della struttura.



Per proteggere il legno dai fattori atmosferici, si consiglia di rifinire la superficie in legno della piscina con preparati destinati alla protezione delle strutture esterne realizzate con questo materiale (per esempio, la vernice ad olio disponibile nella nostra offerta attuale - prodotto appositamente progettato per una protezione efficace delle piscine in legno). La manutenzione della piscina deve essere effettuata almeno una volta all'anno, e nel caso delle piscine esposte a condizioni climatiche estreme anche più spesso.

La mancata manutenzione annuale della struttura comporterà l'annullamento della garanzia!



Prima dell'installazione, controllare attentamente il numero di componenti e l'assenza di danneggiamenti. I singoli raccordi indicati nelle istruzioni possono differire leggermente da quelli effettivamente forniti. Qualsiasi difetto o danno deve essere segnalato prima dell'installazione.



Preparare gli strumenti necessari indicati nelle istruzioni - gli strumenti non sono inclusi nel kit.



TAPPO DELL'UGELLO

Per preparare la piscina alla stagione invernale (soprattutto se c'è il rischio di congelamento dell'acqua), utilizzare un tappo per gli ugelli di afflusso al fine di interrompere l'alimentazione dell'acqua verso il gruppo filtrante. Lasciare l'ugello nella piscina, montare il tappo sott'acqua. Ricordarsi anche di scollegare il gruppo filtrante dalla fonte d'acqua e di asciugare bene l'ugello dall'esterno. Si consiglia anche di rimuovere l'acqua residua dalla pompa e dal filtro a sabbia annesso durante il periodo invernale (località a rischio di gelo). In caso contrario, l'acqua gelata può distruggere l'intero set.



PREPARAZIONE DEL SUBSTRATO

La struttura di una piscina interamente o parzialmente interrata deve essere protetta secondo le indicazioni riportate nelle istruzioni.

È necessaria una protezione secondo il disegno presente nelle istruzioni:

- 1 - FONDAZIONE DELLA PISCINA**
- 2 - TUBO DI DRENAGGIO**
- 3 - MEMBRANA A BOLLE PER FONDAZIONI**
- 4 - GHIAIA**
- 5 - GEOTESSILE**
- 6 - TERRENO**

Per delimitare l'area per la piscina, stendere un primo strato, destinato alla successiva rimozione, per preparare il terreno.

Durante le operazioni di delimitazione dell'area per la piscina, rimuovere l'erba, le radici e le pietre.

Il substrato per la piscina deve essere solido, piatto e livellato!

Nel caso di piscine senza supporti in acciaio - utilizzare sabbia stabilizzata con cemento (strato - 2 cm) o massetto di cemento.

Nel caso di una piscina con supporti in acciaio - la base dello scavo / massetto in cemento deve essere preparata secondo lo schema riportato nelle istruzioni.

Le linee guida per il posizionamento dei montanti 2T e la preparazione dell'armatura per il massetto devono essere rigorosamente rispettate. Tutte le dimensioni devono essere in accordo con le linee guida presenti nel manuale.

Raccomandiamo che il massetto di cemento sia eseguito da aziende specializzate.



INSTALLAZIONE DELLA STRUTTURA IN LEGNO

Iniziare l'installazione della struttura con il primo strato.

Controllare le diagonali dopo la posa di ogni strato. Le dimensioni dovranno corrispondere a quelle indicate nelle istruzioni.

Quando si installano gli strati successivi, utilizzare il martelletto fornito con gli elementi in legno della struttura. Non è consentito l'impatto diretto sui componenti destinati a formare il collegamento a incastro. Il danno risultante rende impossibile l'assemblaggio dei componenti o ne indebolisce la forza.

Continuare ad assemblare i vari elementi in legno nell'ordine indicato nelle istruzioni.

OPZIONE → Se la Sua piscina ha un'opzione di illuminazione, installare la lampada nella struttura della piscina secondo le istruzioni aggiuntive fornite con la lampada.



PREPARAZIONE DELLO SKIMMER

Assemblare i singoli componenti che formano lo skimmer completo, mettendo in sicurezza le filettature con nastro di teflon.

Attenzione!

Il tempo di installazione dello skimmer nella struttura in legno dipende dal modello dello skimmer. Eseguire questo passo secondo le linee guida riportate nelle istruzioni della tua piscina.

Lo skimmer deve essere avvitato nella fase appropriata e nei punti indicati.

Durante l'installazione, le superfici del diffusore devono essere coperte con nastro biadesivo e la guarnizione deve essere incollata in posizione.



PREPARAZIONE DELL'INTERNO DELLA PISCINA

Installare il geotessile usando nastro biadesivo o colla. Iniziare con le pareti interne della piscina. Preparare i fori per lo skimmer e gli ugelli nel geotessile uniformemente distribuito.

Tagliare i profili per il fissaggio della membrana per la piscina alle dimensioni indicate, assicurandosi di mantenere gli angoli richiesti. Eseguire dei fori da \varnothing 2 mm nei profili come mostrato. Successivamente, montare i profili sulla struttura, unendoli intorno al perimetro della piscina. Ricordare che i profili sono uniti nel senso della lunghezza. Pertanto, la loro distribuzione deve prevedere il minor numero di giunzioni possibile.

Stendere il geotessile in modo uniforme sulla base della piscina e iniziare l'installazione del liner (membrana per la piscina) nei profili in PVC.

Conservare la membrana per la piscina imballata in un luogo asciutto, a una temperatura ambiente di 15-25 gradi, prima dell'installazione. La temperatura calda renderà il materiale più facile da montare e installare nella struttura

Adattare con cura gli angoli della membrana per piscine agli angoli della piscina. Spianare tutte le pieghe. Fare attenzione alle aree intorno ai fori per la lampada, l'ugello, lo skimmer.

Installare la membrana della piscina nei profili in PVC premendo con la guarnizione (tappo).

Mentre si versa l'acqua, stendere la membrana (liner) sul terreno con i piedi nudi, appianare le irregolarità, tendendo contemporaneamente le pareti al suolo (prestare particolare attenzione agli angoli).

L'acqua della piscina deve essere introdotta gradualmente come indicato nelle istruzioni.



SISTEMA DI FILTRAGGIO

Fermare il riempimento dell'acqua 5-10 cm prima della posizione destinata all'ugello e tagliare il foro per l'ugello come indicato nelle istruzioni.

Lubrificare le guarnizioni sul lato del liner con vaselina, attaccare gli ugelli, coprire le filettature degli ugelli con nastro di teflon. Successivamente, attaccare il tubo all'ugello e fissarlo con fascette a vite. Regolare la pressione facendo attenzione a non rompere la fascetta, osservare che non vi siano perdite. Se non c'è tenuta, applicare altro nastro e stringere la fascetta.

Riempire il serbatoio del filtro fino a metà con acqua. Riempire l'altra metà del serbatoio del filtro con la sabbia inclusa nel kit.

Montare il gruppo filtrante composto da valvola, morsetto e manometro. Coprire i raccordi dei tubi con del nastro di teflon, sia sulla filettatura che sul raccordo del tubo.

Collegare i componenti del sistema di filtraggio secondo le istruzioni del modello acquistato.

Continuare a riempire con acqua dopo questa fase



INSTALLAZIONE DELLO SKIMMER

Smettere di versare l'acqua quando il suo livello raggiungerà 5-10 cm al di sotto del luogo designato per lo skimmer, al fine di realizzare un buco nella membrana per questo dispositivo. Ricordarsi di realizzare anticipatamente i fori nel geotessile sotto alla membrana della piscina.

Montare il telaio dello skimmer all'interno e avvitare delicatamente alla parte esterna dello skimmer attraverso il liner per rendere più facile segnare la posizione del taglio. Non tagliare il liner prima di avvitare il telaio Il taglio, infatti, potrebbe spostarsi e il foro fatto potrebbe non adattarsi dopo l'avvitamento del telaio.

Tagliare il foro, poi rimuovere il telaio, installando gli altri elementi dello skimmer al suo posto. Guarnizione, telaio e maschera. Attenersi all'illustrazione presente nelle istruzioni.

Assicurarsi di aver collegato tutti gli elementi di filtraggio con i tubi secondo le istruzioni e continuare a riempire d'acqua.

Per garantire il corretto funzionamento del gruppo filtrante, integrare il livello dell'acqua della piscina fino a metà dello skimmer!



INSTALLAZIONE DELLE TAVOLE DI DECKING

Posare le tavole di decking della piscina secondo lo schema riportato nelle istruzioni.

Usare le cerniere incluse per montare la tavola mobile di accesso allo skimmer.



Installare i connettori angolari sul lato inferiore delle tavole di decking.

Per migliorare l'estetica, si raccomanda di rimuovere e riposizionare le tavole di decking entro 1-2 settimane dal riempimento della piscina.

Assicurarsi che le viti per il decking siano uniformemente distanziate.

Una volta che le tavole di decking saranno state posate, procedere con l'installazione delle scale esterne e della scaletta interna.

OPZIONE → Se la Sua piscina ha l'opzione delle maschere angolari, eseguite la loro installazione come indicato nelle istruzioni.

(PL) Instrukcja montażu

(GB) Assembly instructions

(DE) Montageanleitung

(FR) Notice de montage

(IT) Istruzioni di montaggio

(NL) Montage-instructies

OALL 698

UWAGA /REMARQUE/ /NOTE/ ATATTENZIONE /HINWEIS /LETOP

(PL) Maksymalna wysokość słupa wody ~ 1.2 m

(FR) Niveau maximum de la colonne d'eau ~ 1.2 m

(GB) The maximum water column level ~ 1.2 m

(IT) Livello massimo della colonna d'acqua ~ 1.2 m

(DE) Maximaler Wasserstand ~ 1.2 m

(NL) Maximum niveau waterkolom ~ 1.2 m

Objętość wody w basenie 27.82 m³

Le volume de l'eau dans la piscine 27.82 m³

Water capacity in the pool 27.82 m³

Il volume di acqua in piscina 27.82 m³

Volumen von Wasser im Schwimmbecken 27.82 m³

Water inhoud van het zwembad 27.82 m³

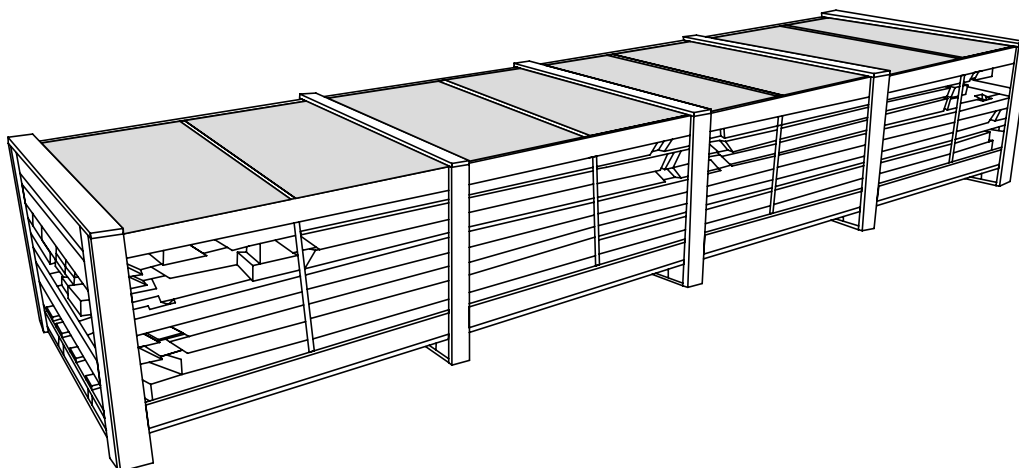
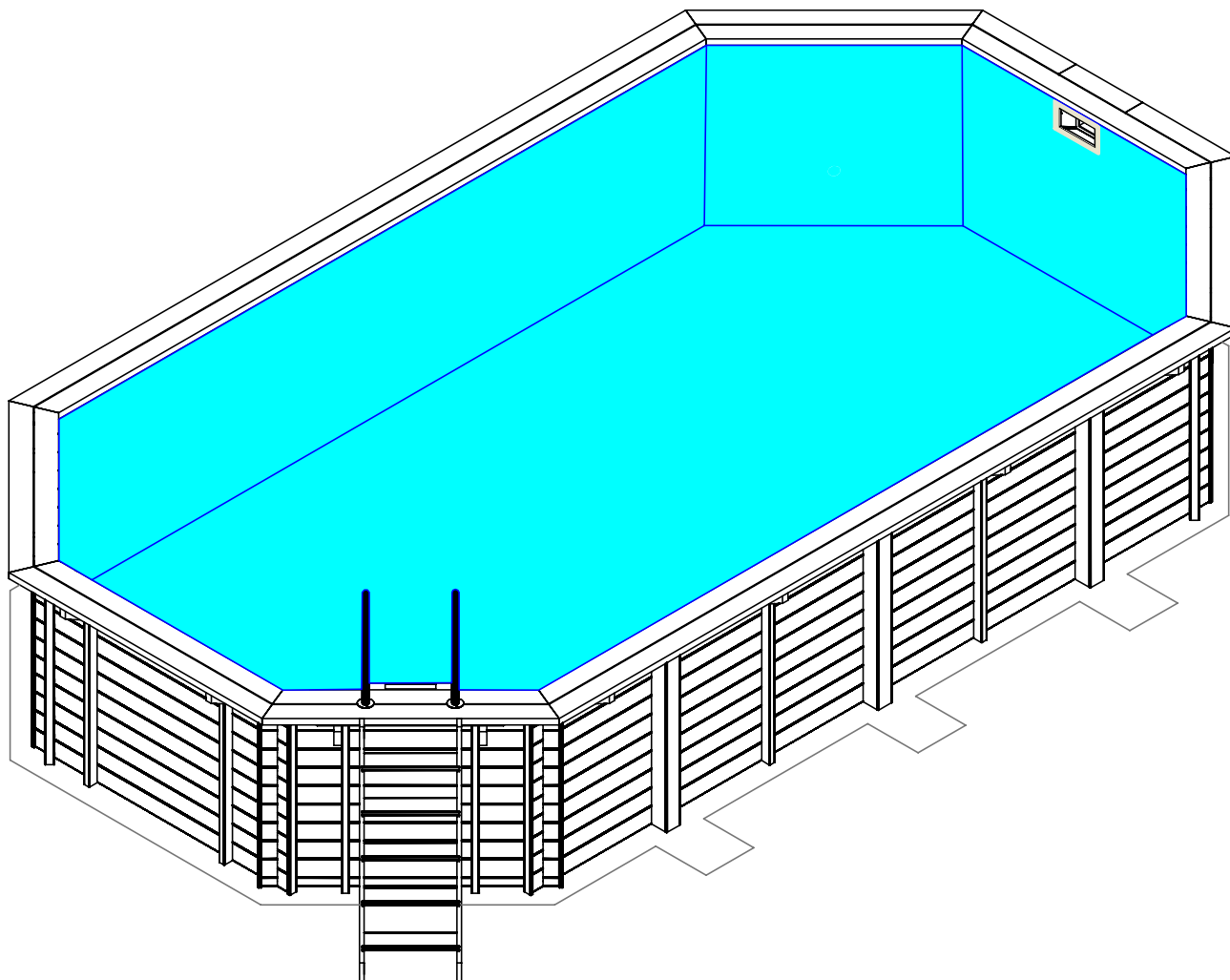

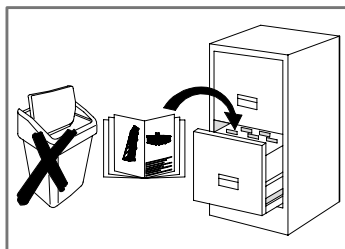
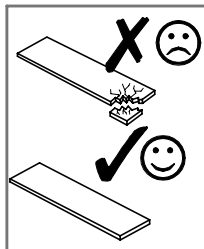
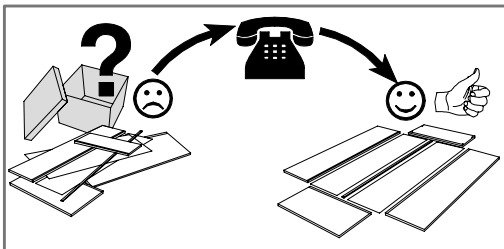
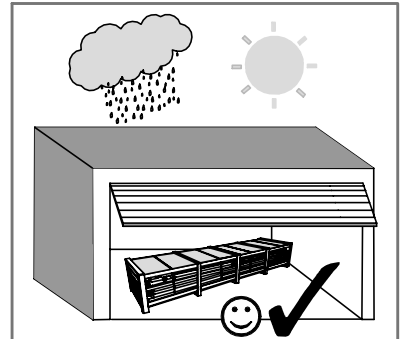
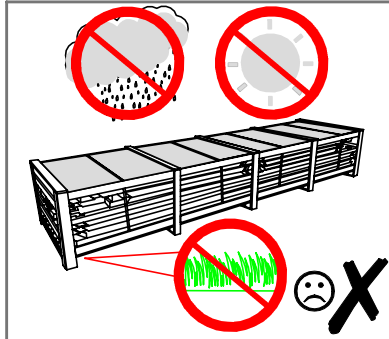
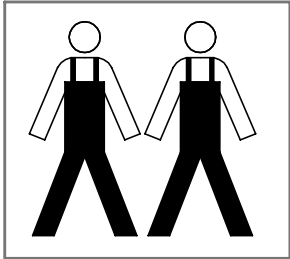
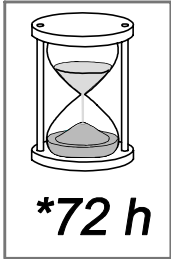

REGULAR MAINTENANCE



OIL

VERY IMPORTANT!

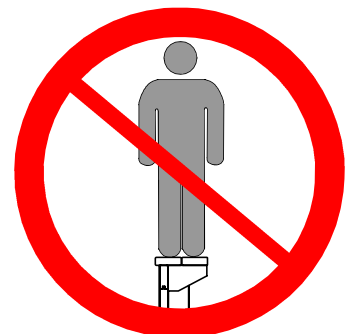

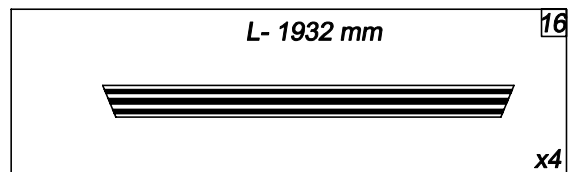
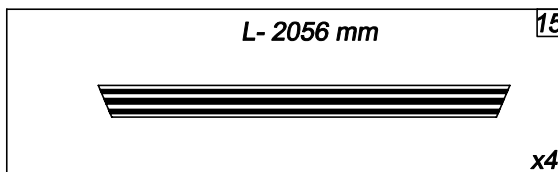
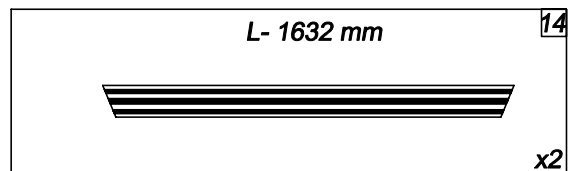
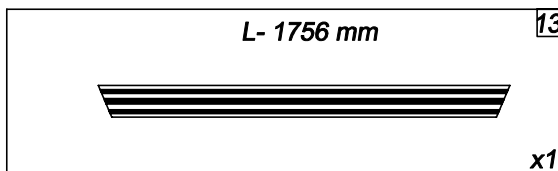
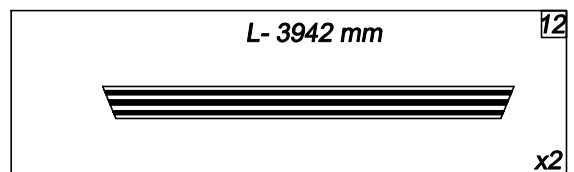
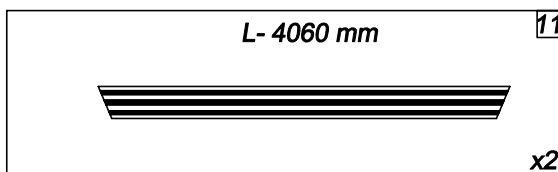
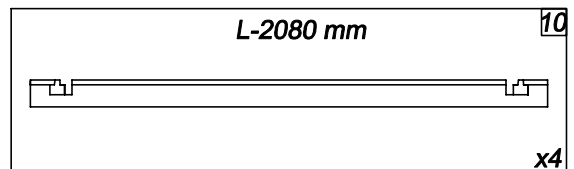
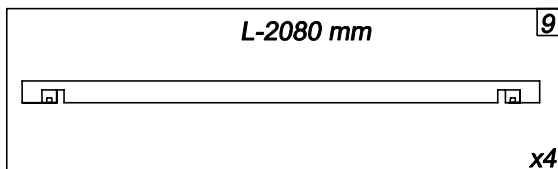
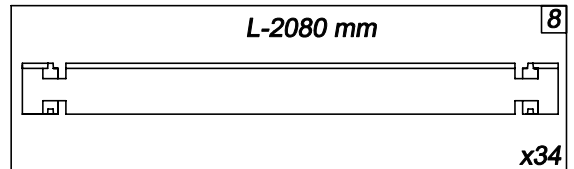
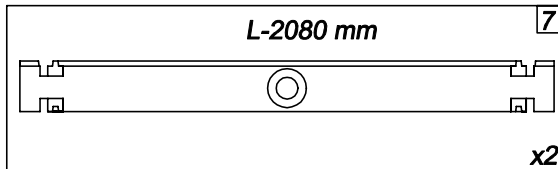
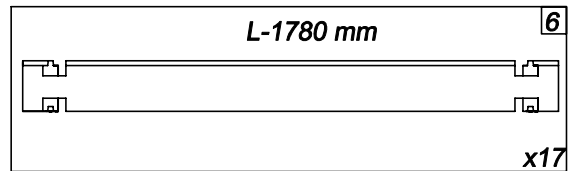
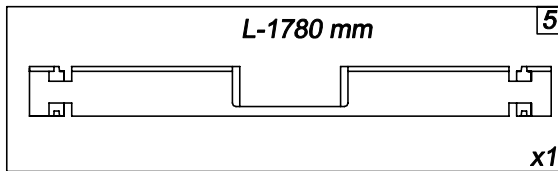
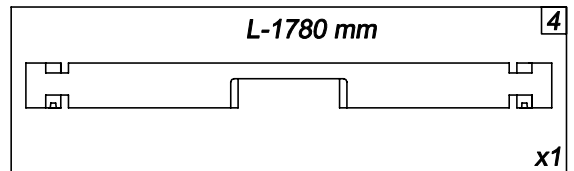
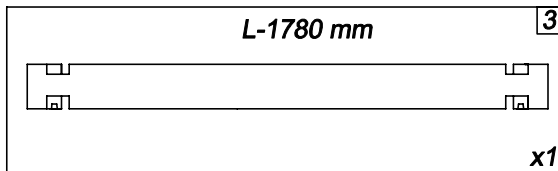
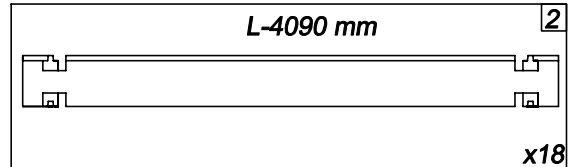
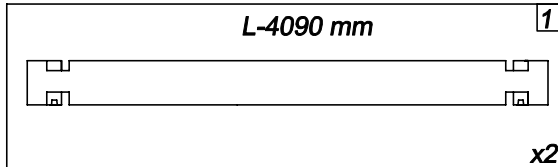
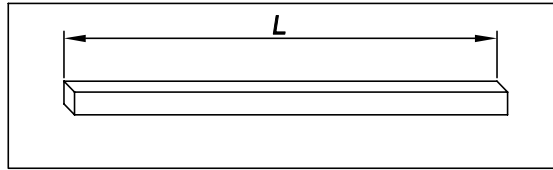

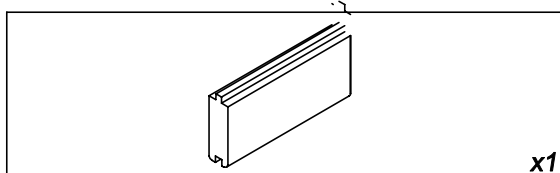
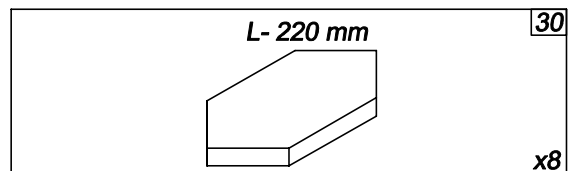
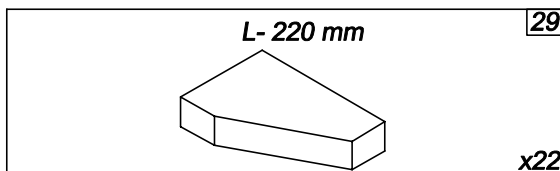
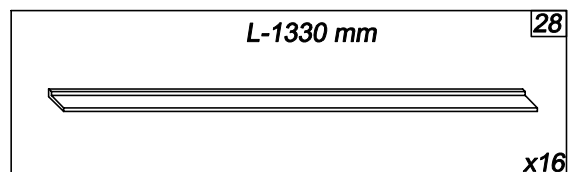
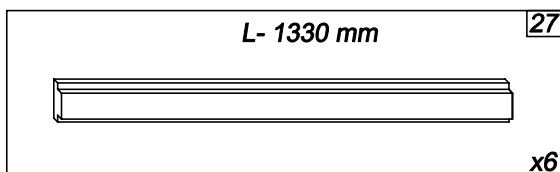
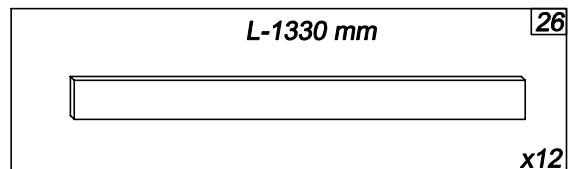
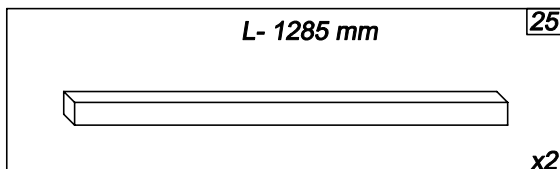
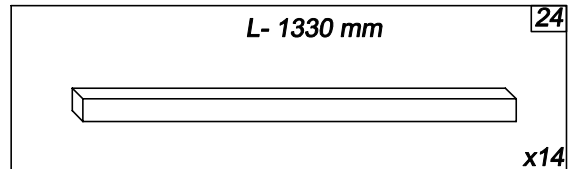
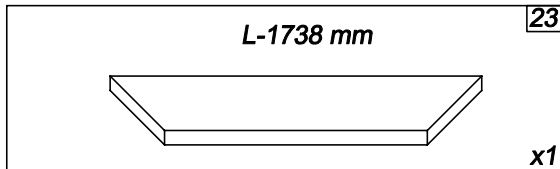
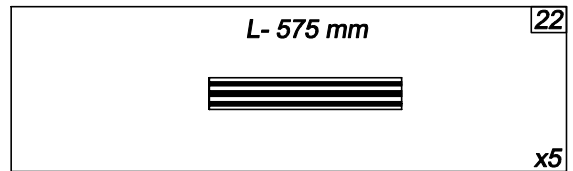
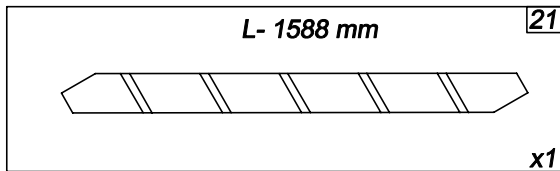
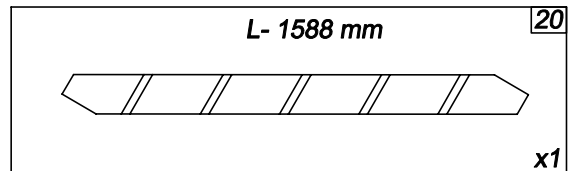
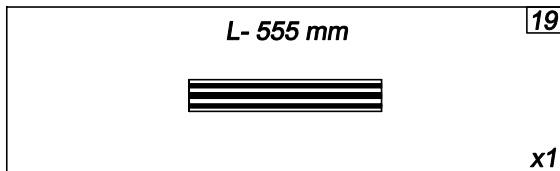
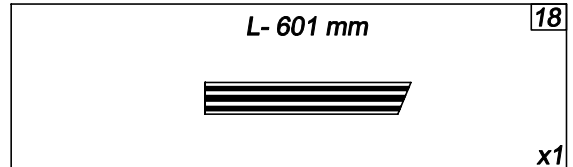
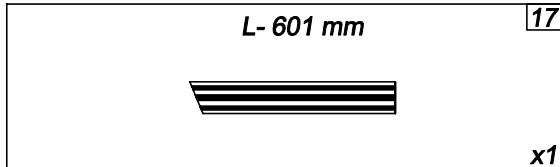
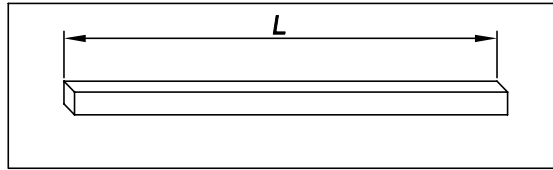

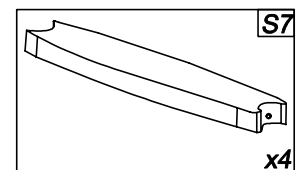
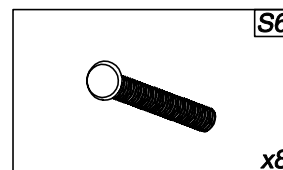
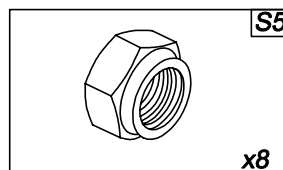
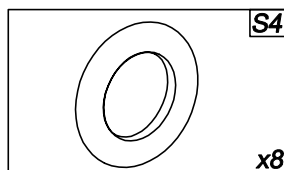
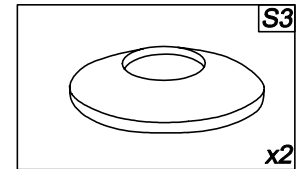
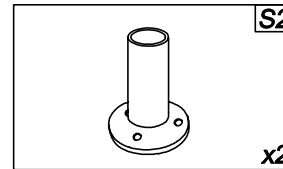
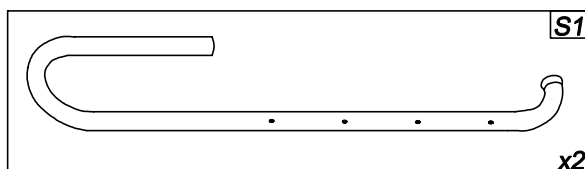
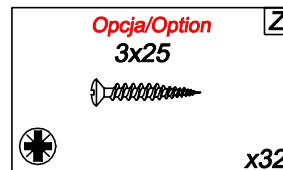
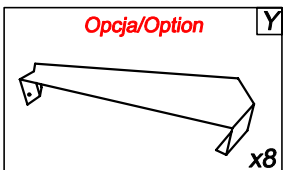
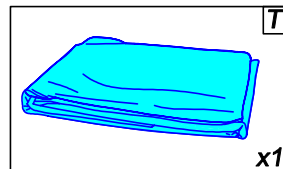
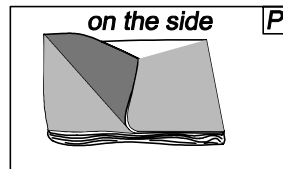
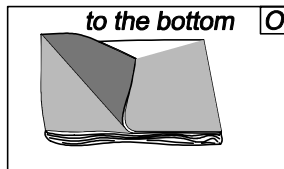
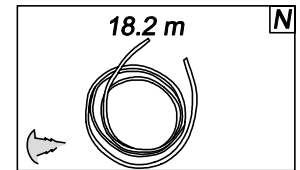
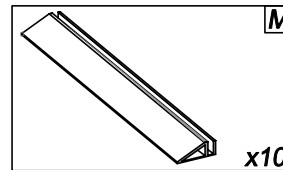
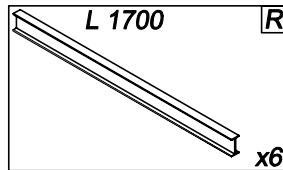
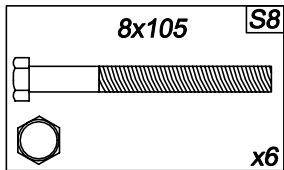
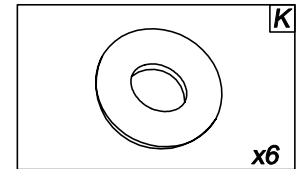
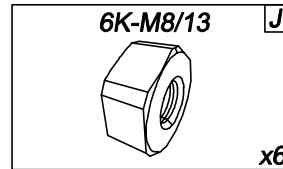
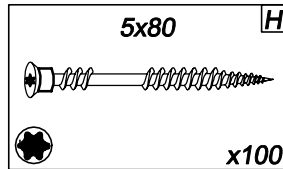
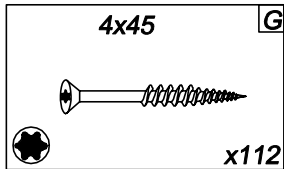
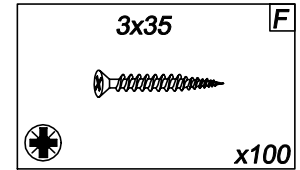
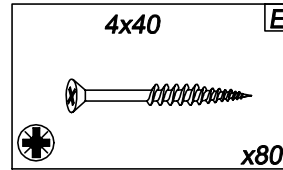
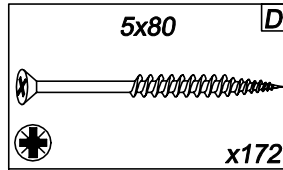
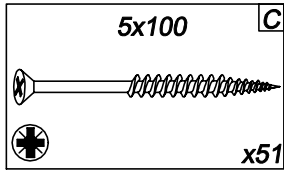
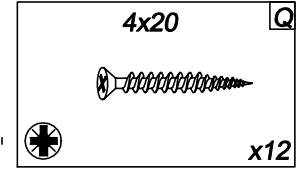
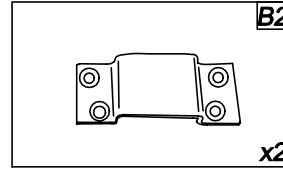
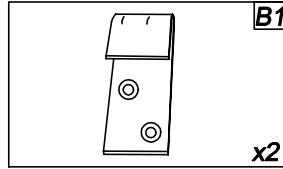
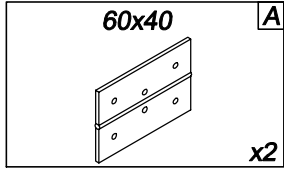

PL Elementy

GB Elements

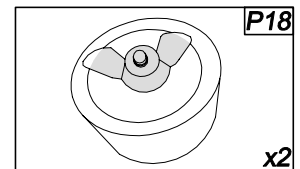
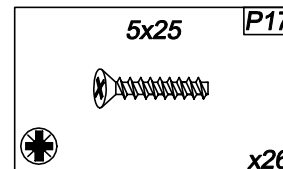
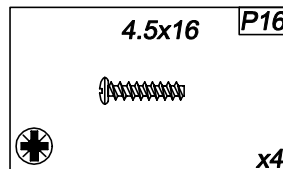
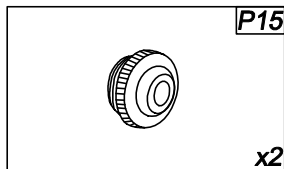
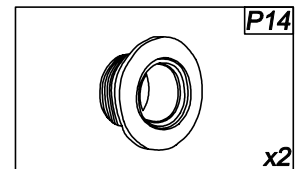
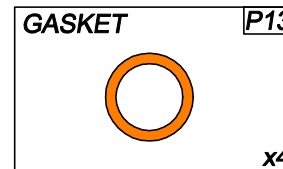
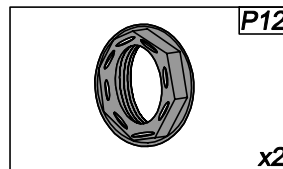
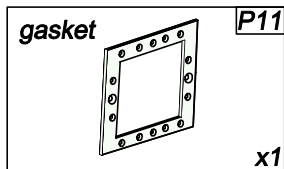
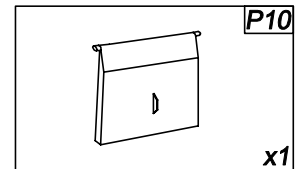
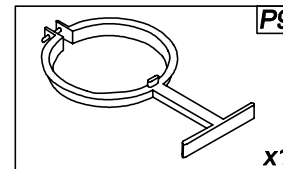
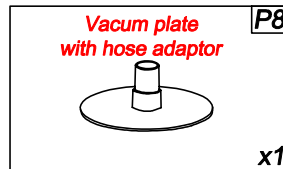
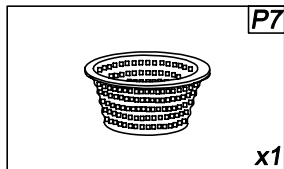
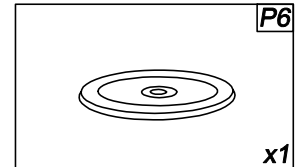
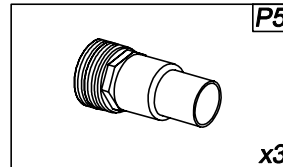
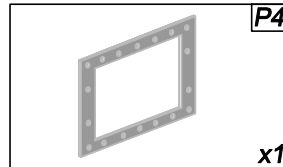
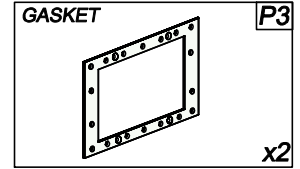
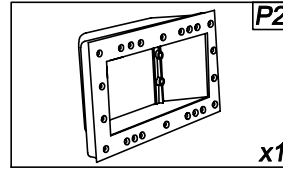
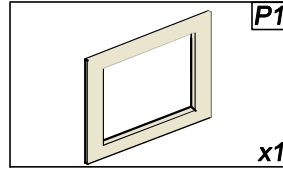
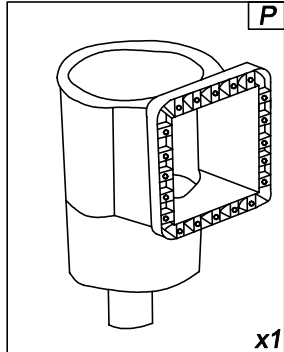

UWAGA / NOTE
PL Widok po zmontowaniu.
GB After installation.

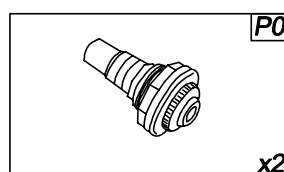
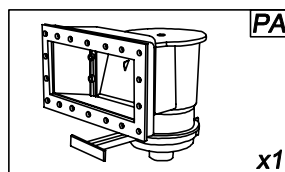

PL Zatyckza dyszy

GB Rubber plug

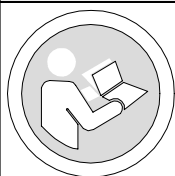

ZATYCKZA DO DYSZY - w celu przygotowania basenu do sezonu zimowego (w szczególności przy ryzyku zamarznięcia wody) zastosuj zatyckzkę do dysz napływowych, odcinając dopływ wody do zestawu filtracyjnego. **Pozostaw dyszę w basenie, zamontuj zatyckzkę.** Należy pamiętać również o odłączeniu zestawu filtracyjnego od źródła wody i dokładnym osuszeniu dysz od strony zewnętrznej. Zaleca się także, aby z pompy jak i dołączonego filtra piaskowego na okres zimy (w miejscach gdzie występują mrozy) usunąć pozostałości wody, w innym przypadku zamarzająca woda może dokonać zniszczenia całości zestawu.

Rubber plug - in order to prepare the pool for the winter season (especially if there is a risk of freezing) put a plug into the inlet to shut off the access of water to the filtration system. **Inlet must remain in the pool.**

Fix the plug under water. Remember to disconnect the filtration set from the pool and dry the inlet (the part of inlet which is outside of the pool). For the winter season, it is recommended to get rid of water remaining in pump and sand filter, otherwise freezing water can cause devastation of the whole set.

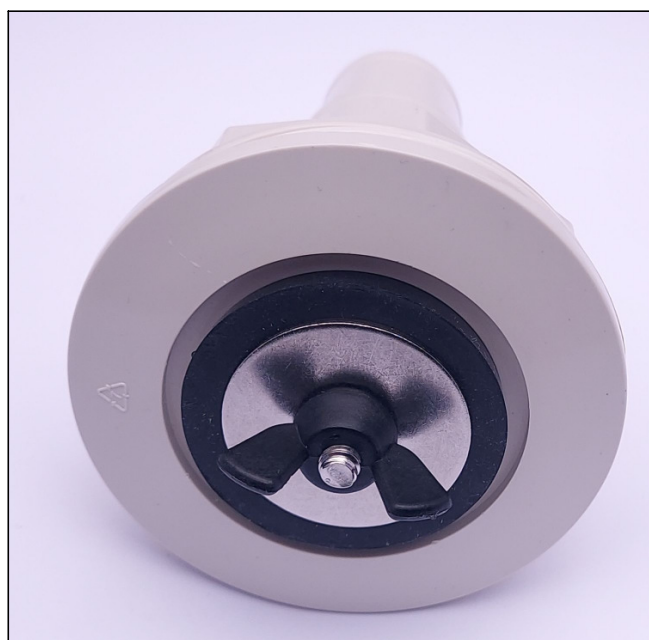
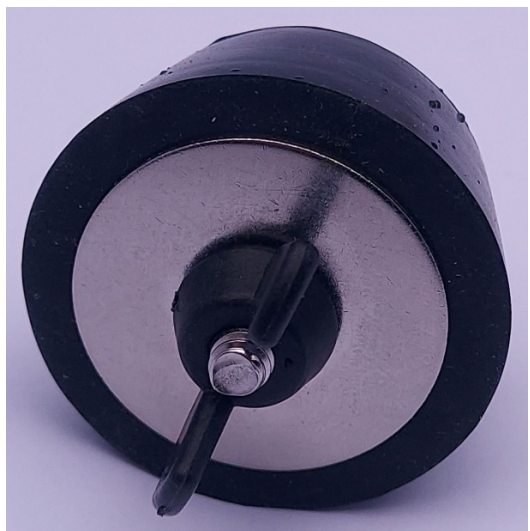
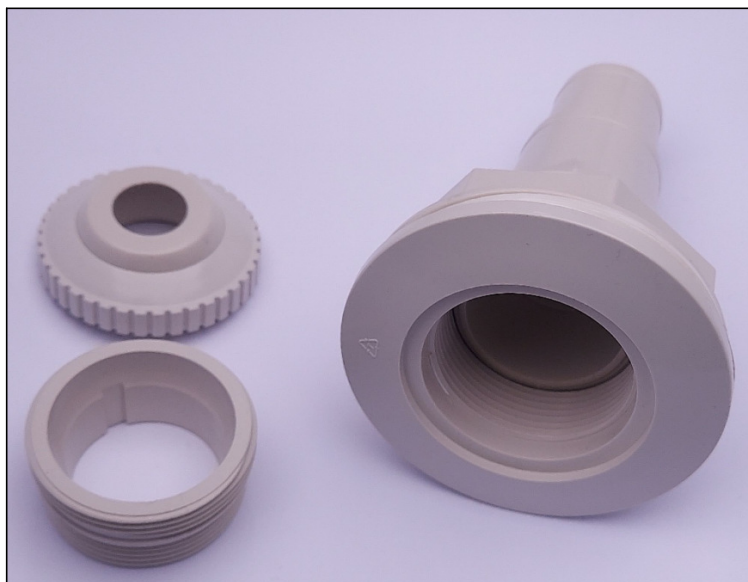

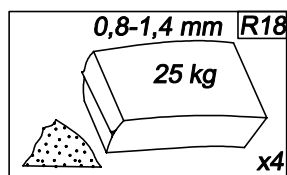
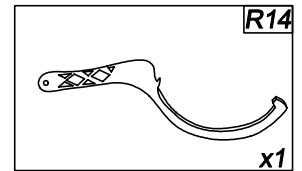
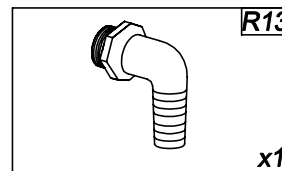
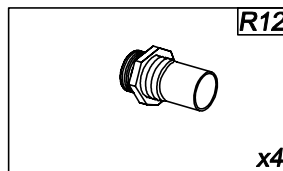
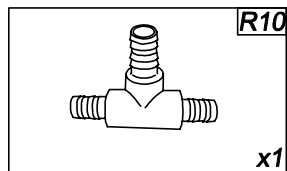
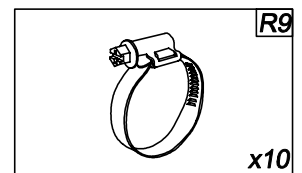
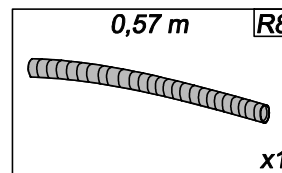
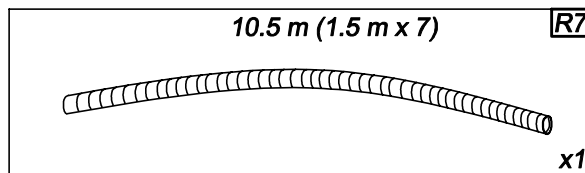
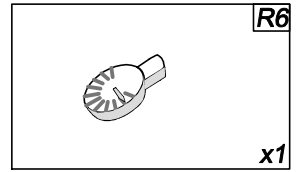
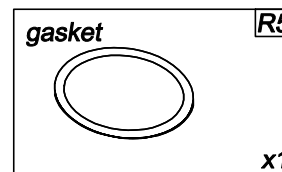
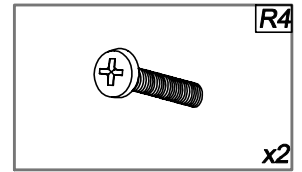
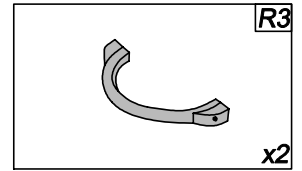
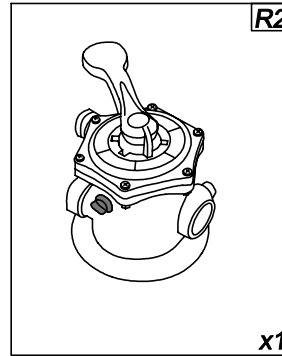
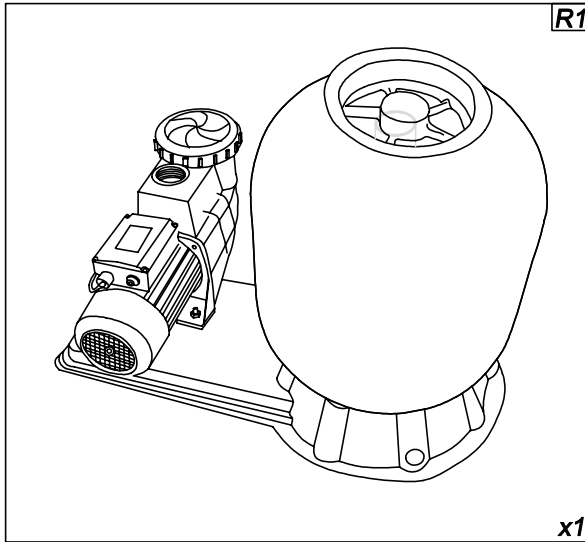

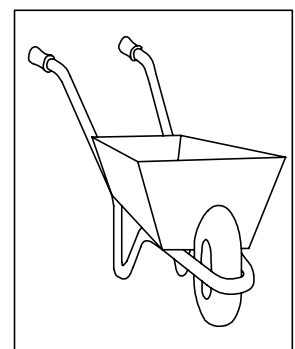
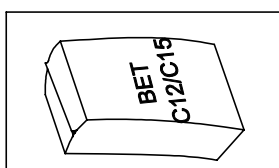
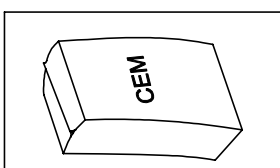
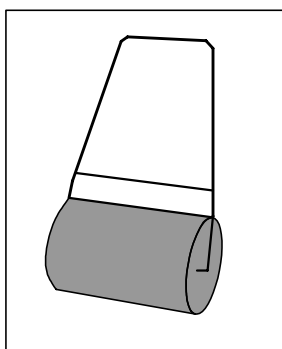
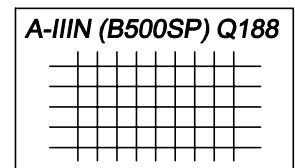
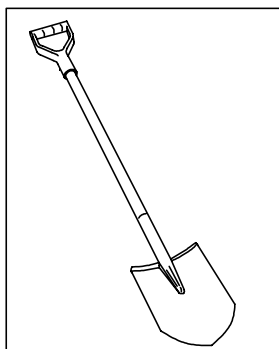
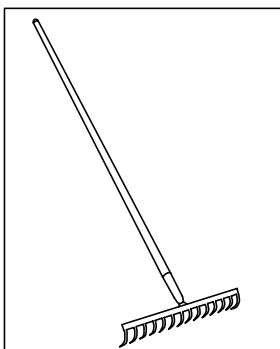
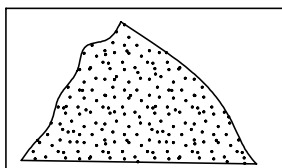
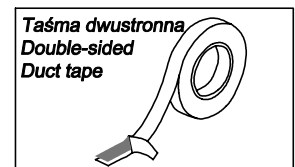
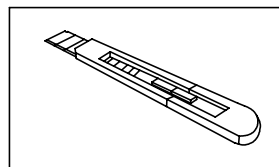
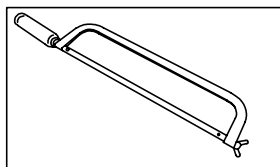
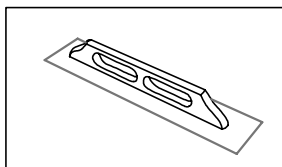
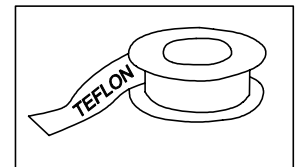
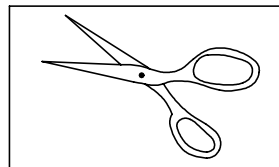
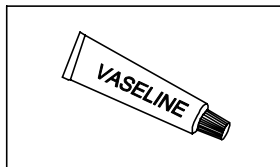
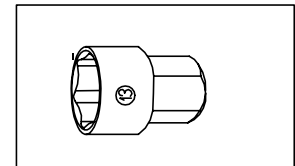
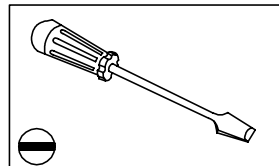
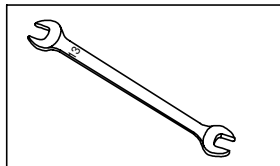
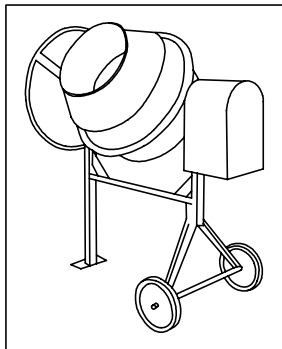
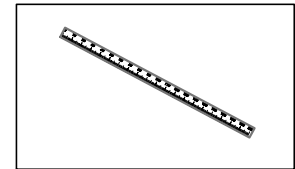
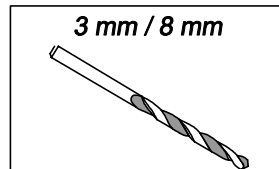
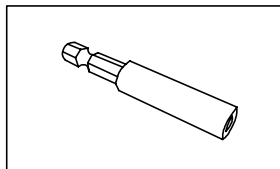
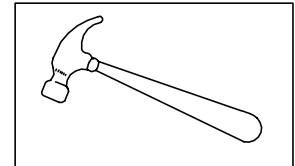
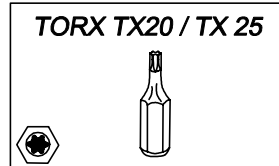
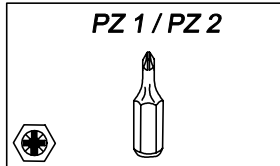
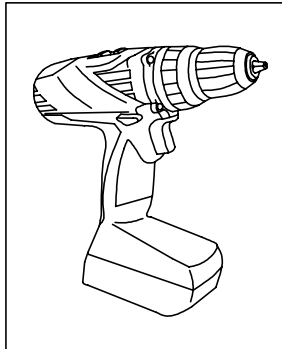
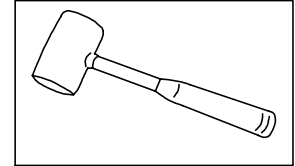
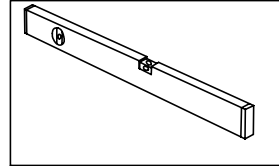
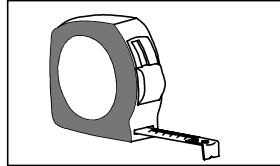
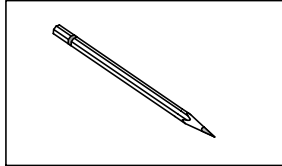

PL Podłoże

GB Ground

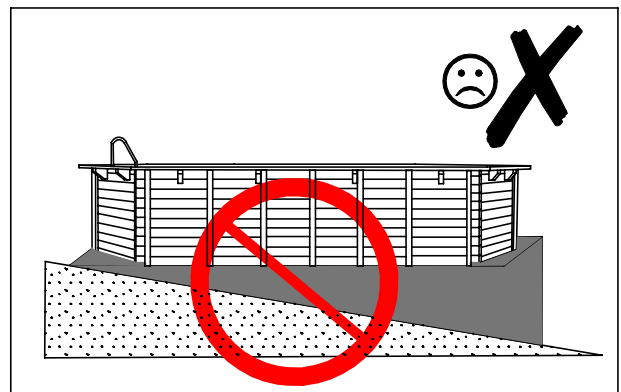
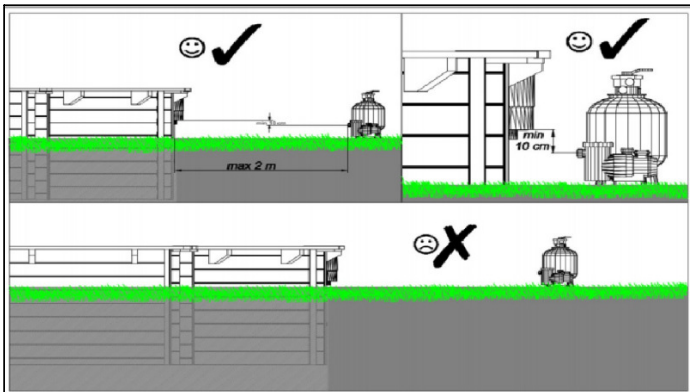
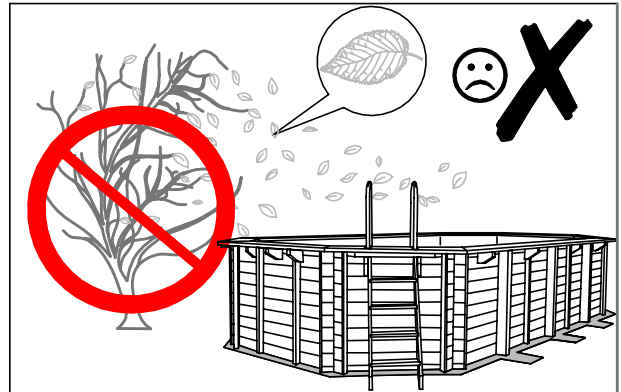
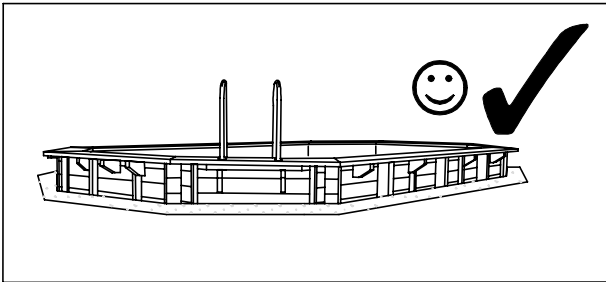
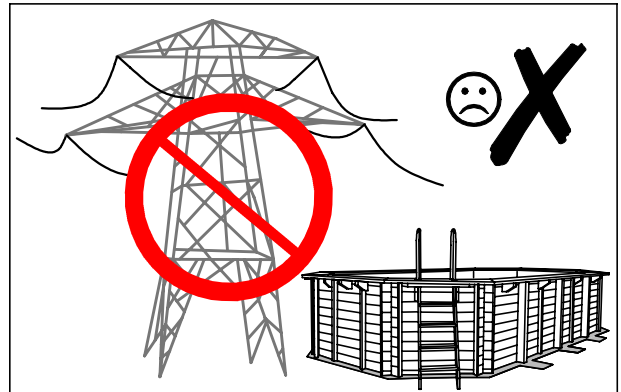
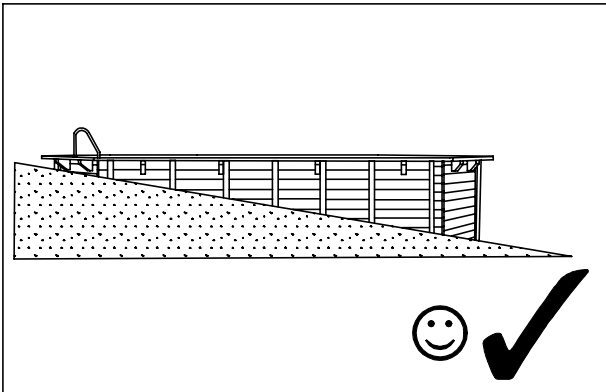
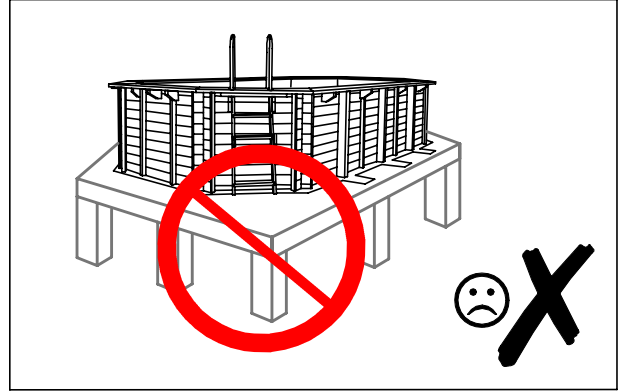
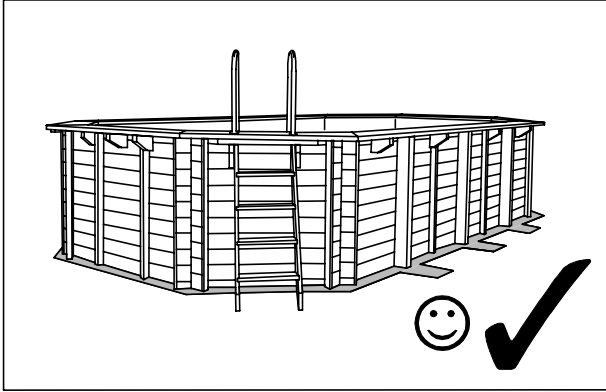



- 1 FUNDAMENT BASENU / FUNDATION
- 2 RURA DRENARSKA / DRAINAGE PIPE
- 3 PEŁCZERZYKOWA FOLIA FUNDAMENTOWA / FOUNDATION BUBBLE WRAP
- 4 ŻWIR / GRAVEL
- 5 GEOWŁÓKNINA OGRODOWA / GEOTEXTILE
- 6 GRUNT / GROUND

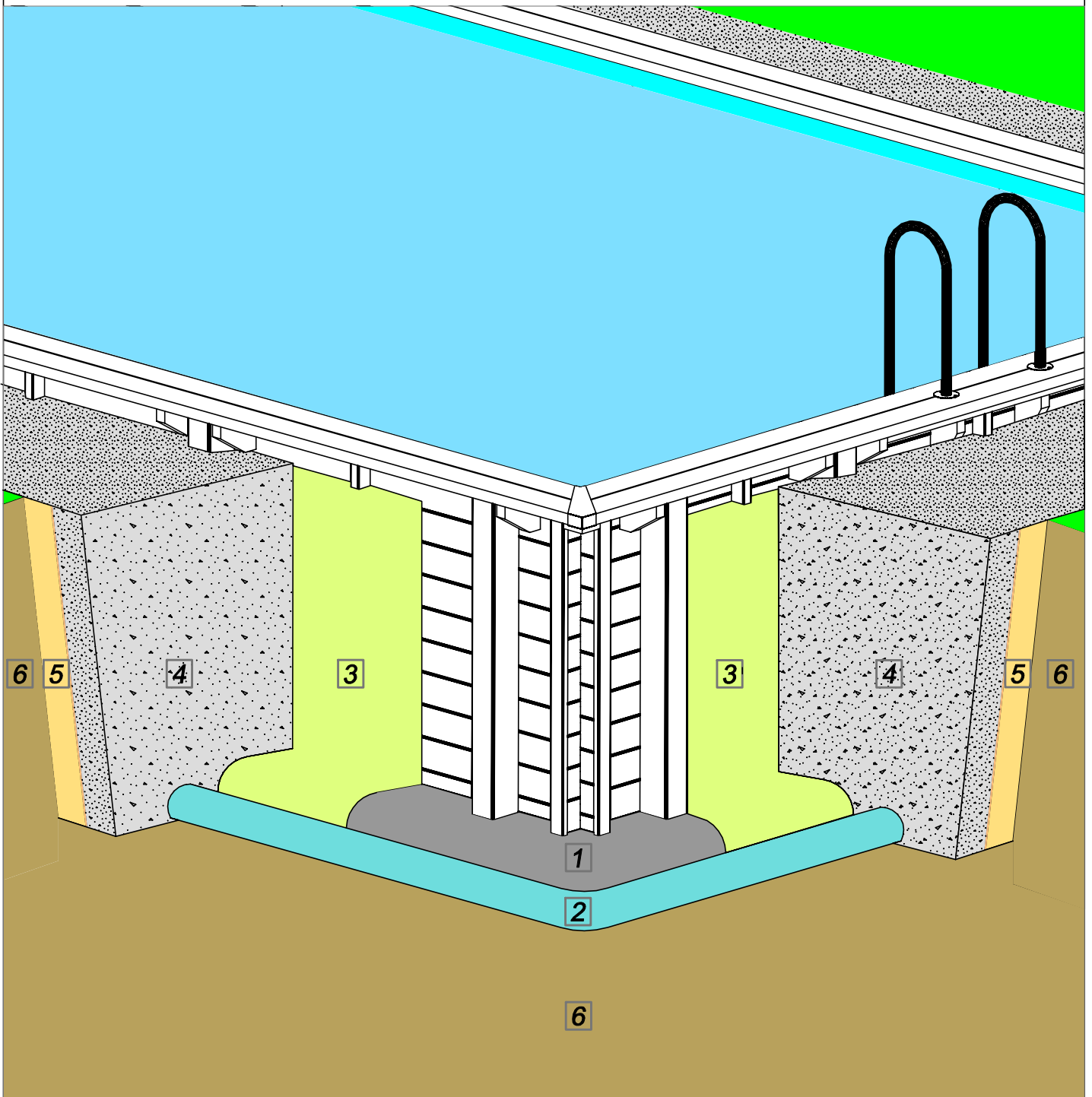

PL Podłoże

GB Ground

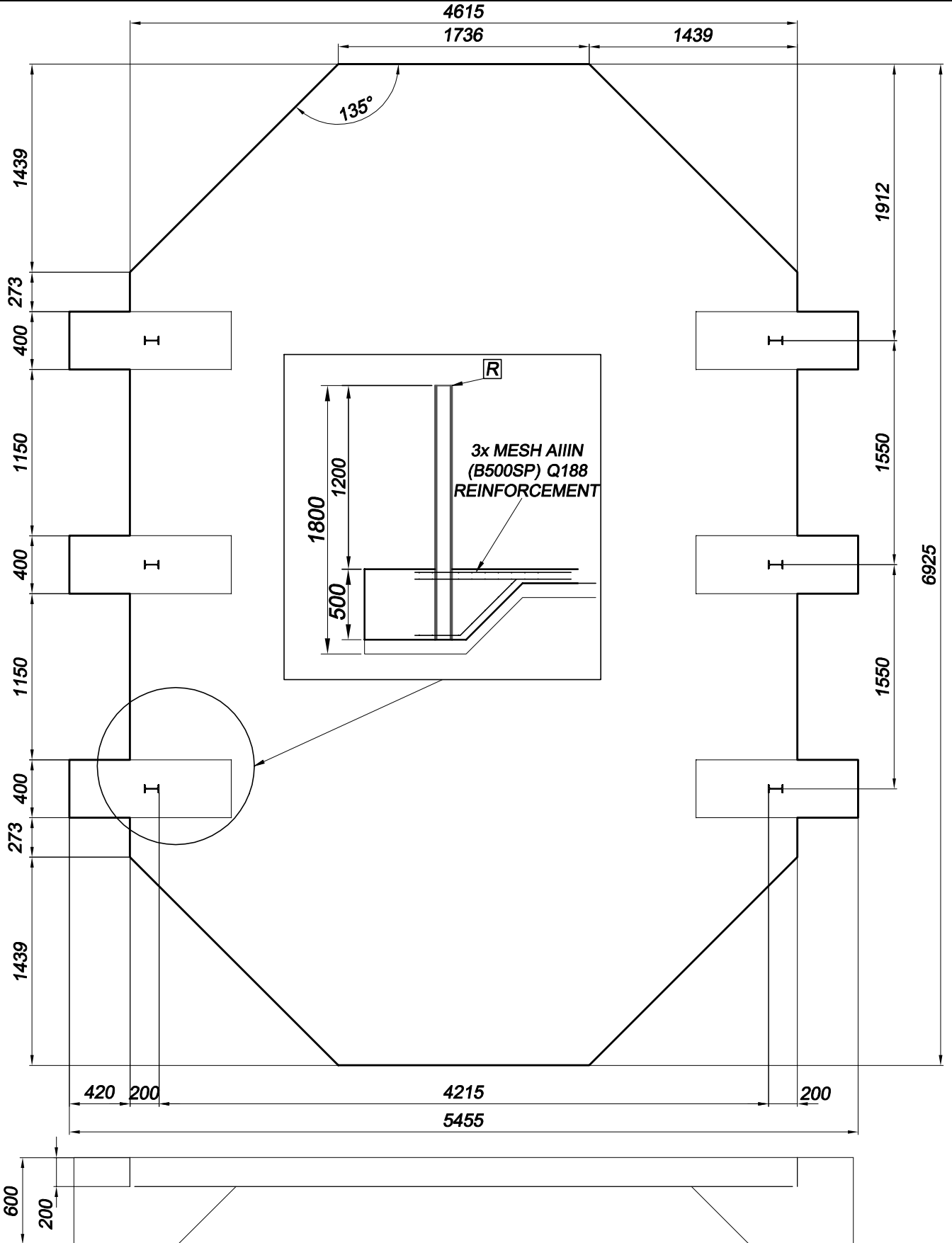

PL Podłoże

GB Ground

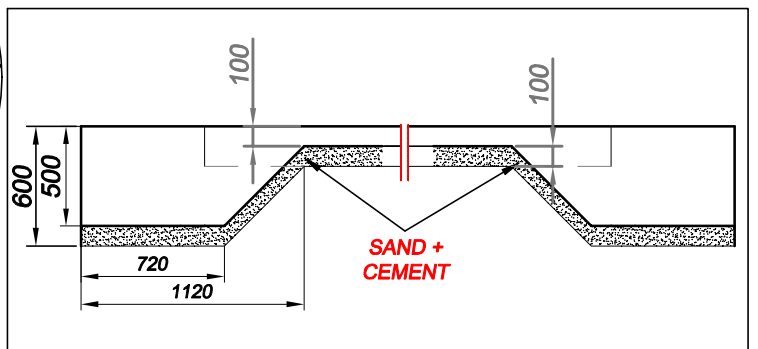
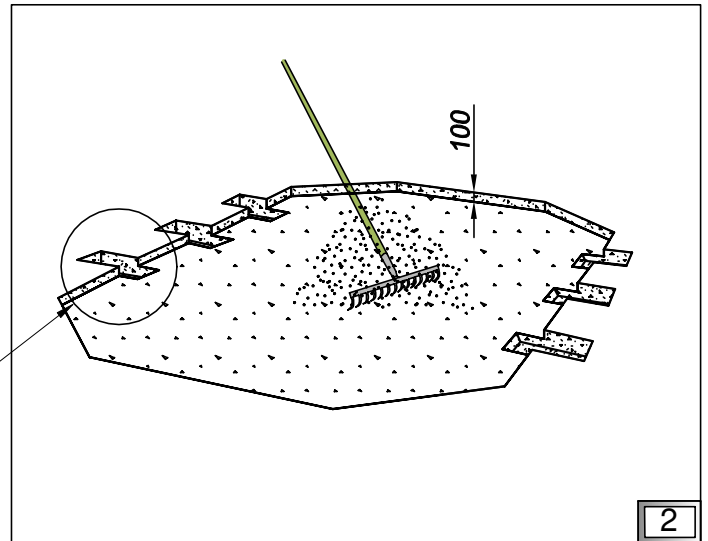
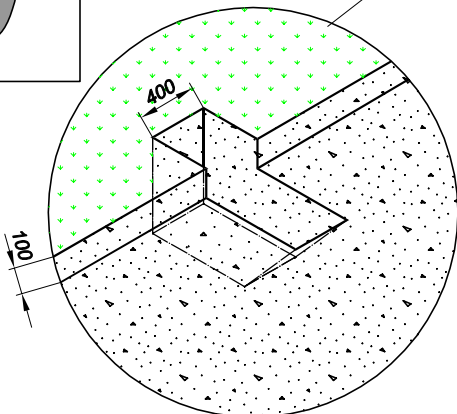
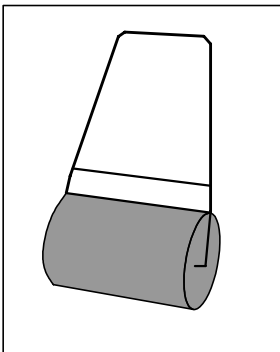
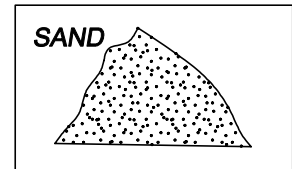
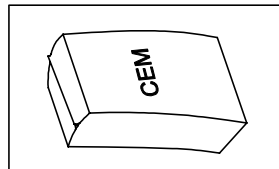
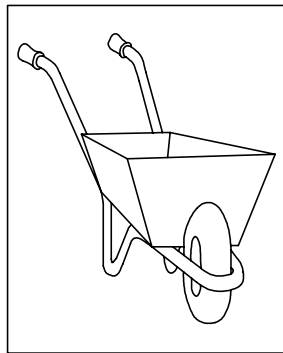
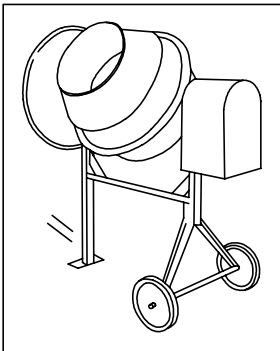
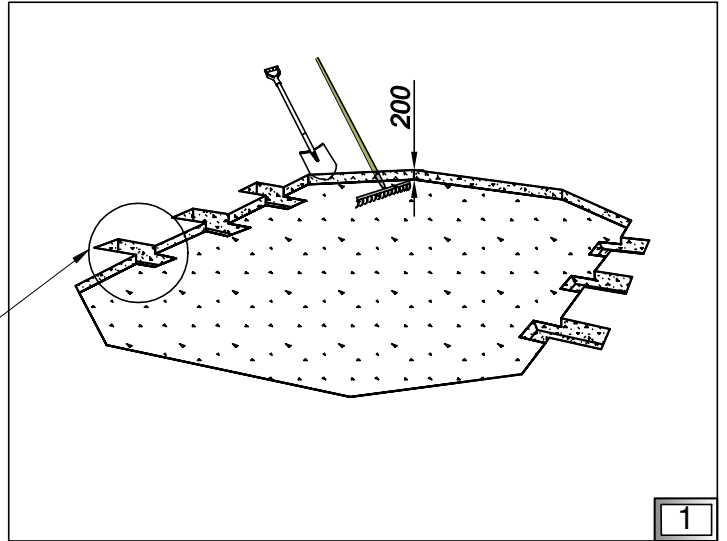
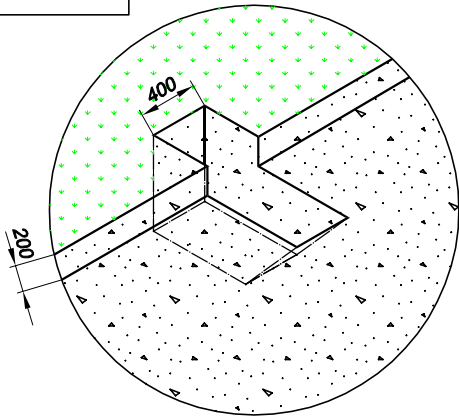
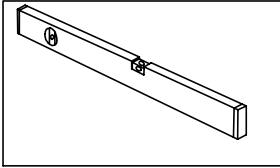

PL Podłoże

GB Ground

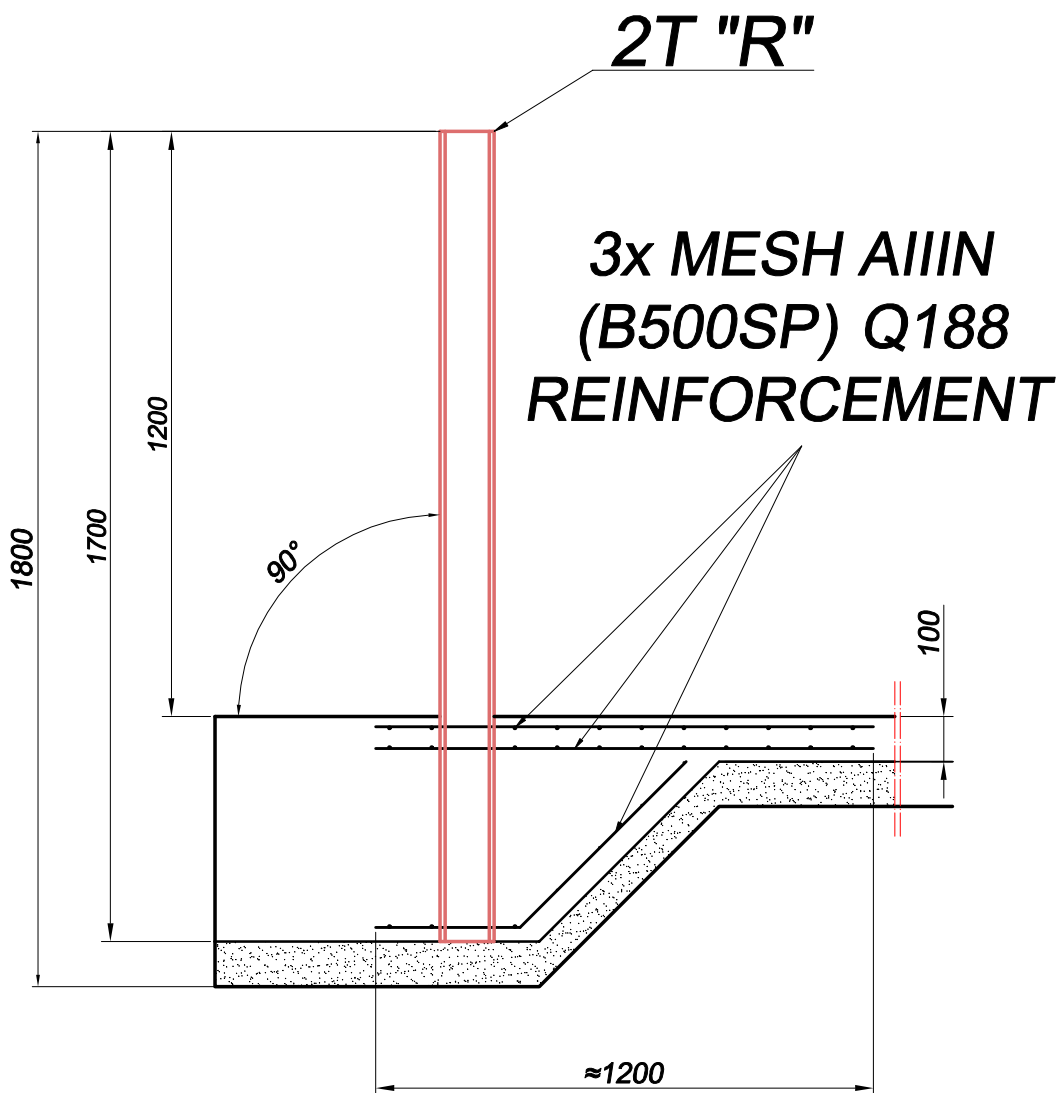

PL Podłozie

GB Ground

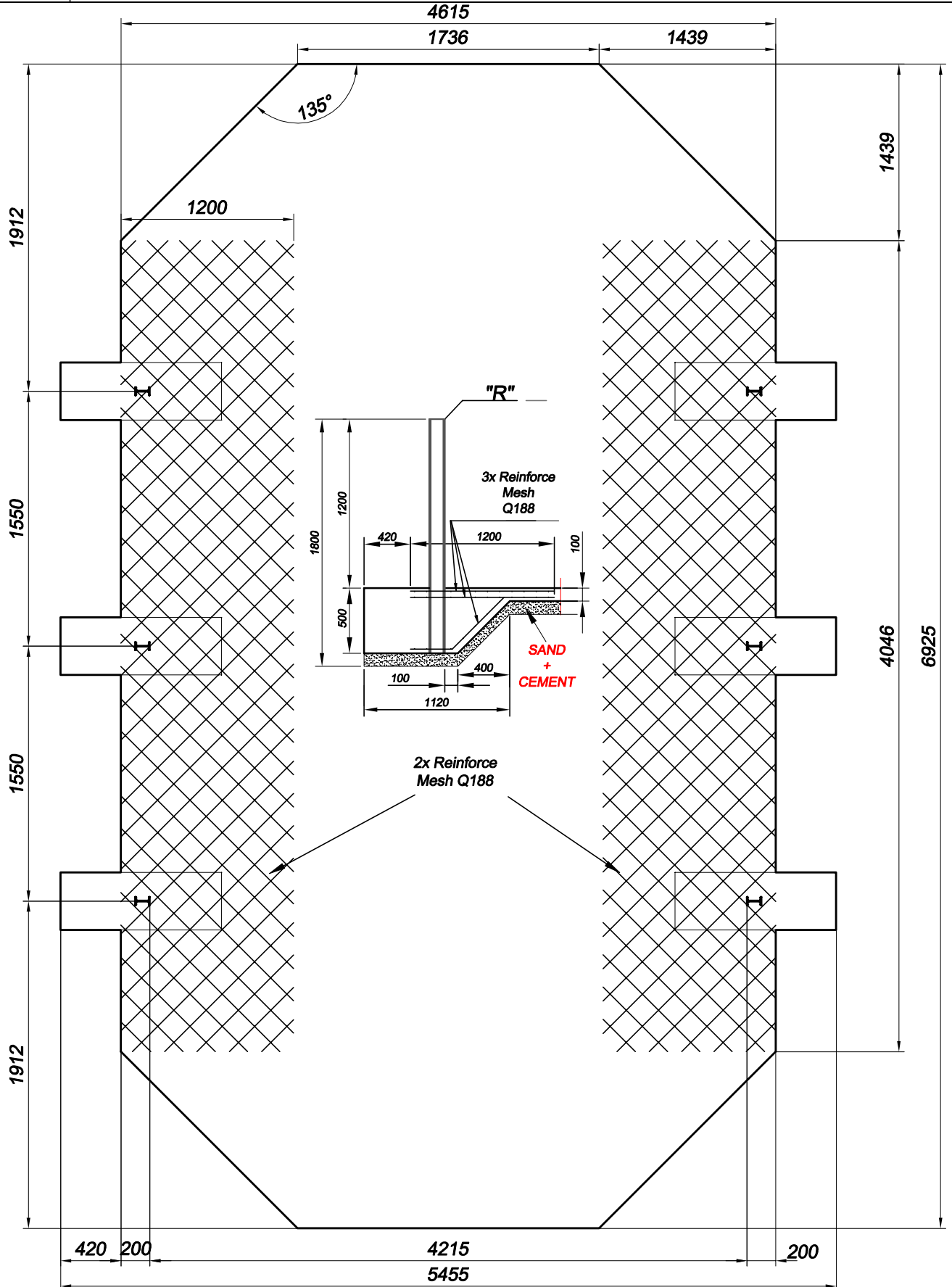

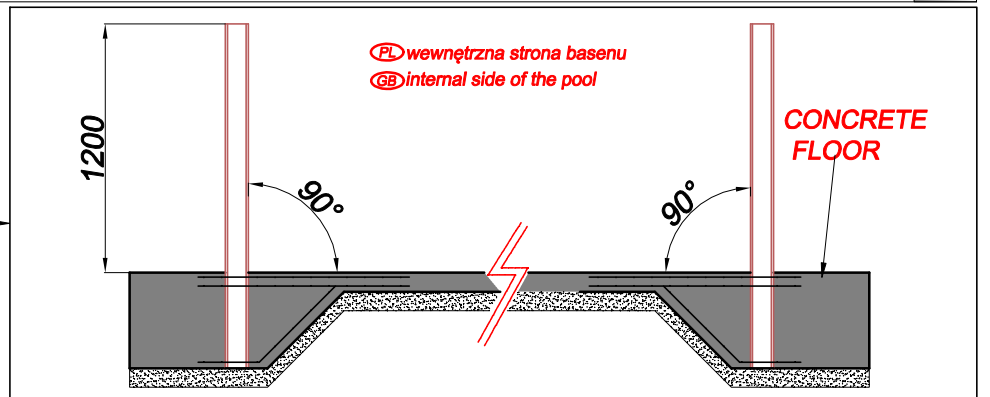
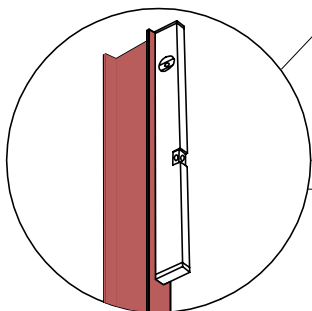
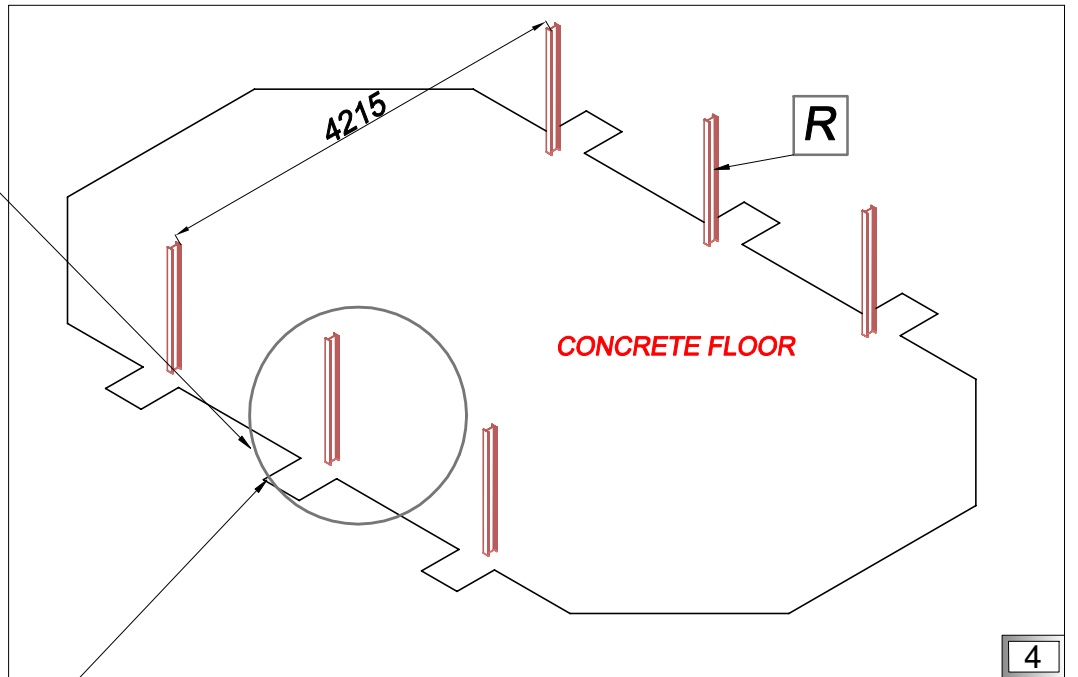
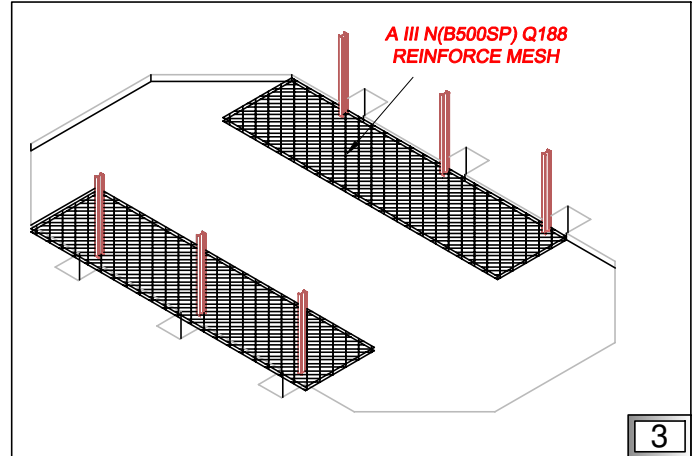
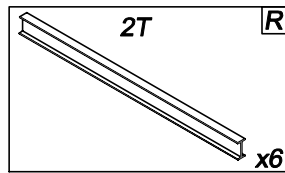
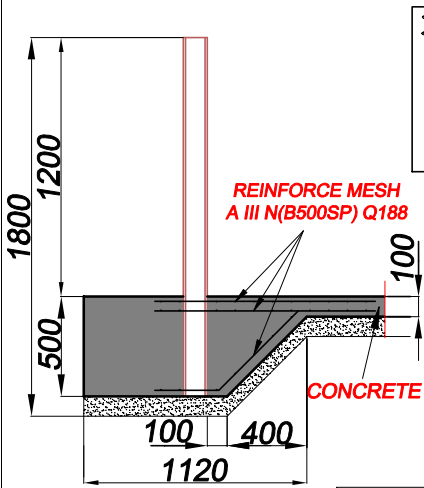
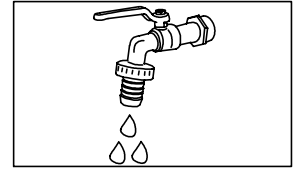
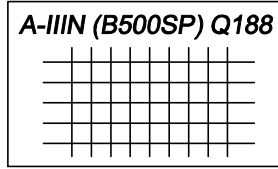
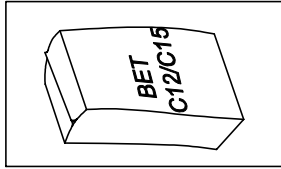

PL Podłoże

GB Ground

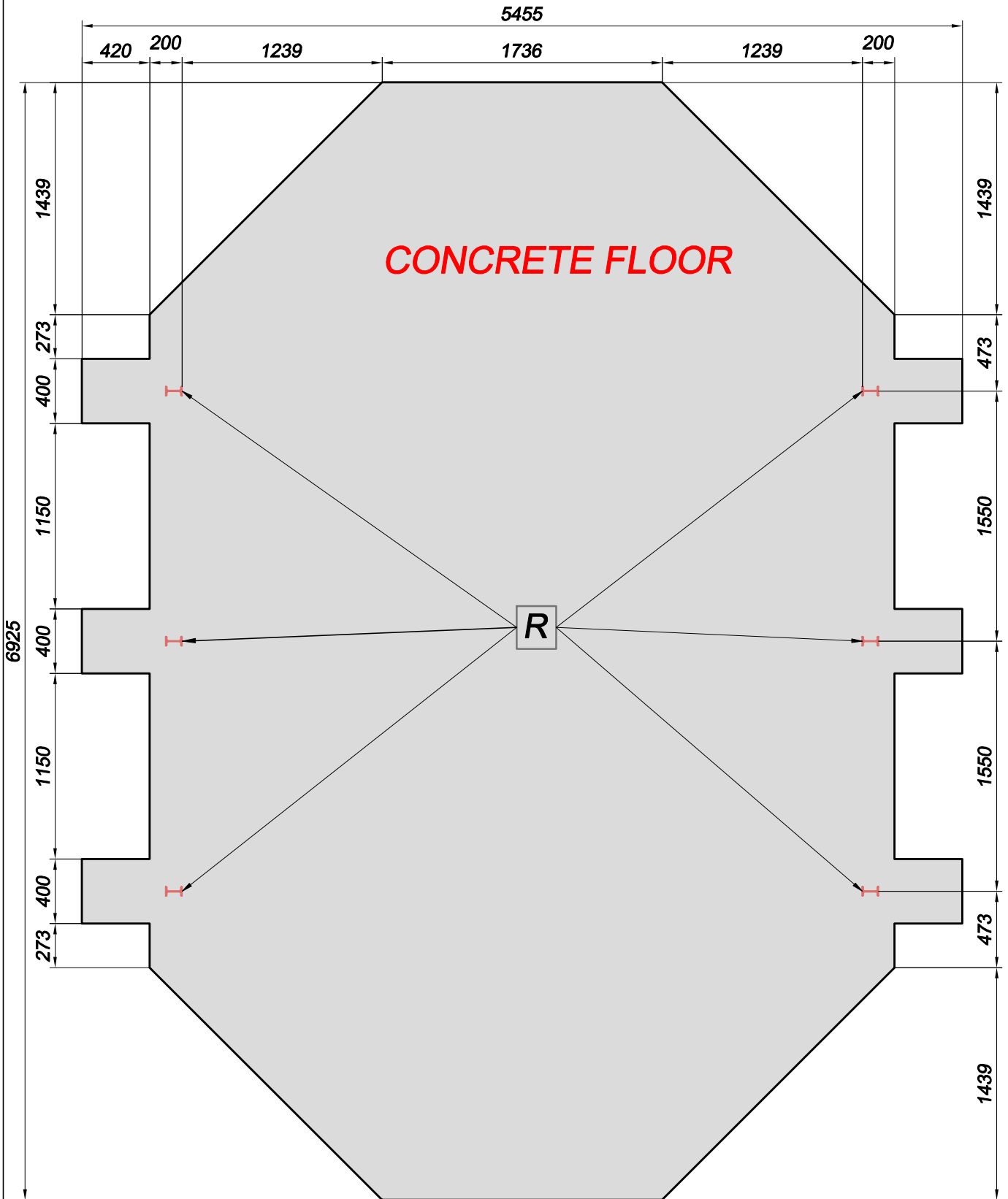

PL Struktura drewniana

GB Wooden structure



I

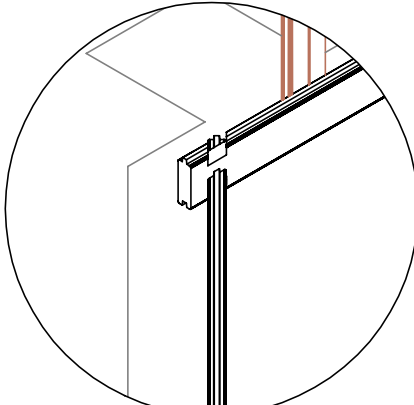
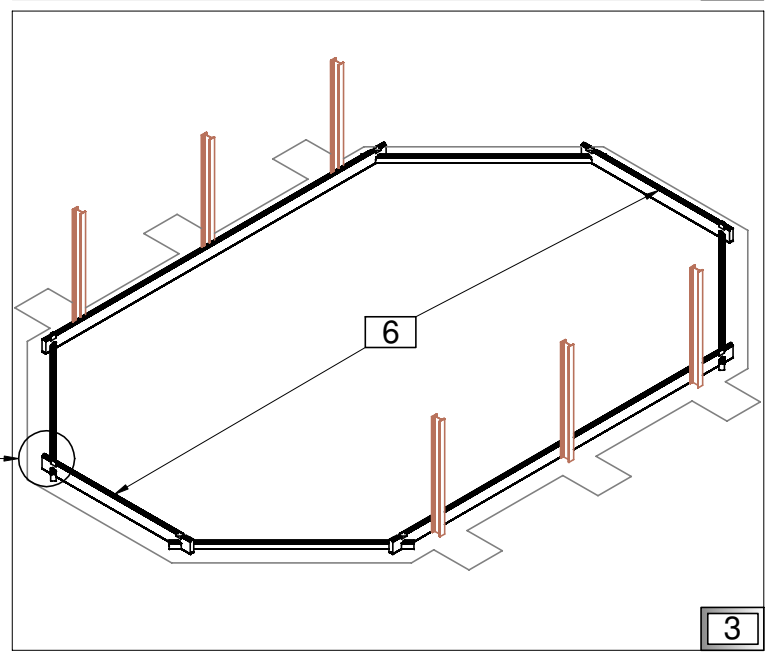
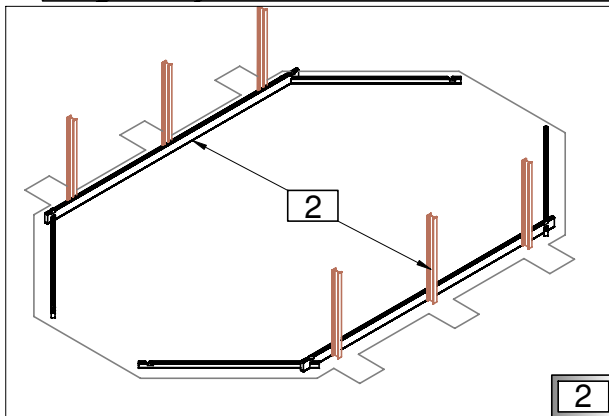
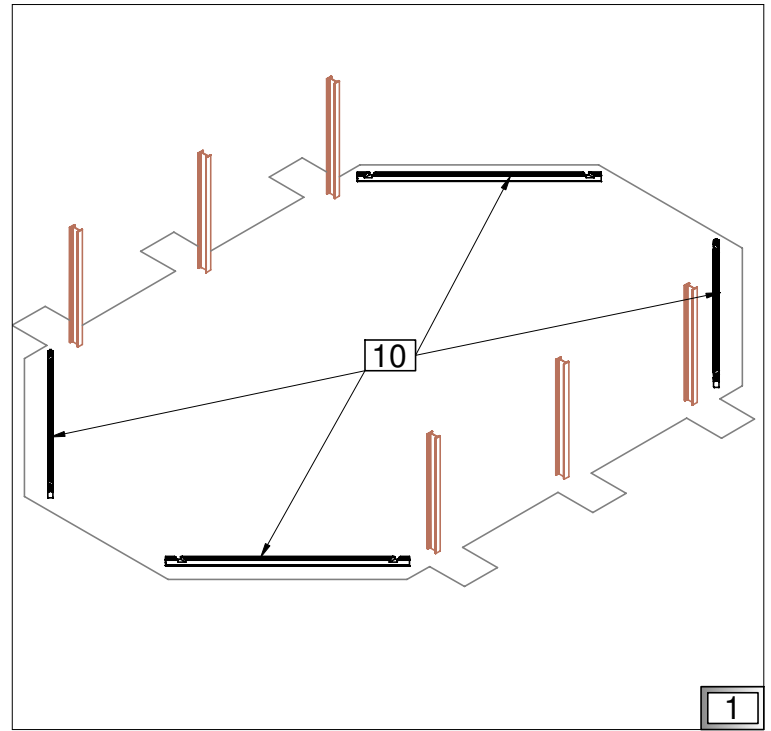
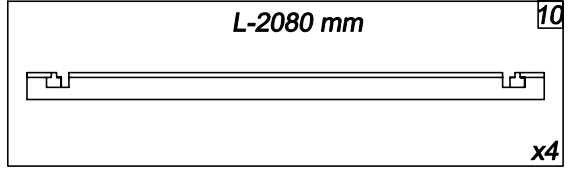
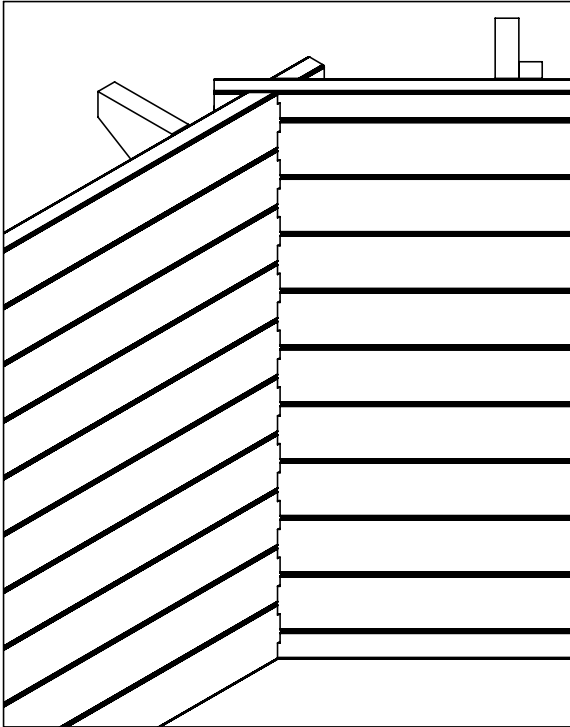
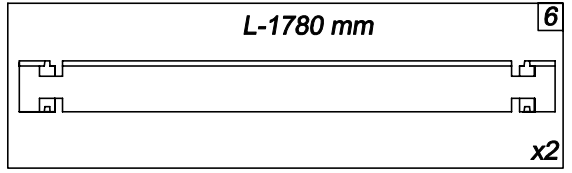
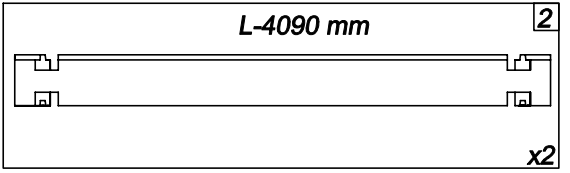

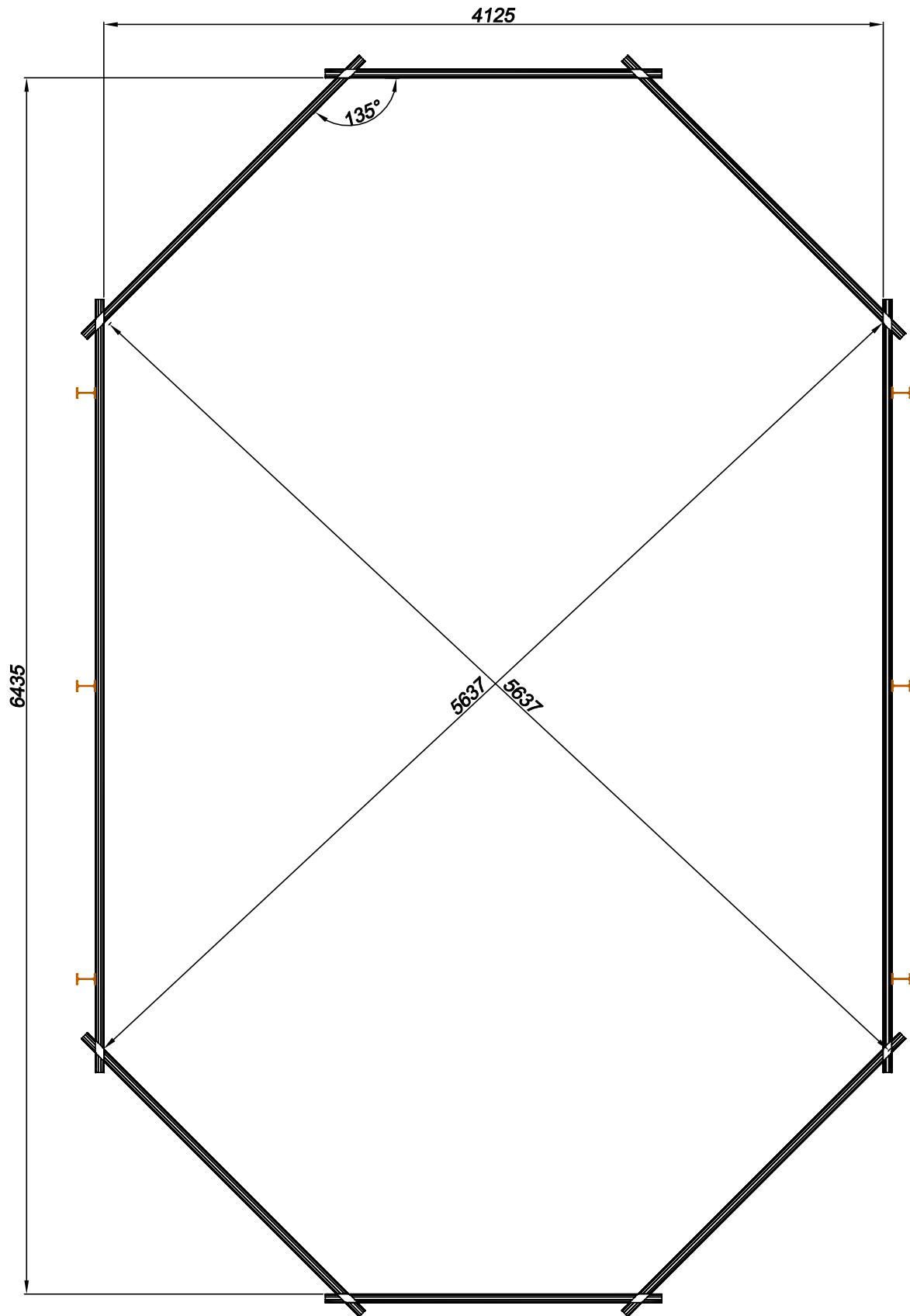



II-IV

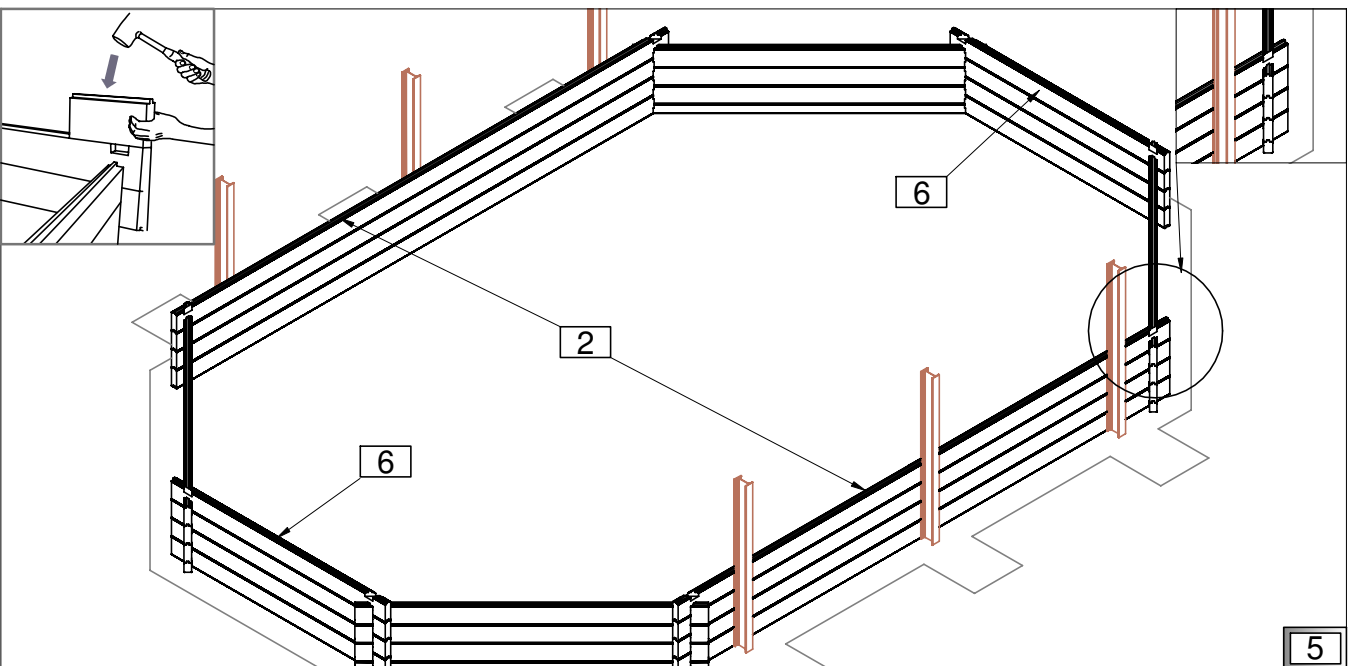
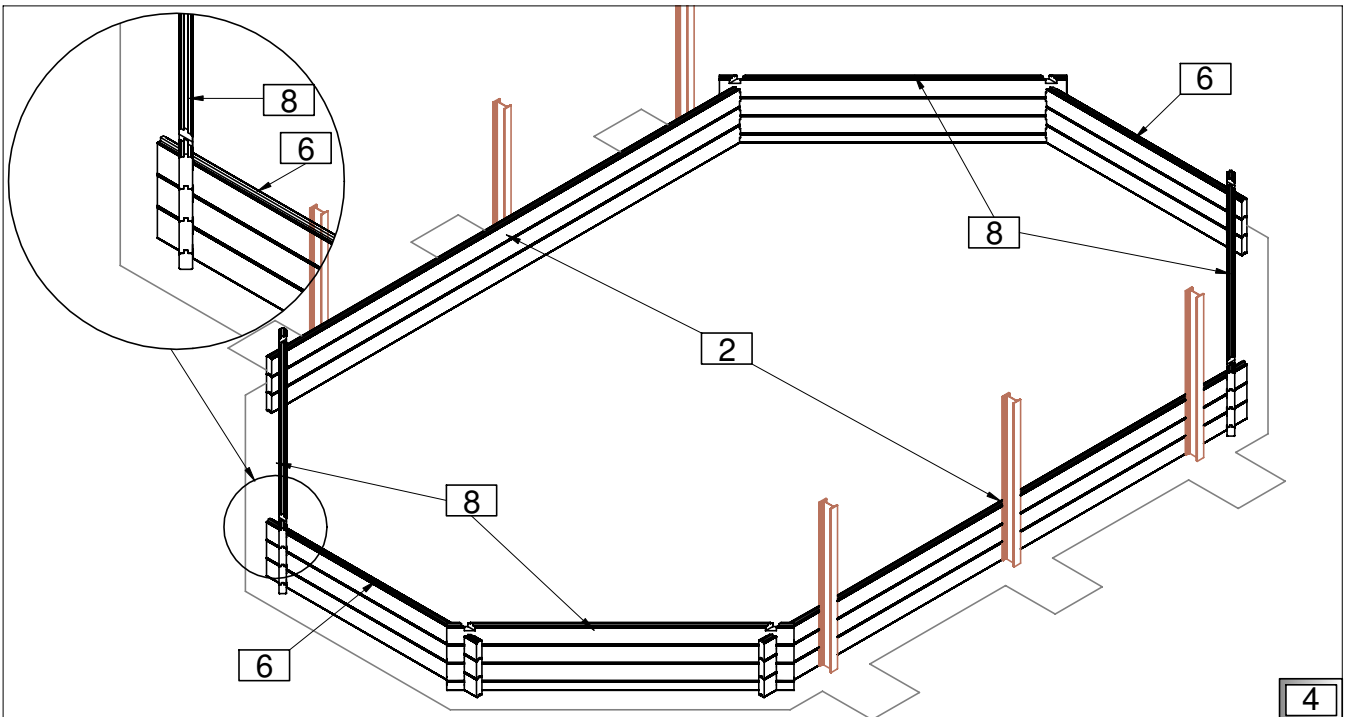
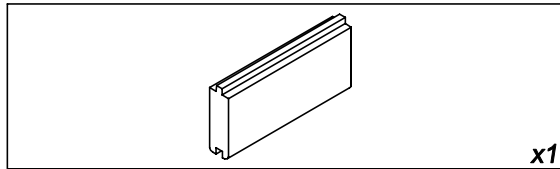
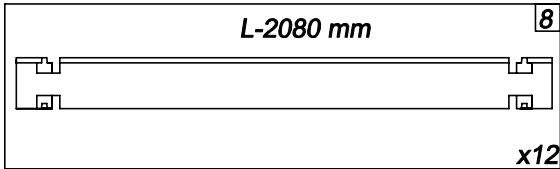
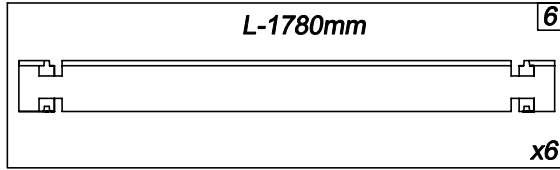
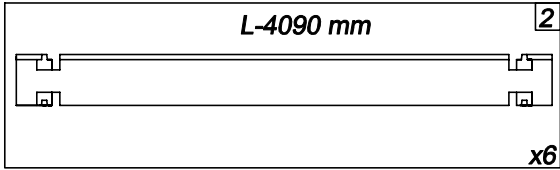

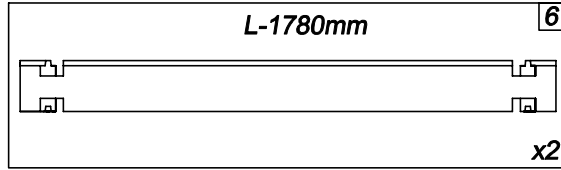
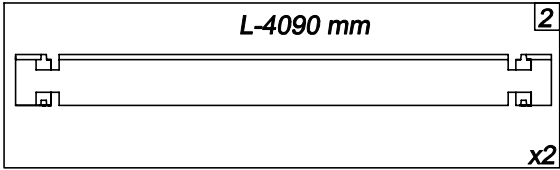

V

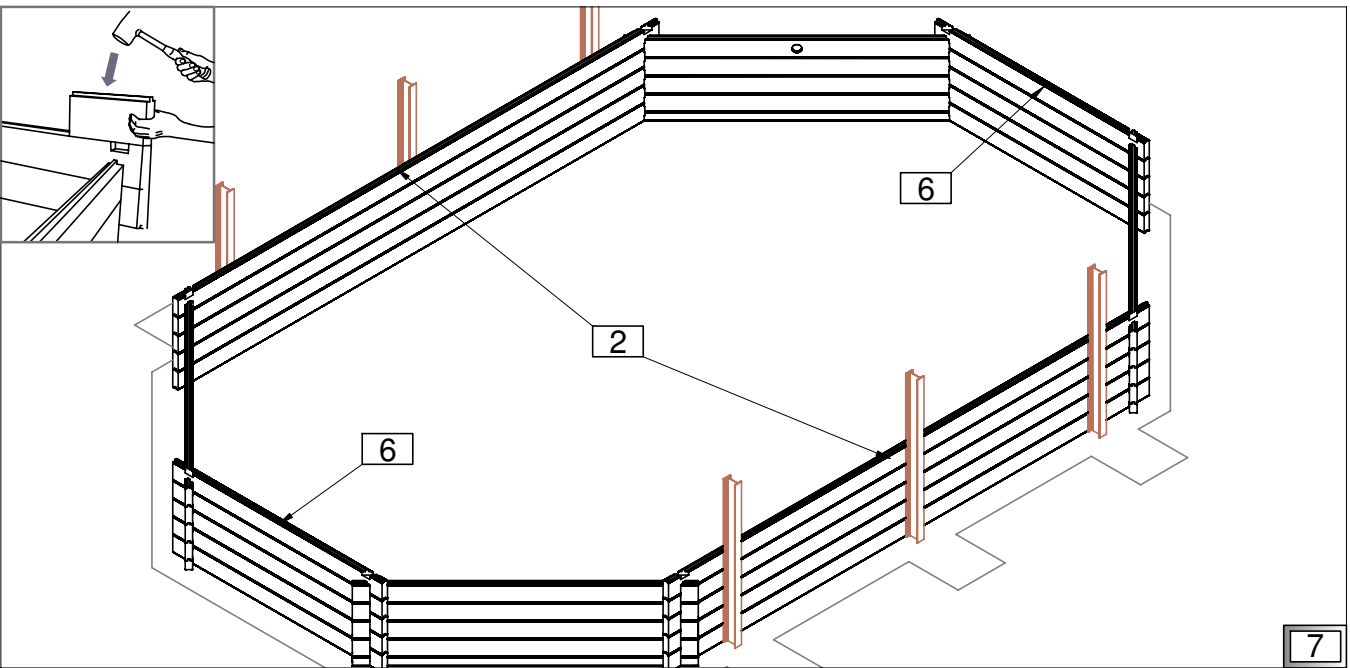
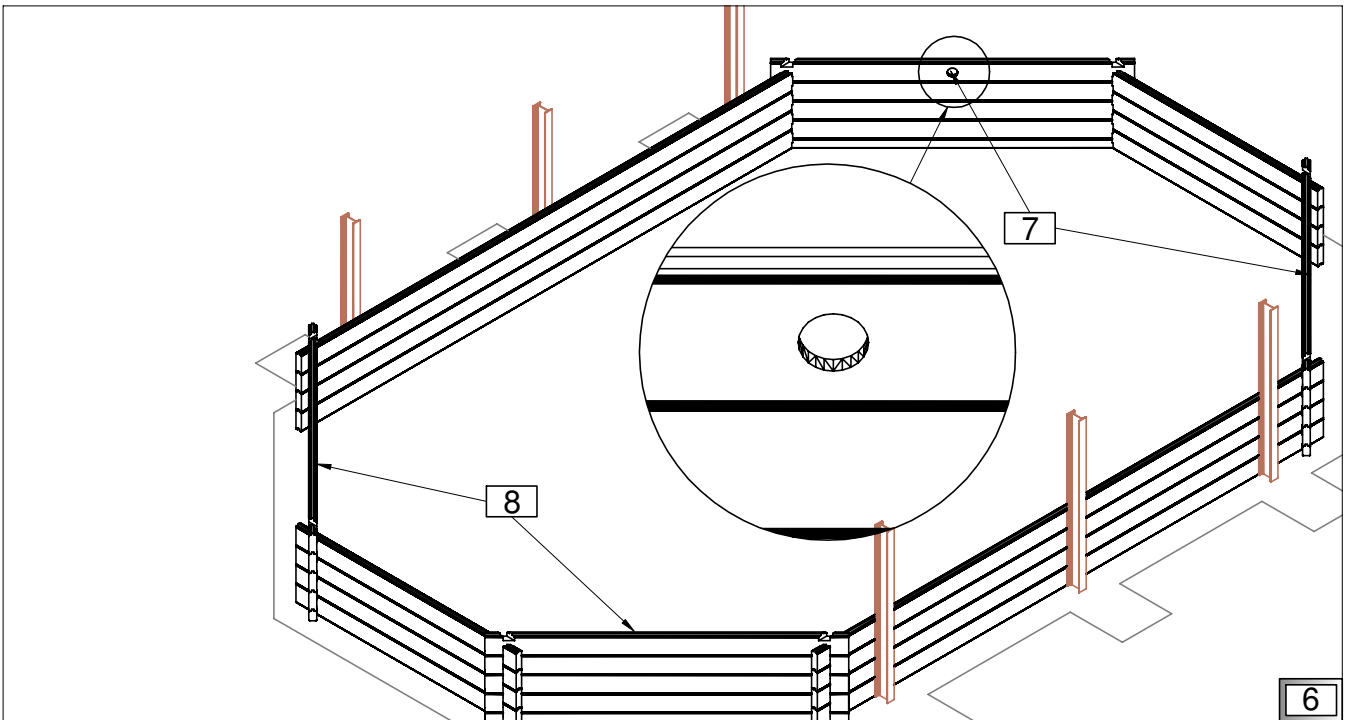
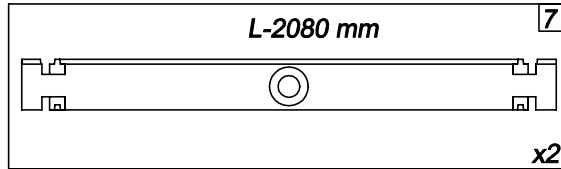
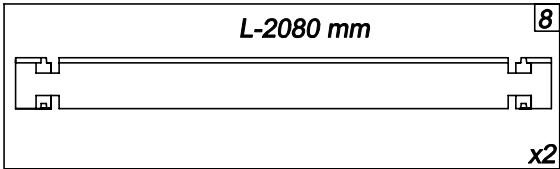

PL Struktura drewniana

GB Wooden structure



VI-VIII

L-4090 mm

2

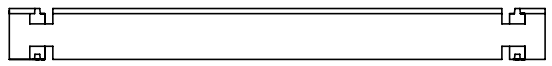

x6

L-1780mm

6

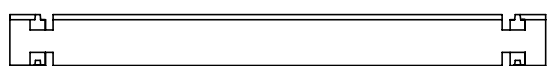

x6

L-2080 mm

8

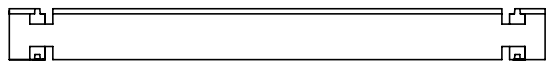

x12

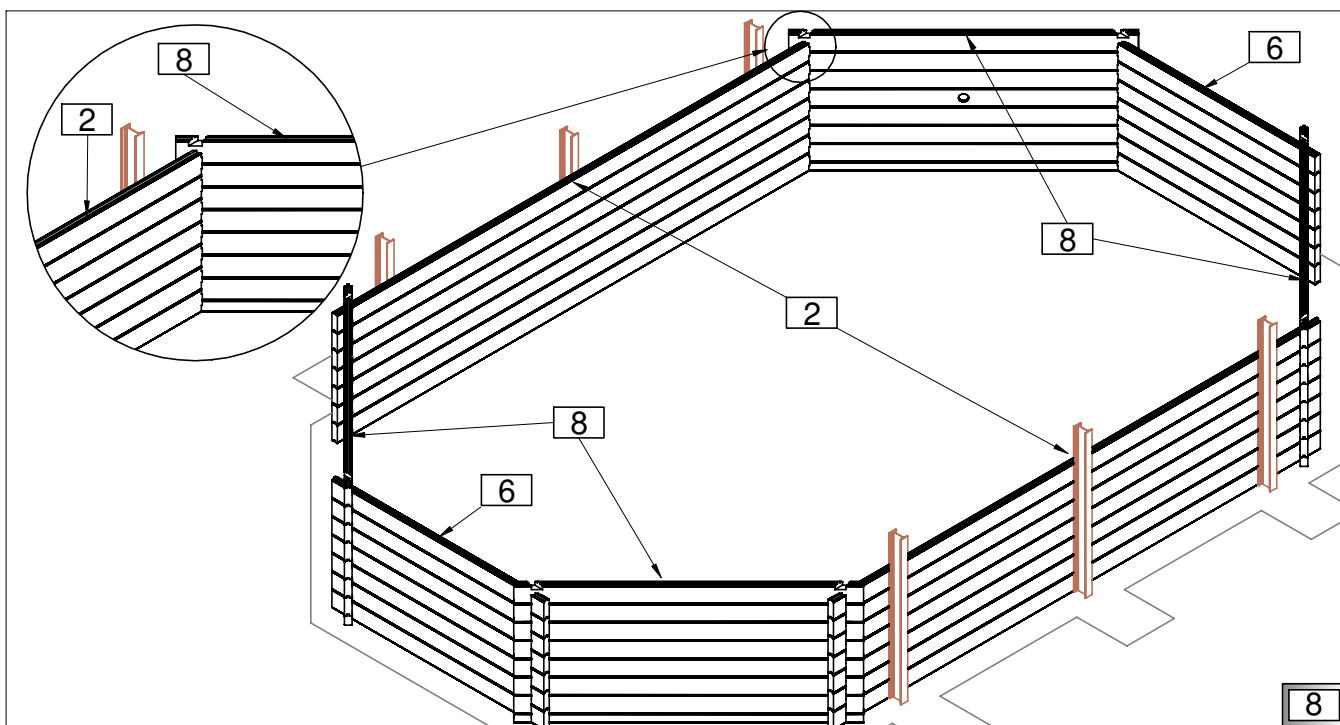

8

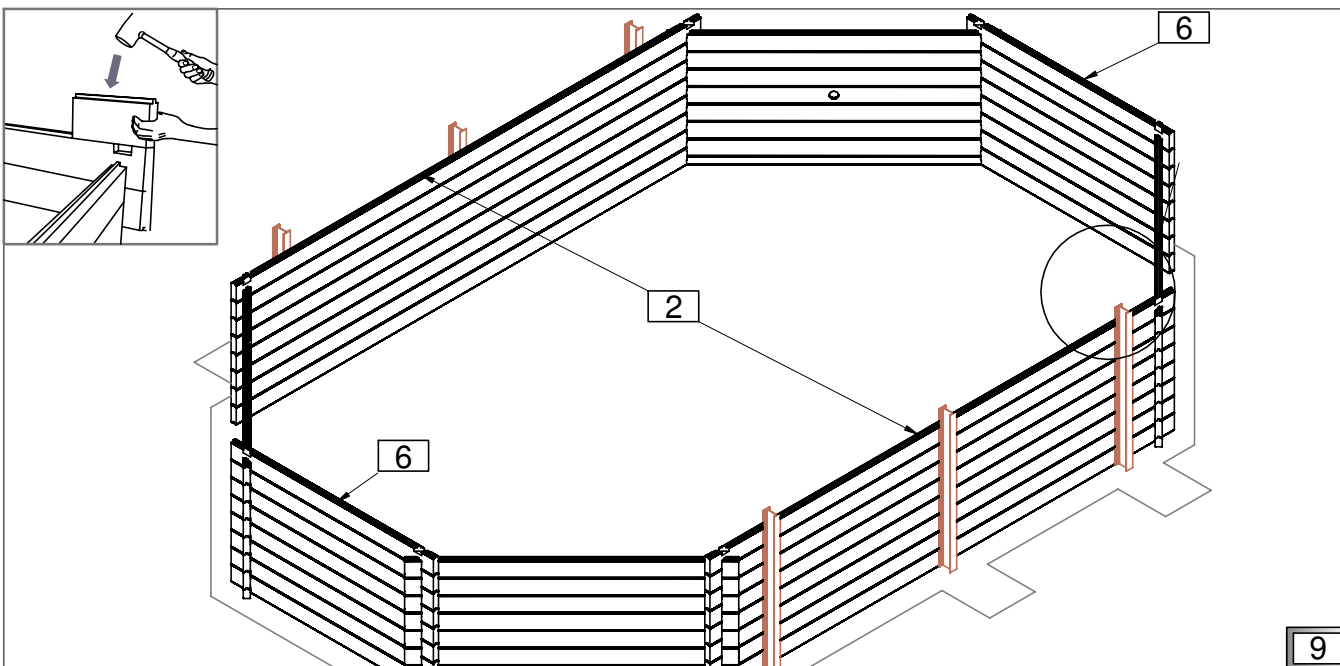

9



IX

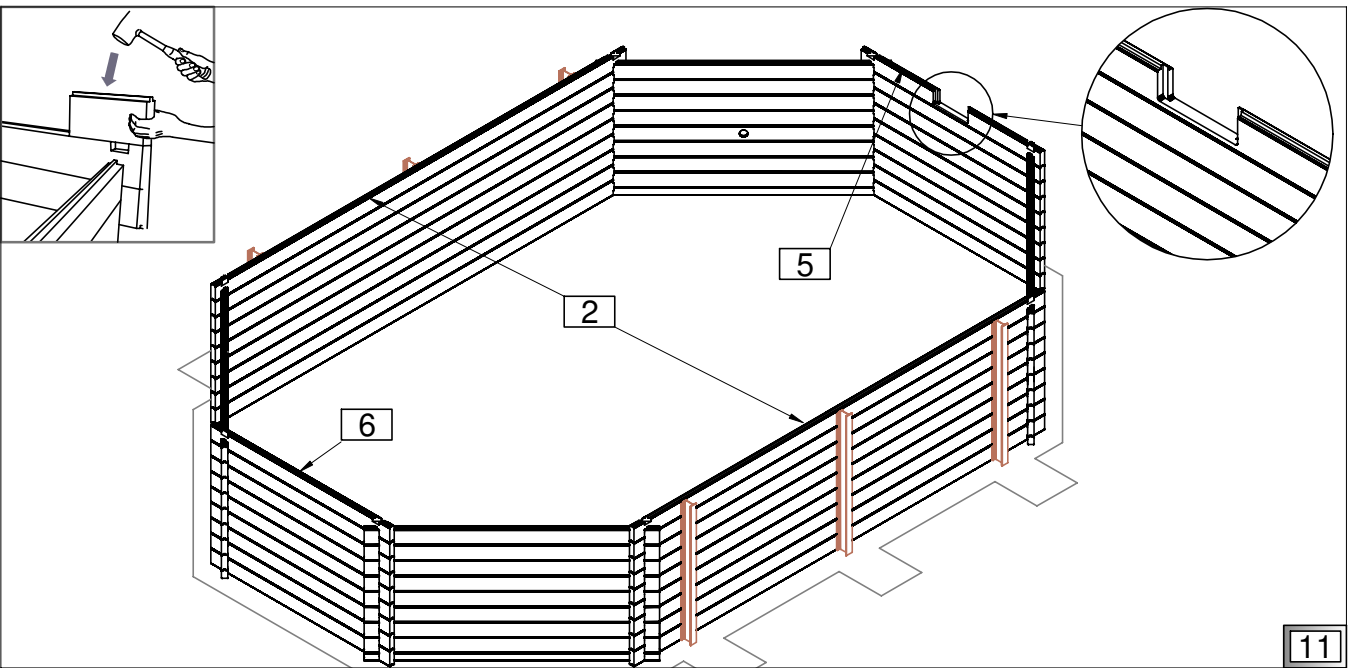
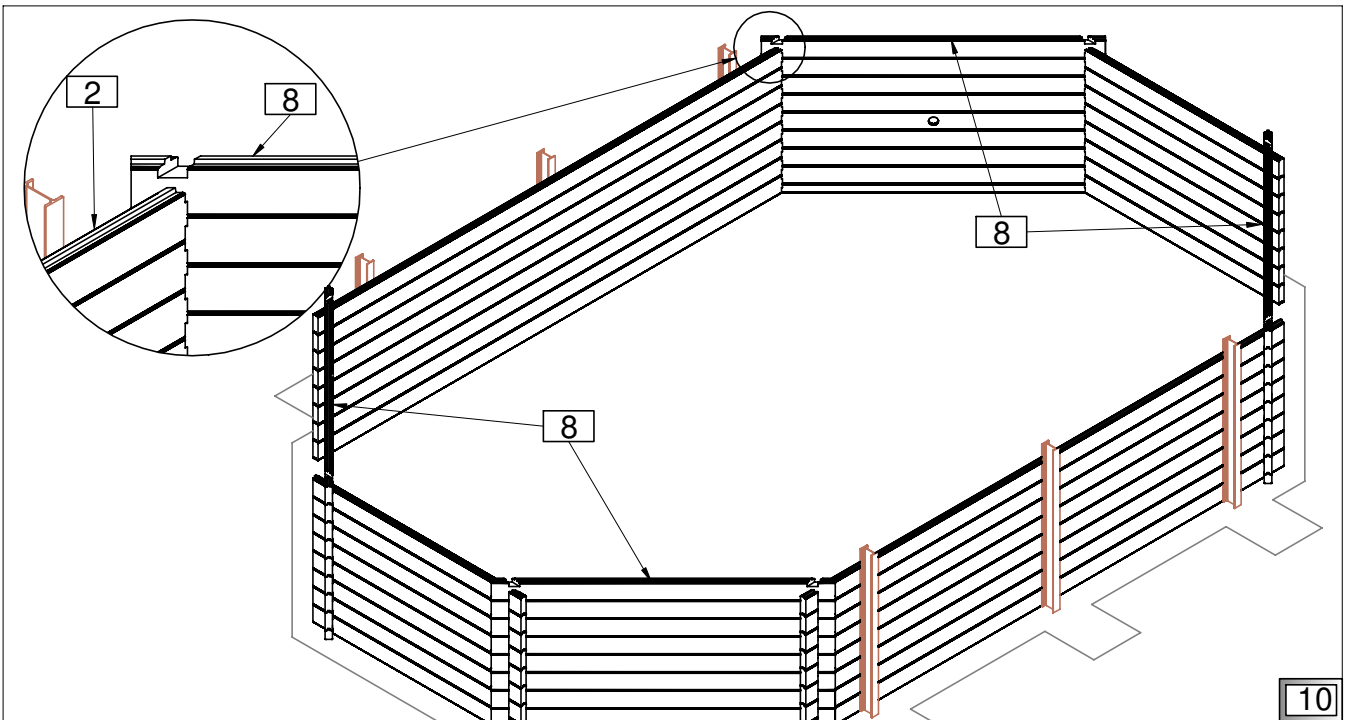
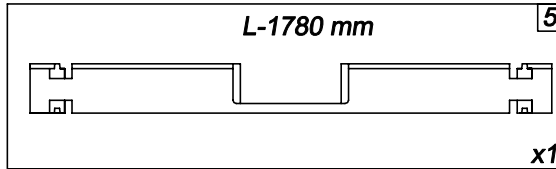
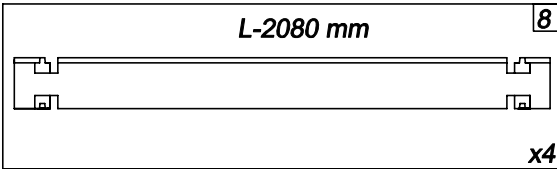
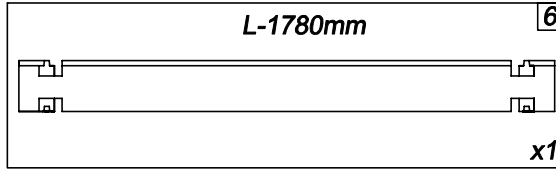
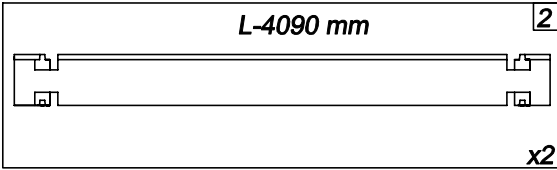

PL Skimmer

GB Skimmer

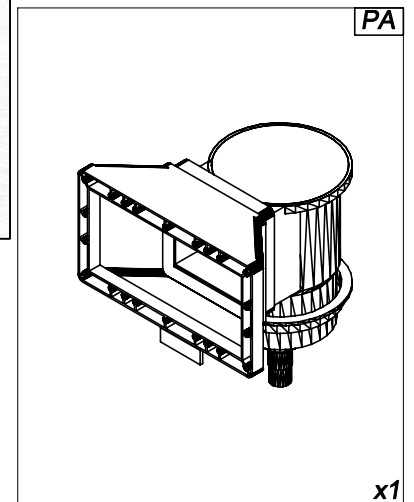
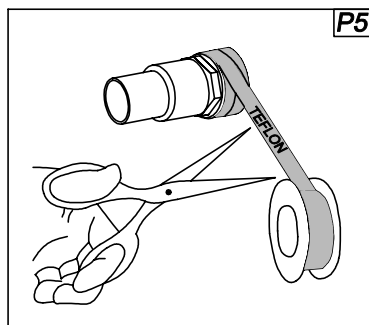
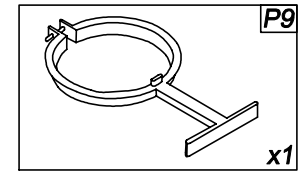
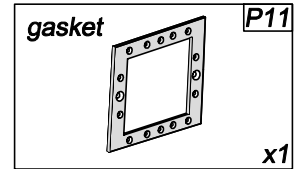
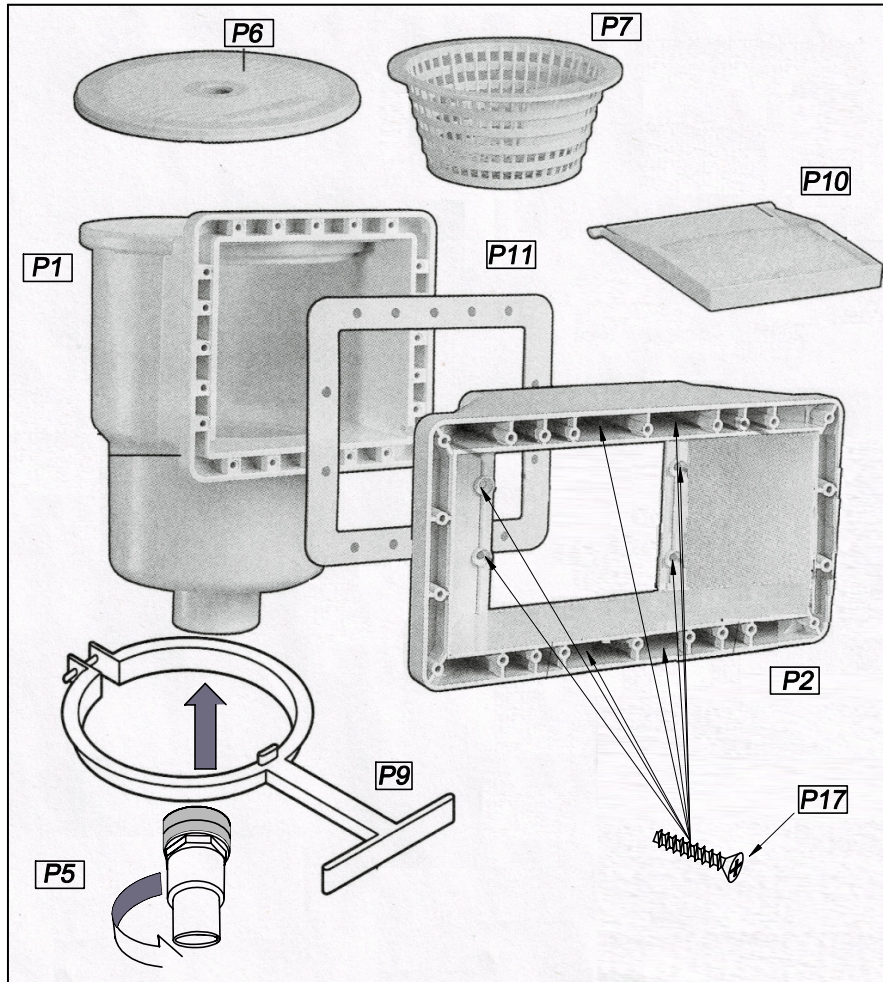
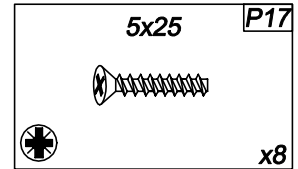
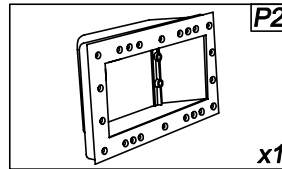
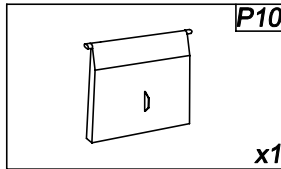
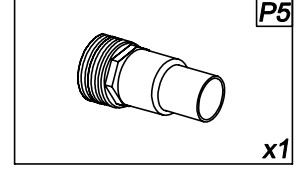
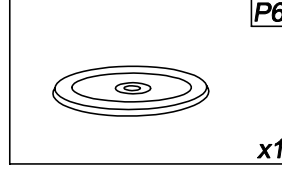
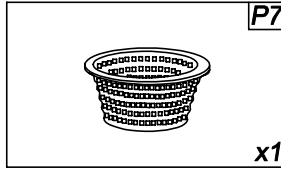
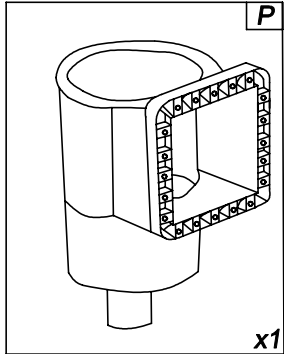

PL Struktura drewniana

GB Wooden structure

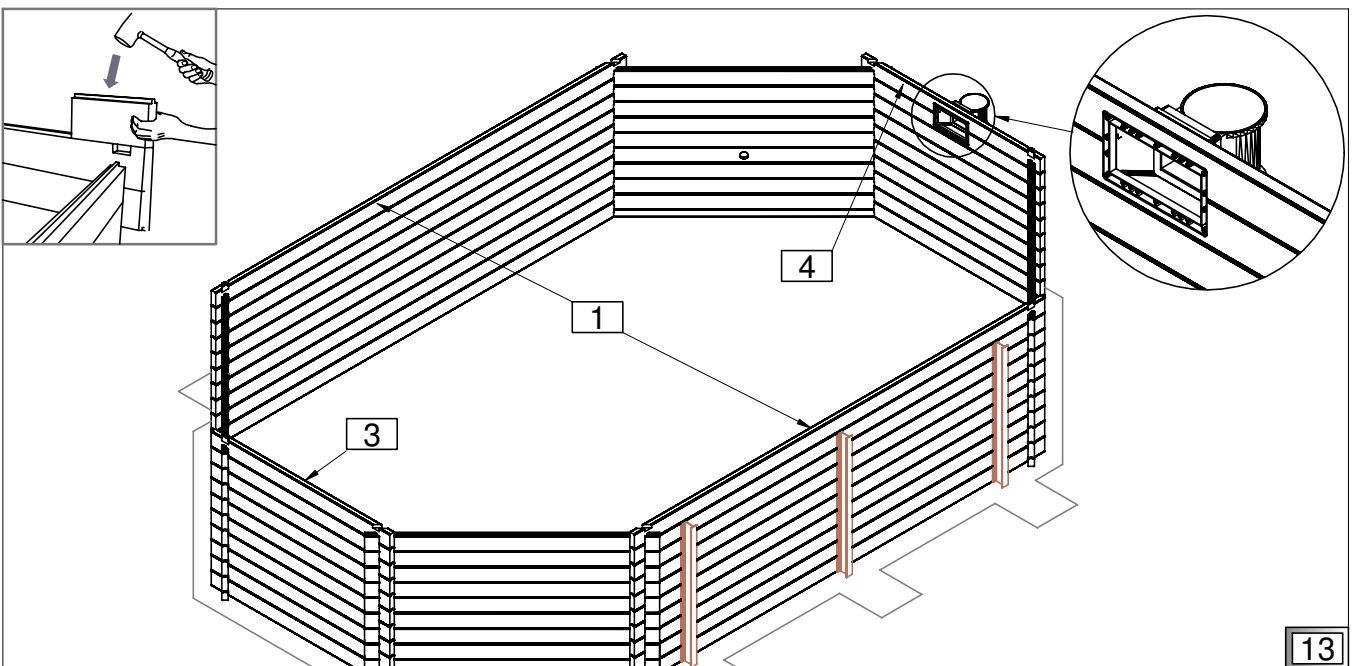
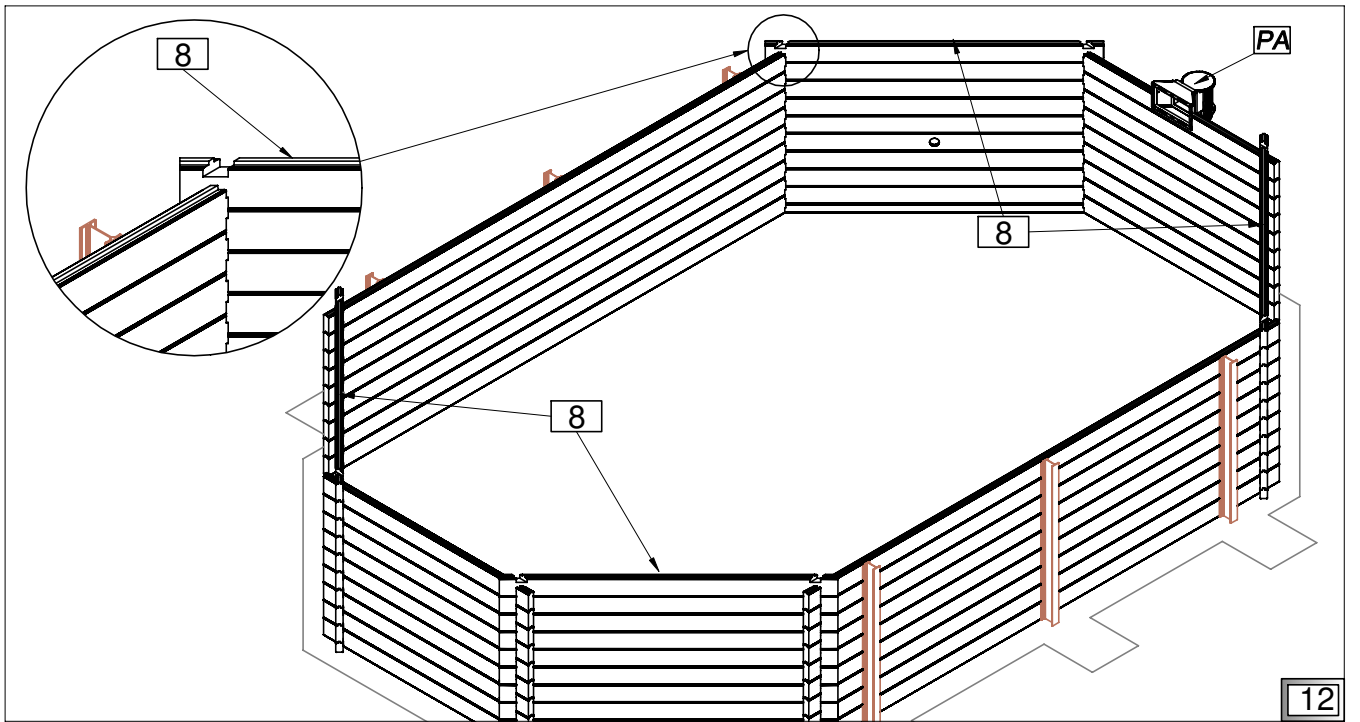
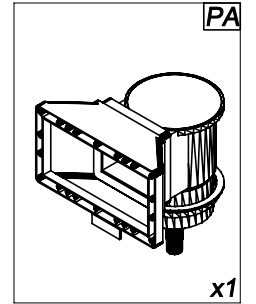
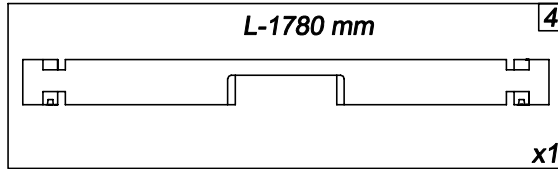
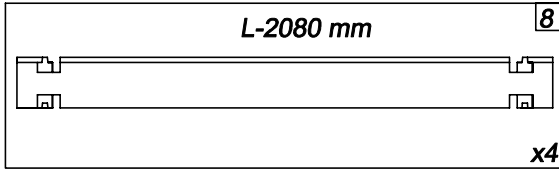
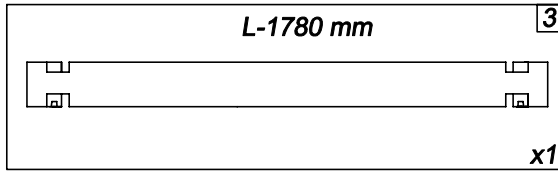
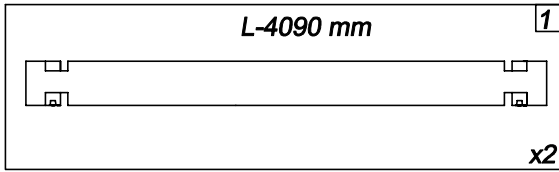



XI

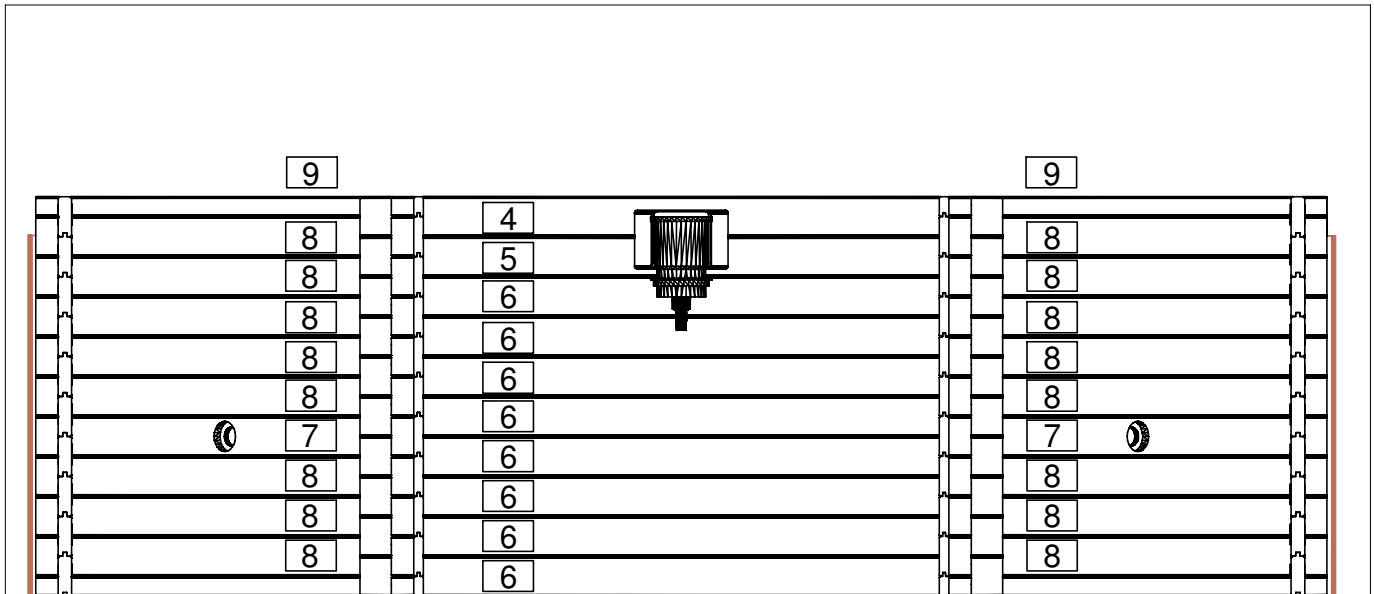
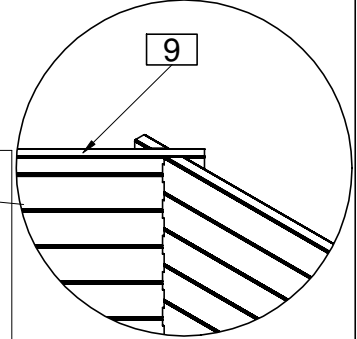
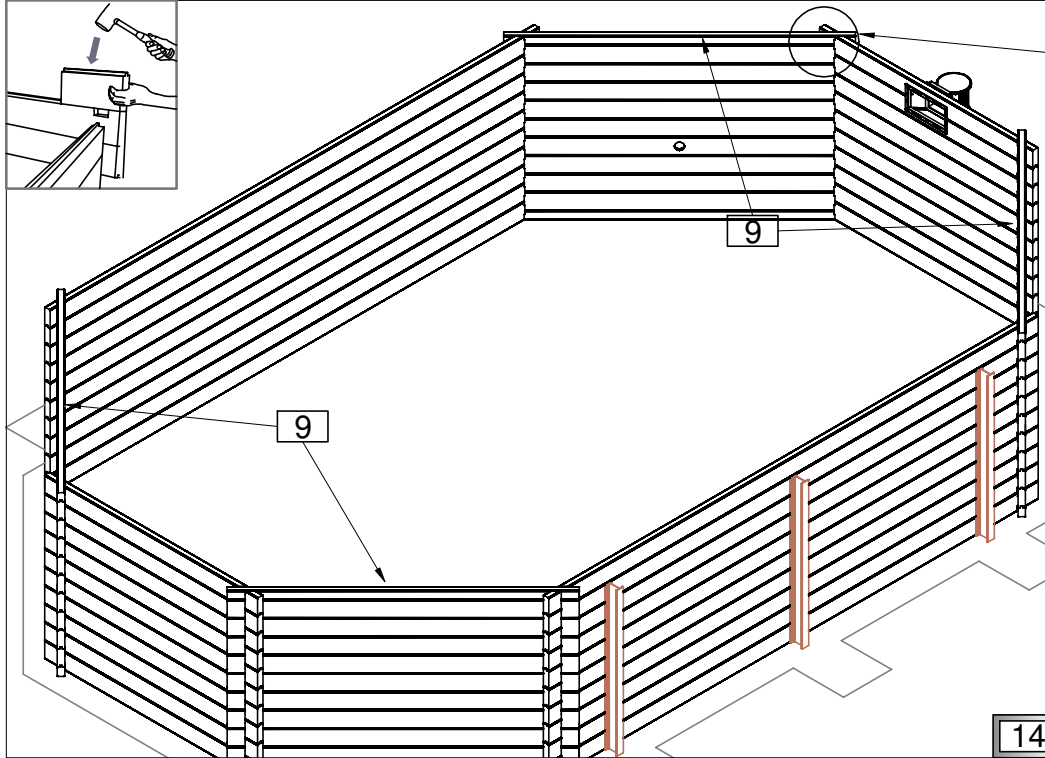
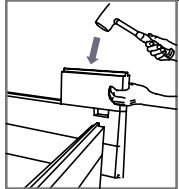
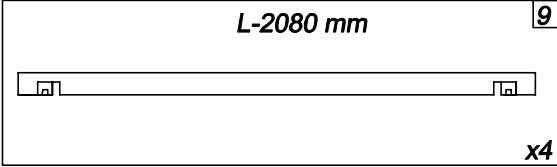

15

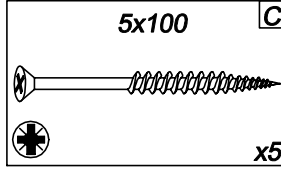
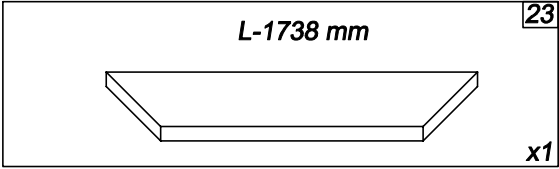

XI

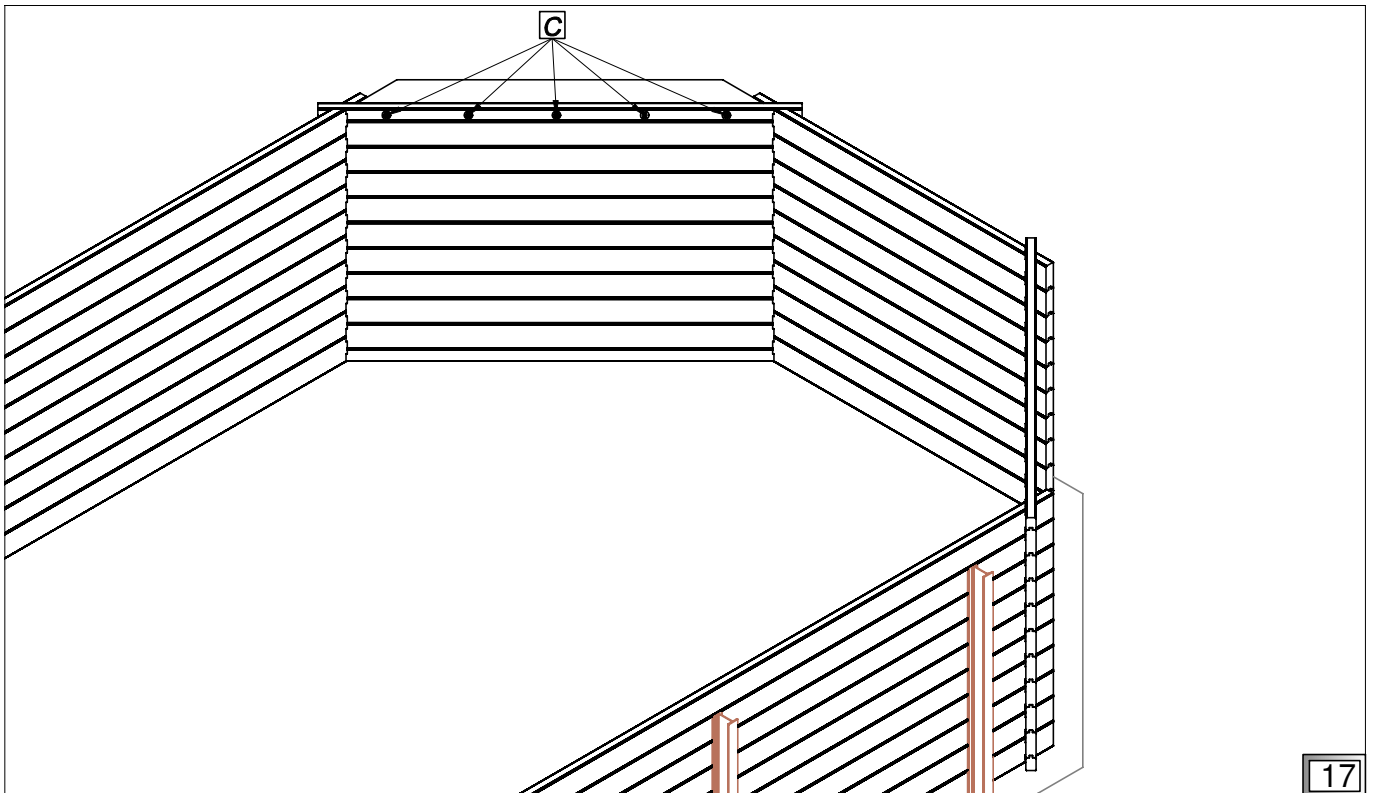
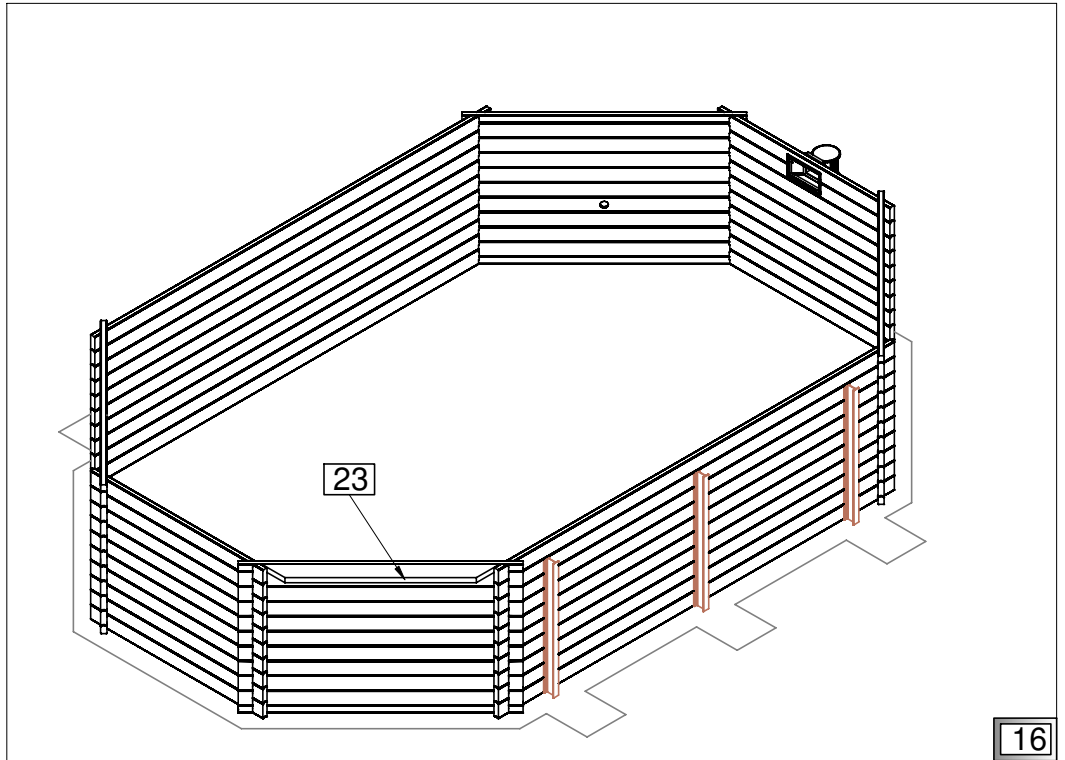

PL Struktura drewniana

GB Wooden structure

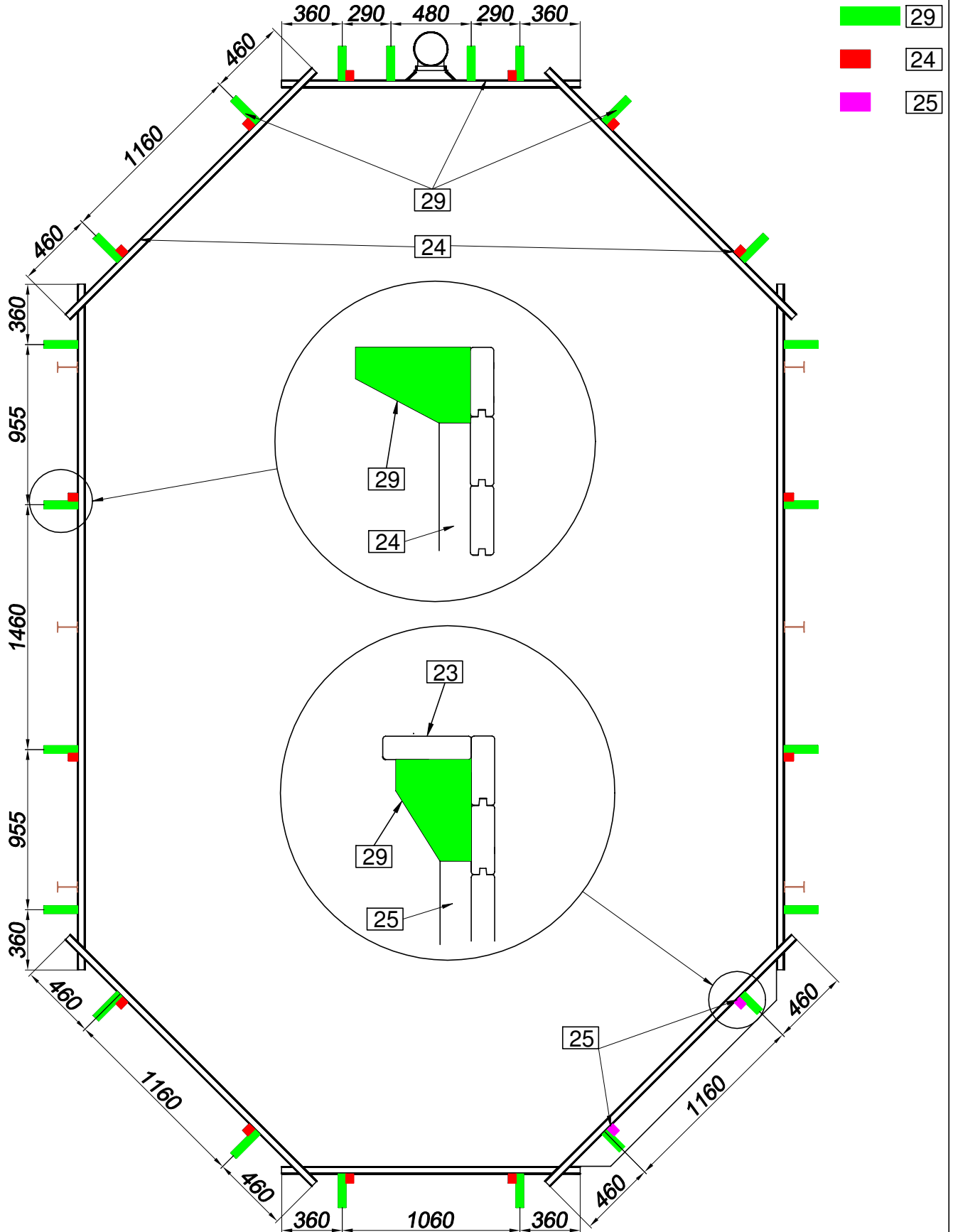

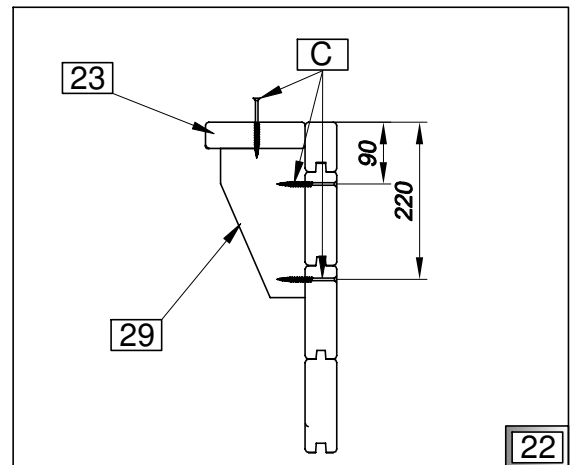
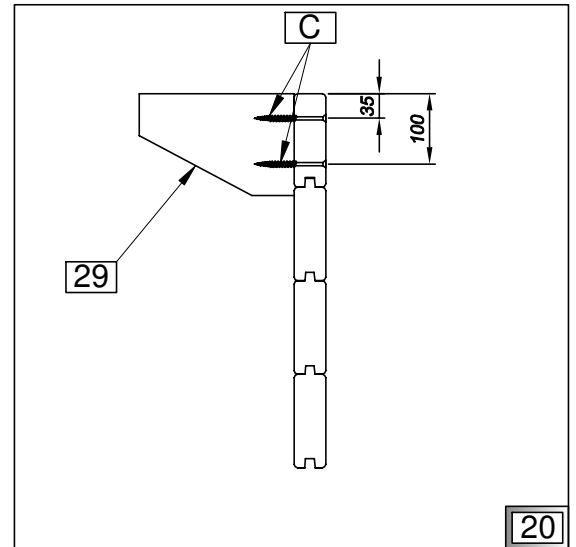
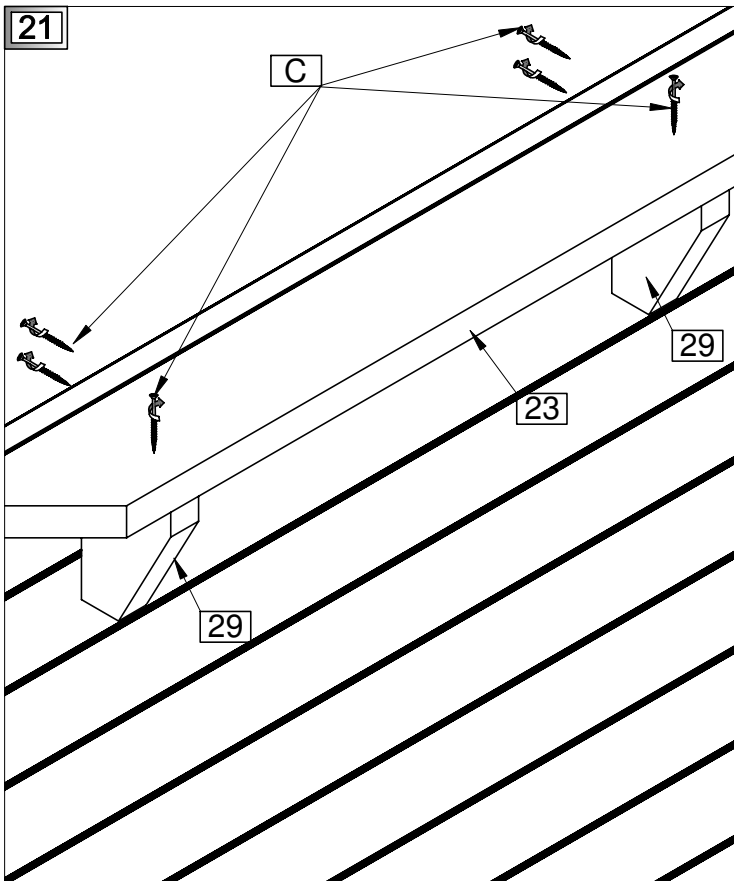
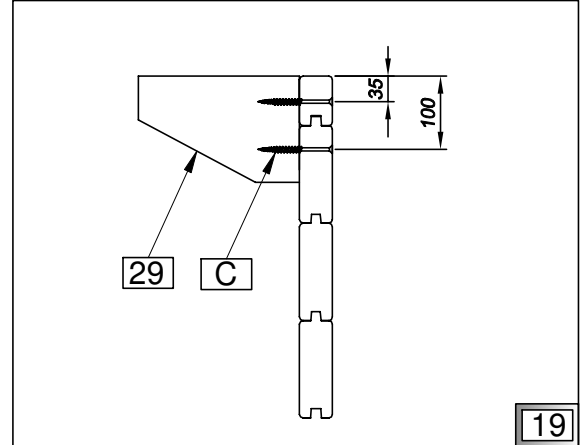
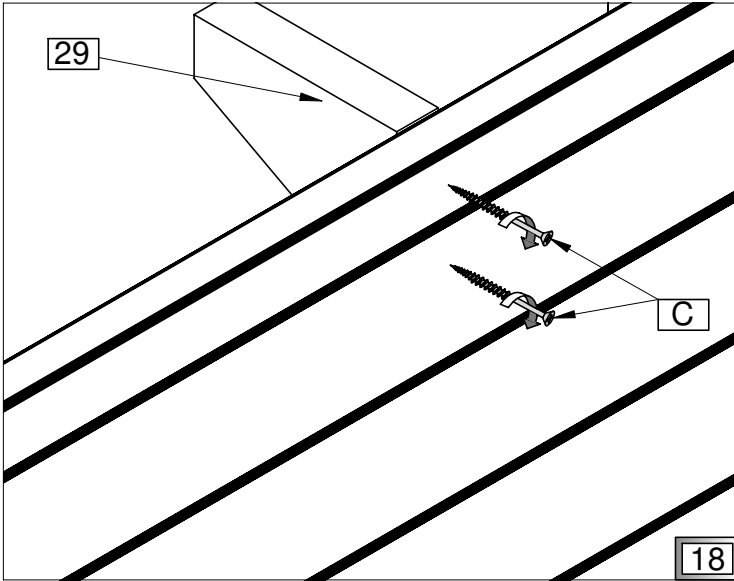
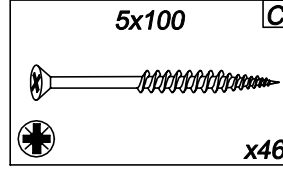
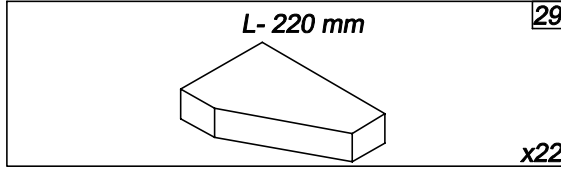

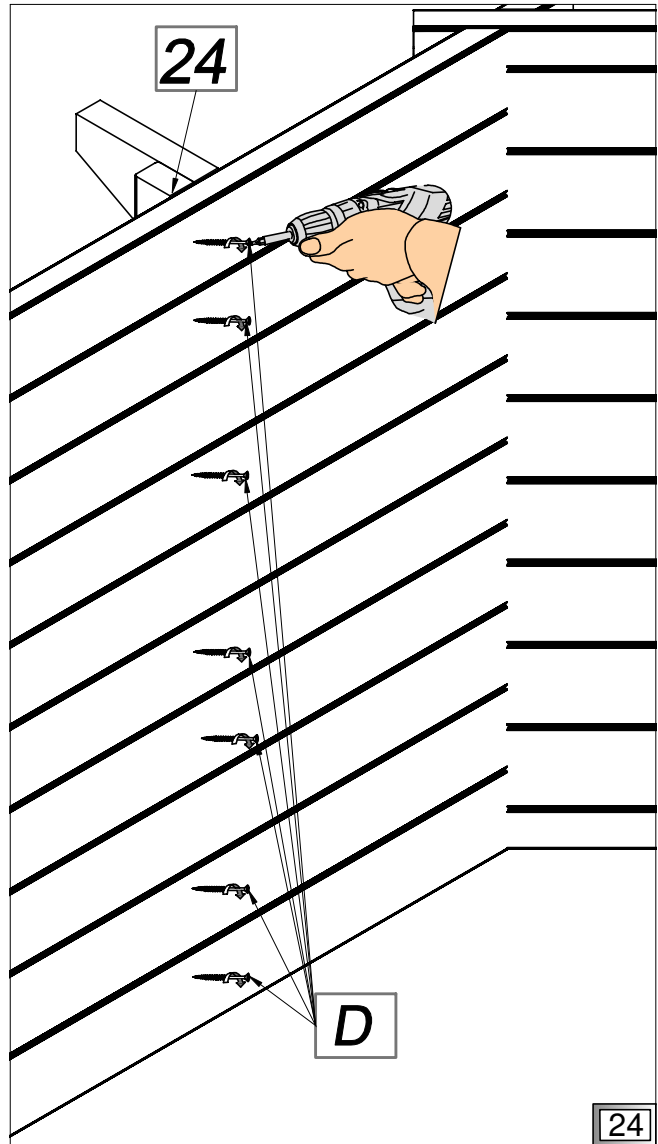
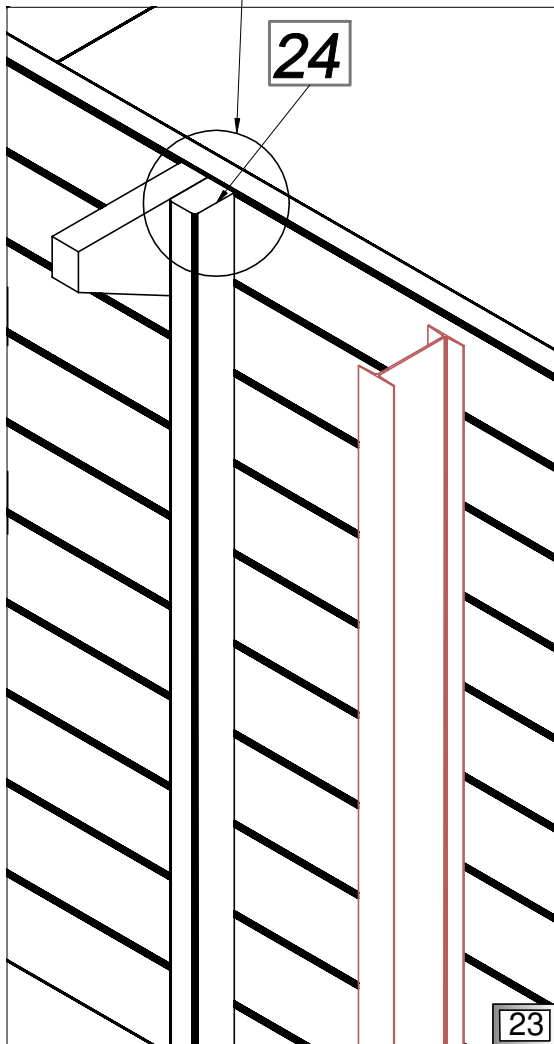
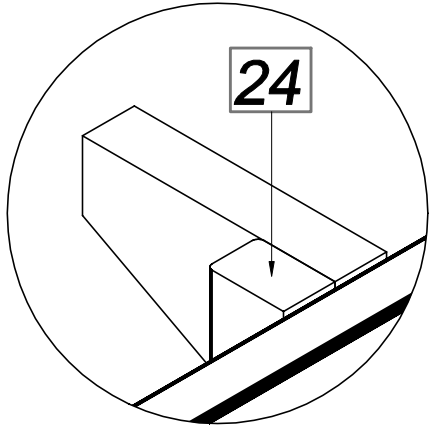
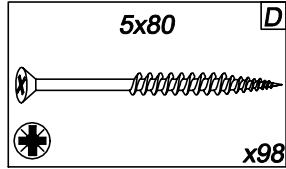
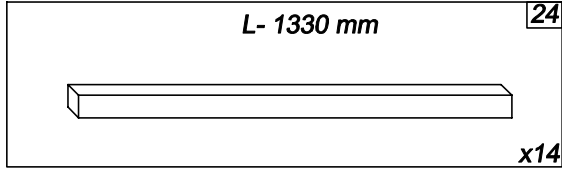

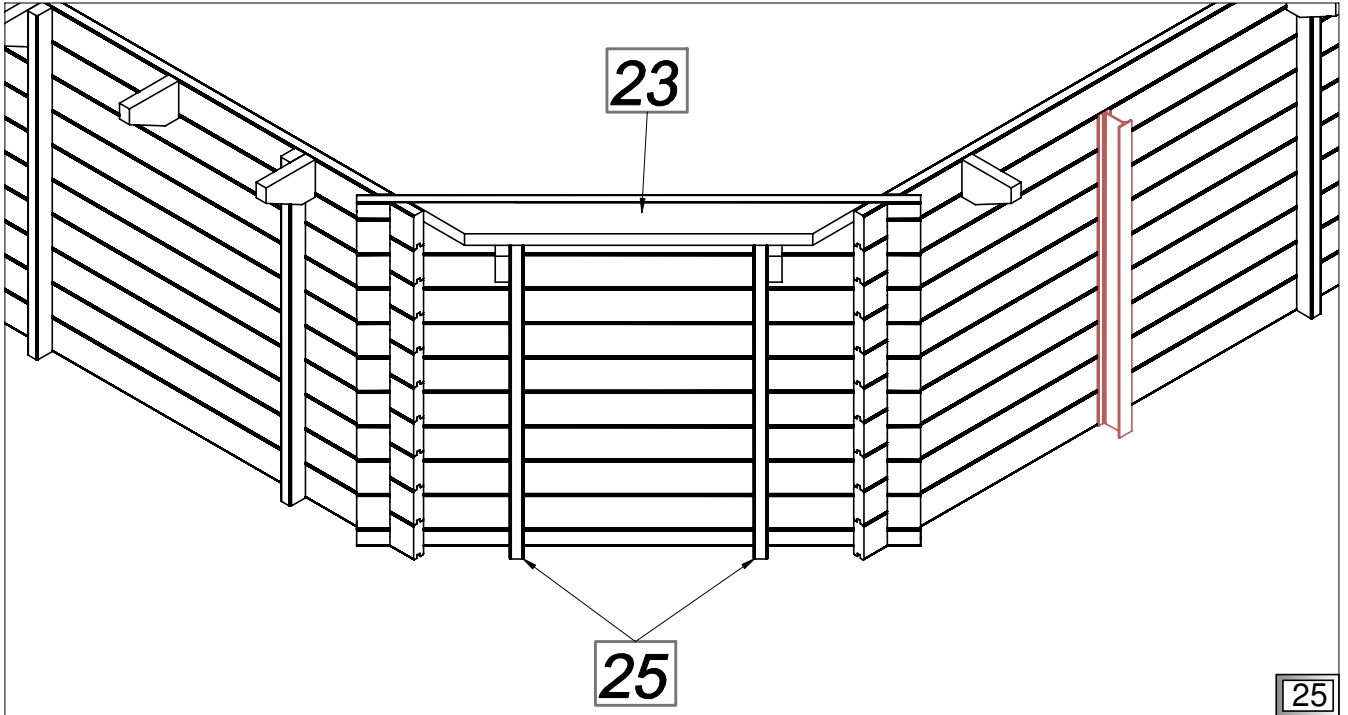
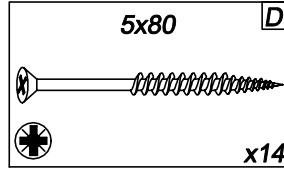
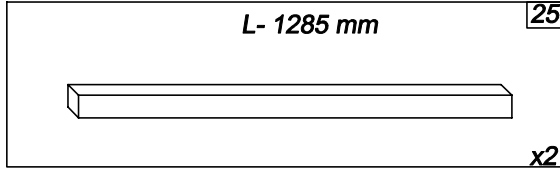

25

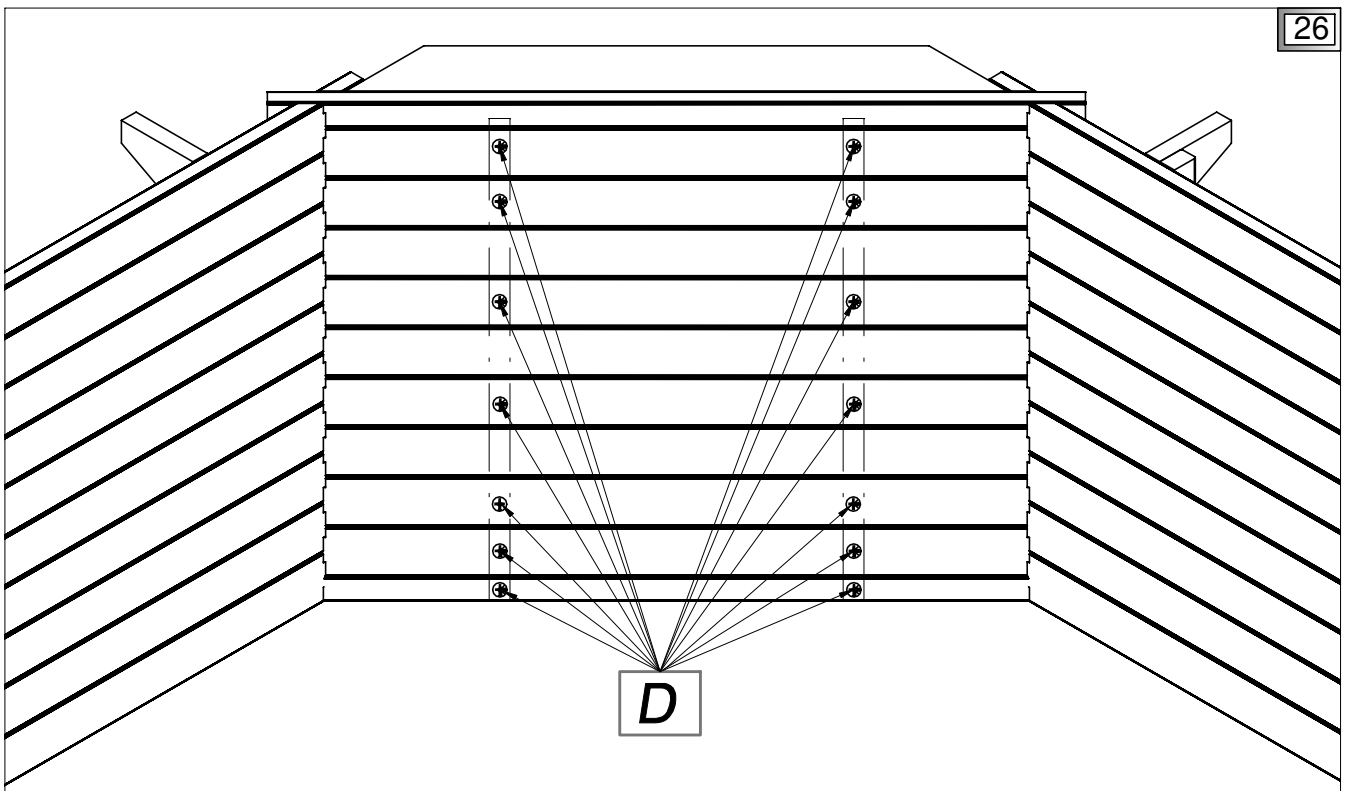

26

D

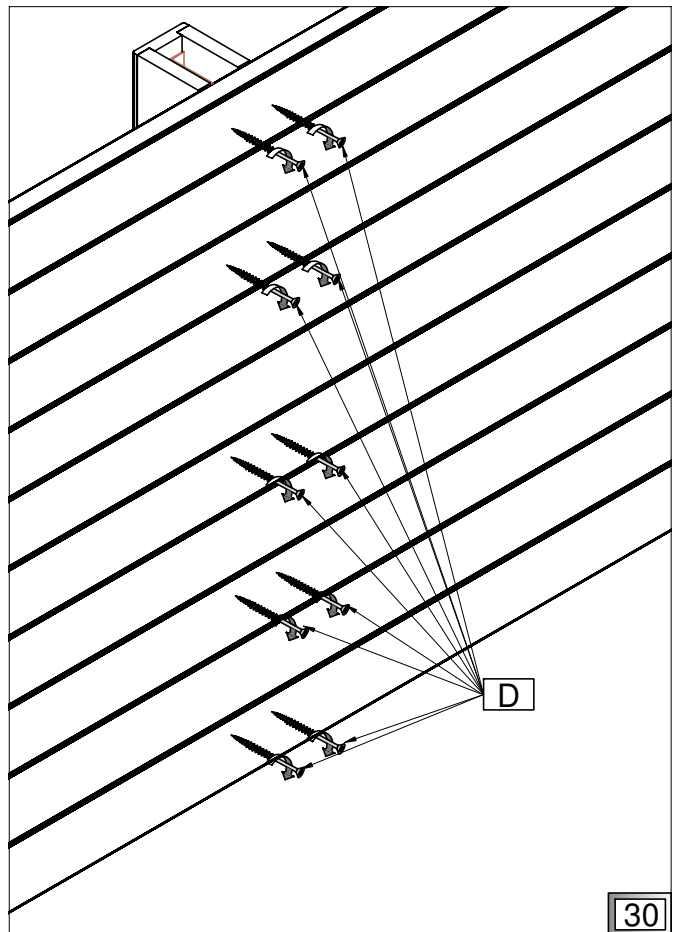
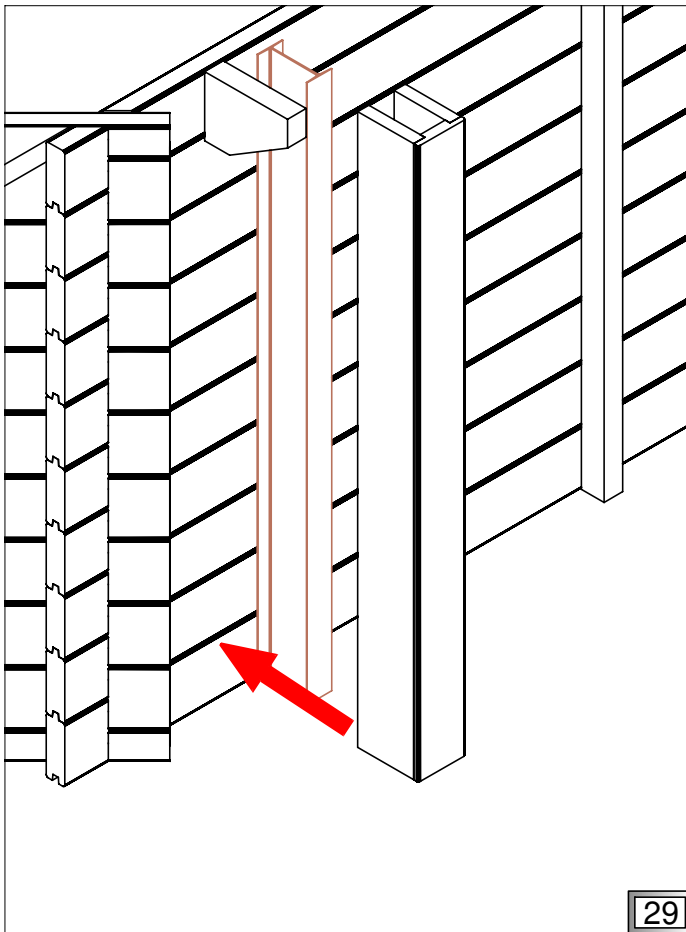
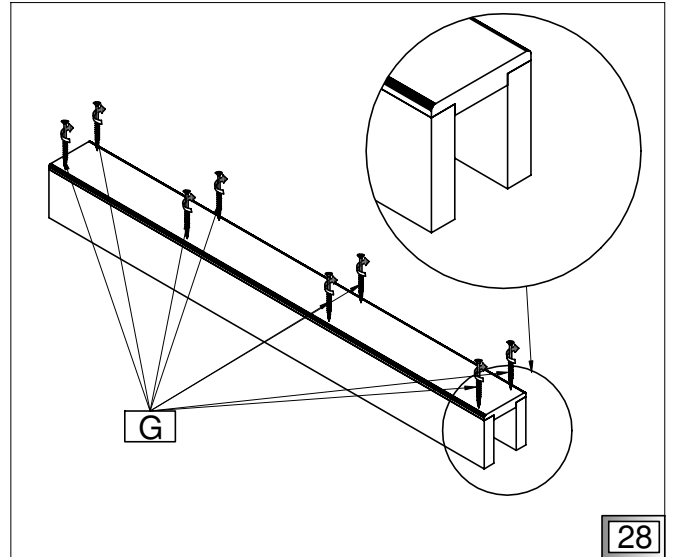
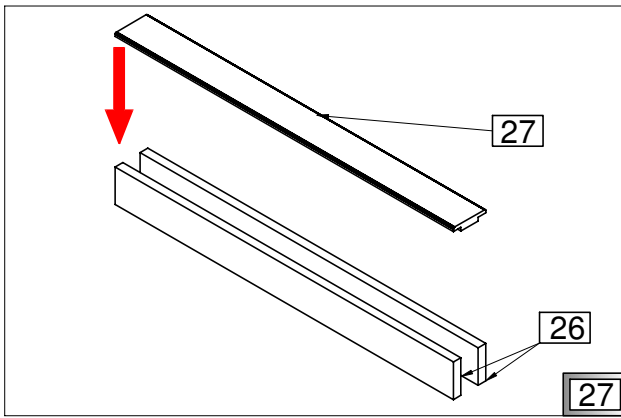
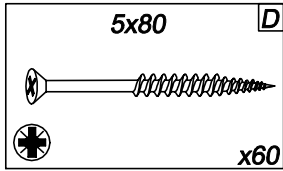
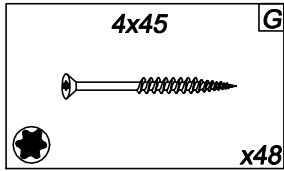
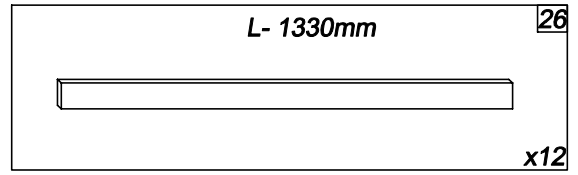
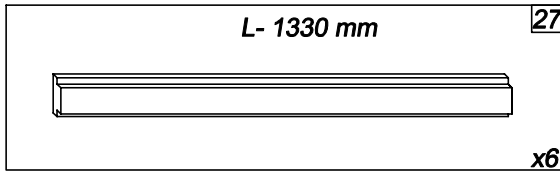

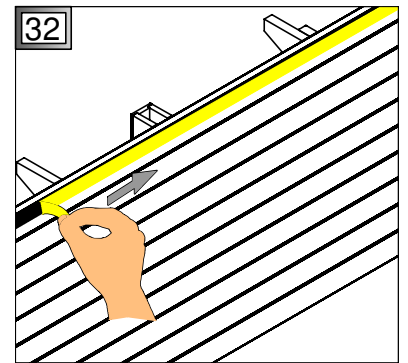
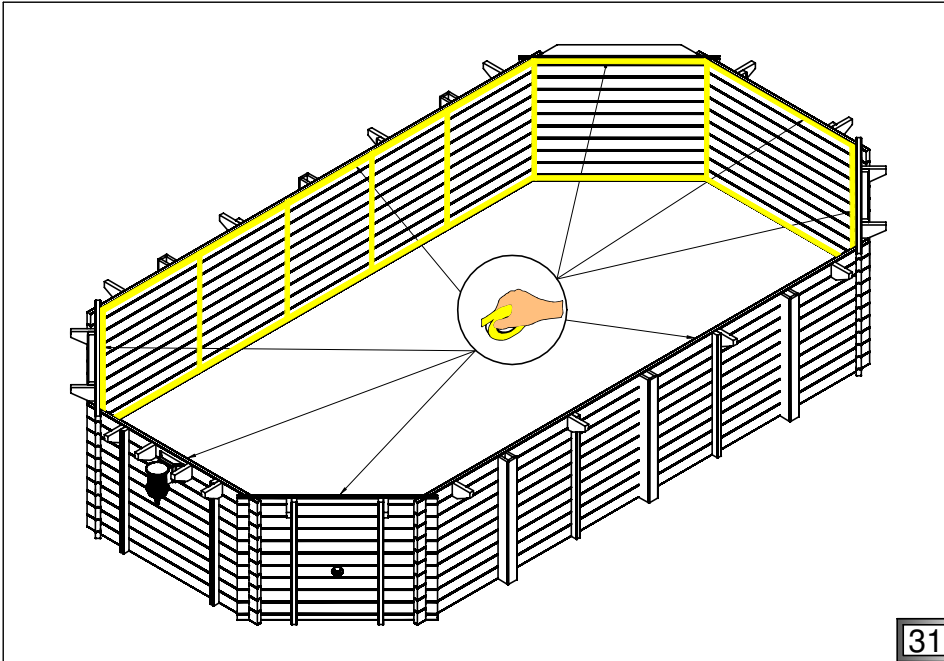
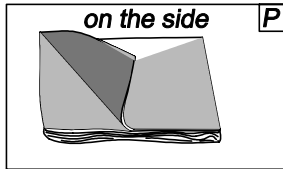

31

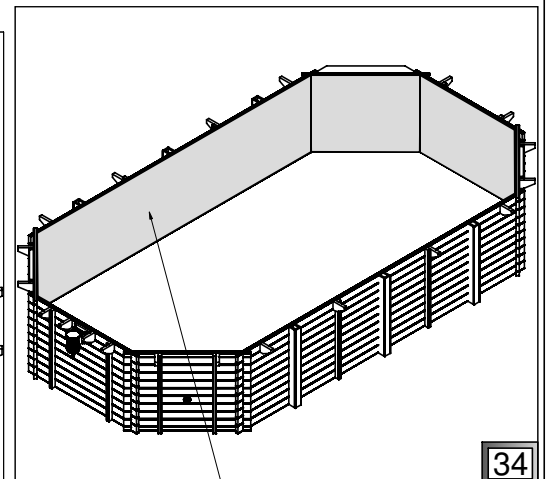
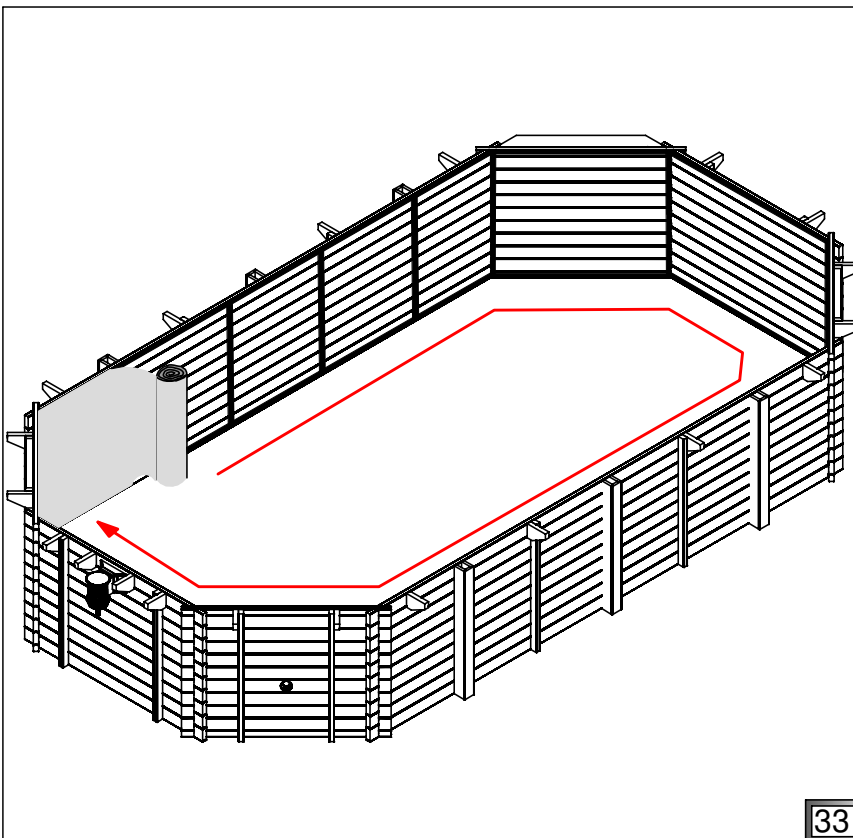

34

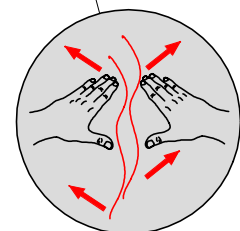

33

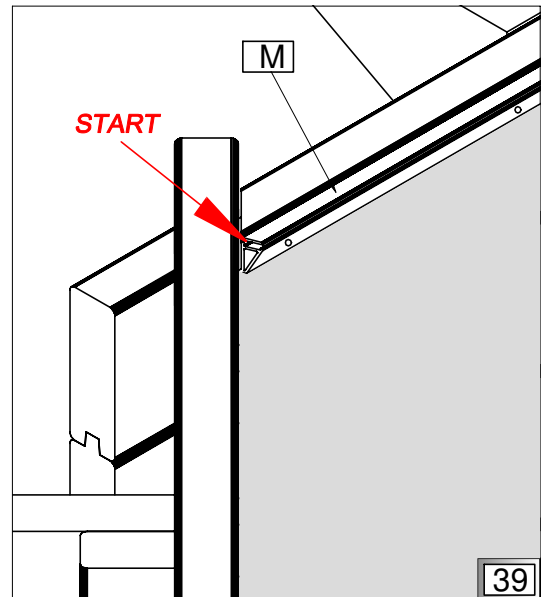
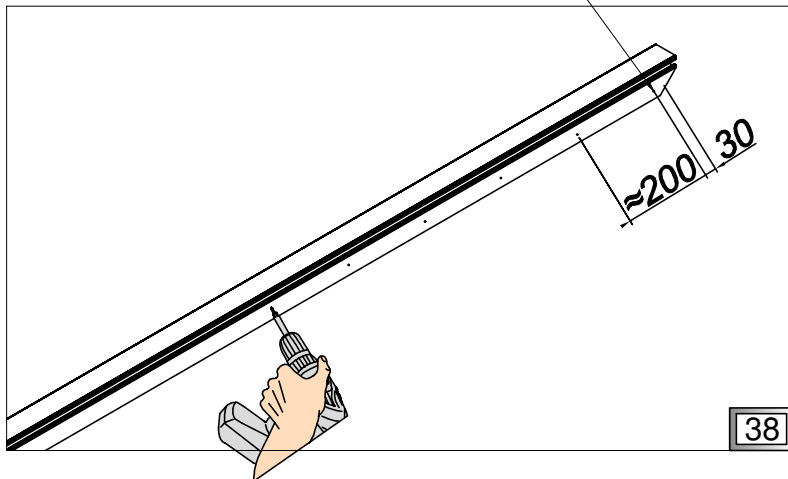
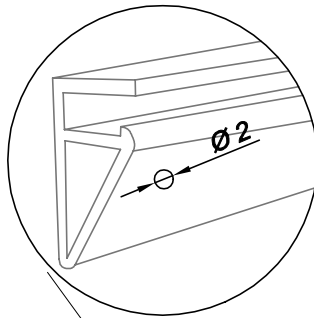
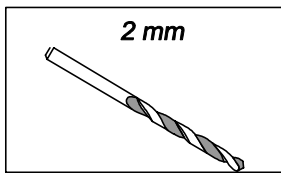
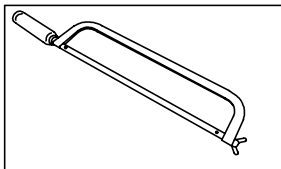
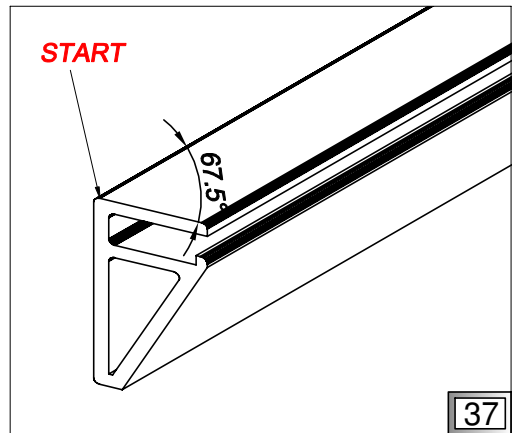
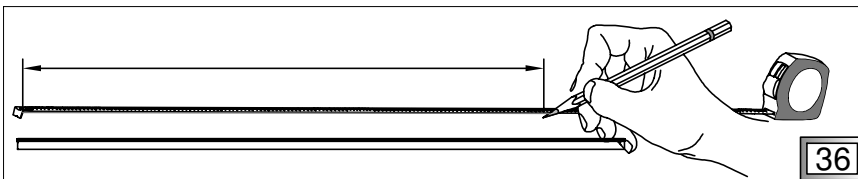
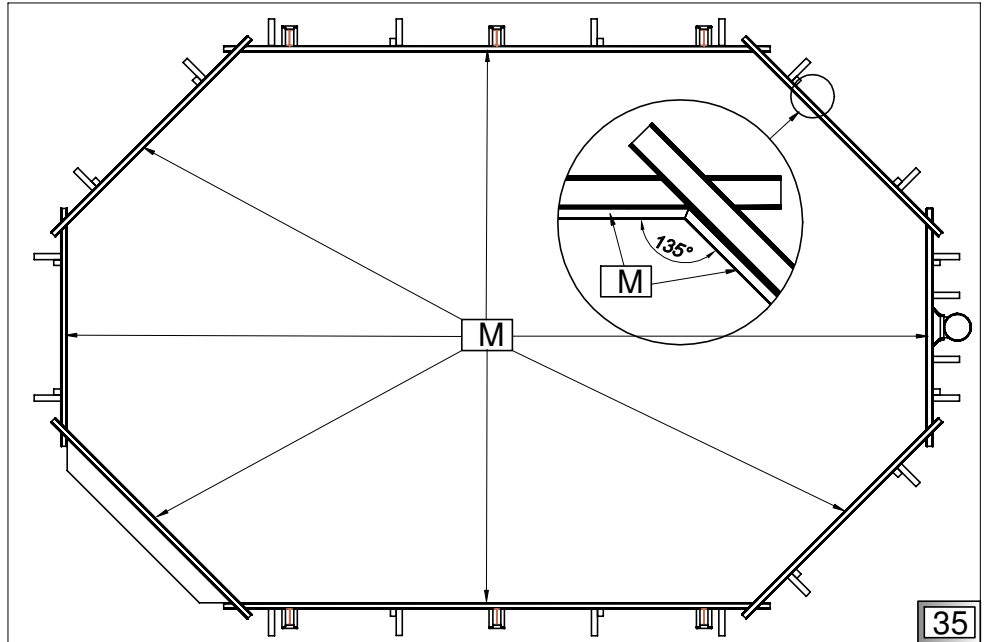
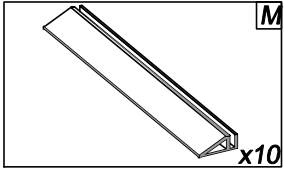

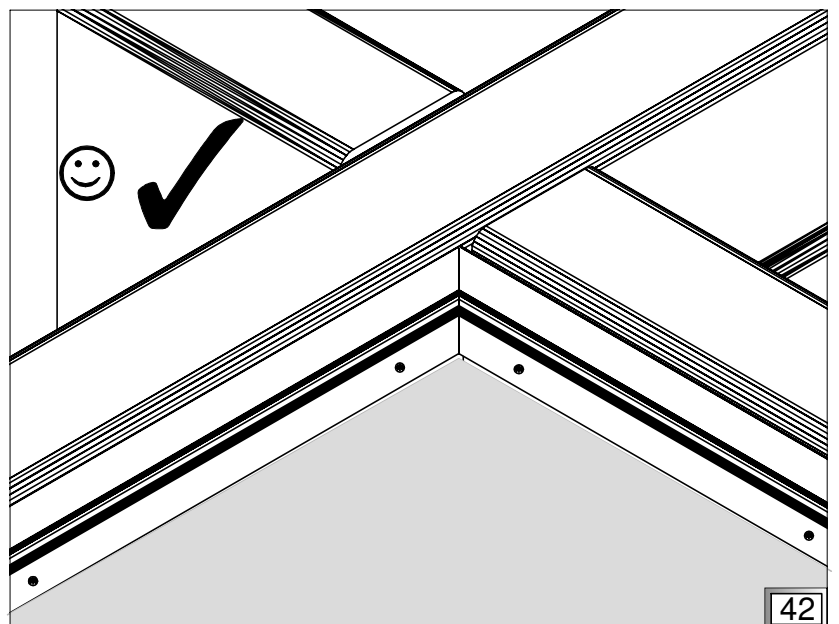
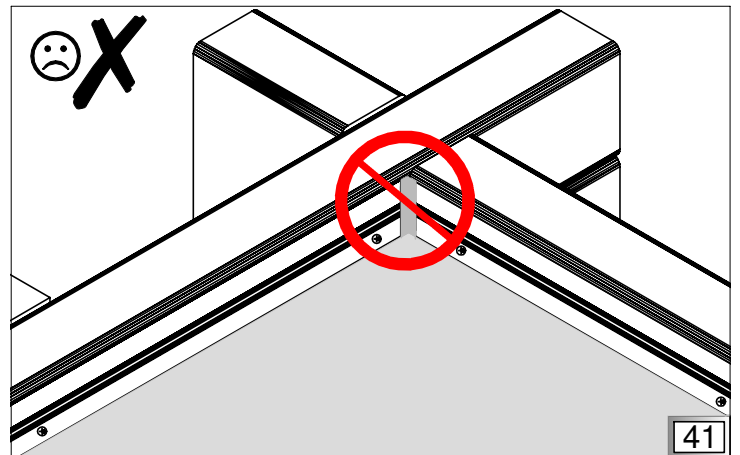
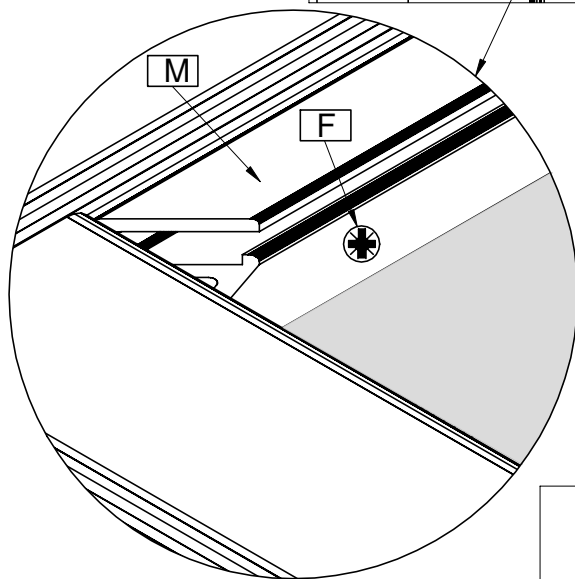
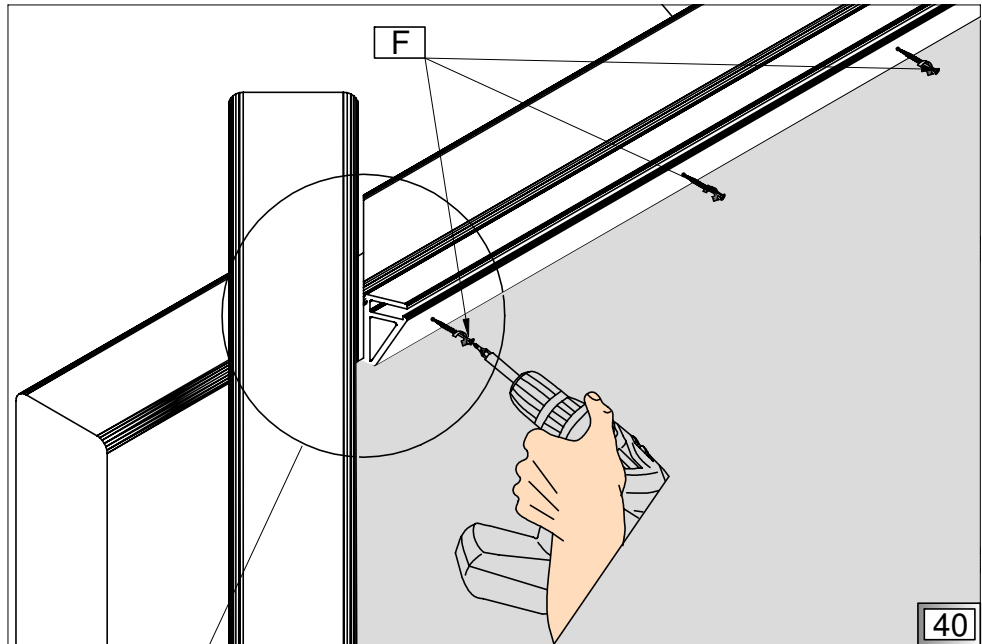
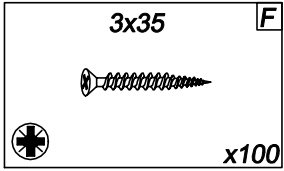

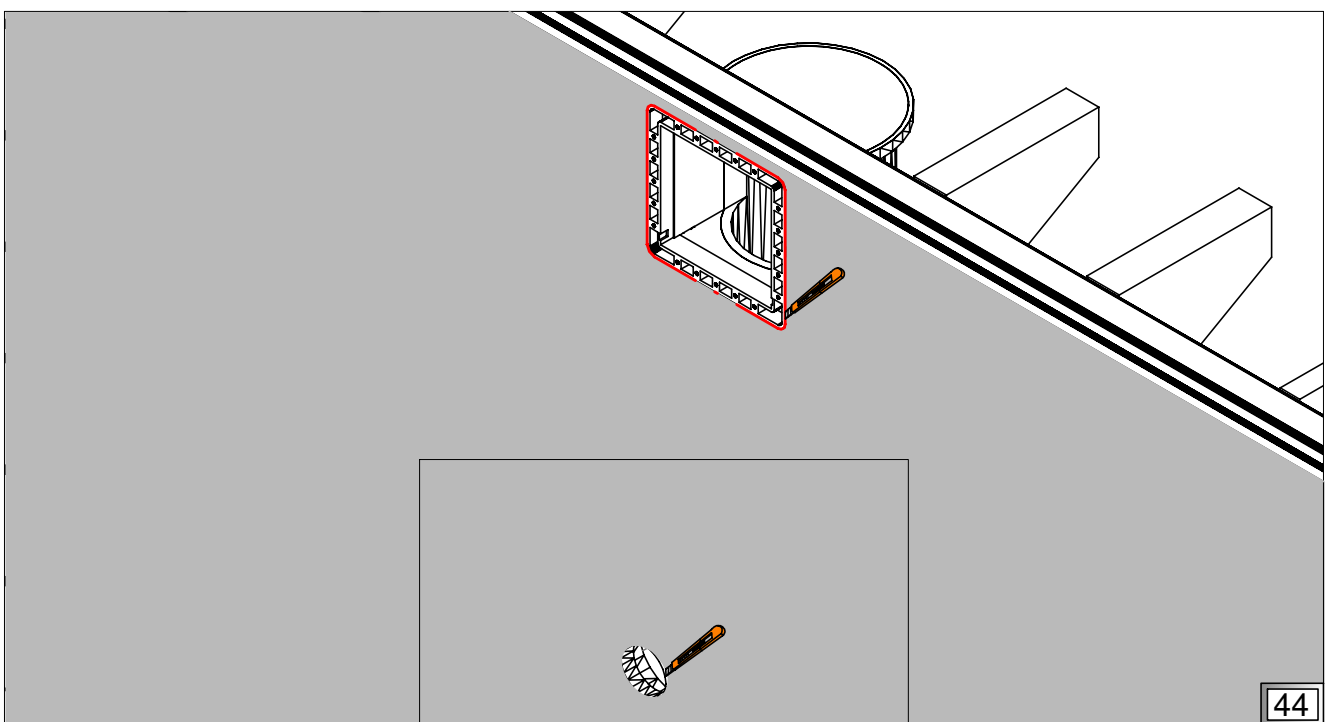
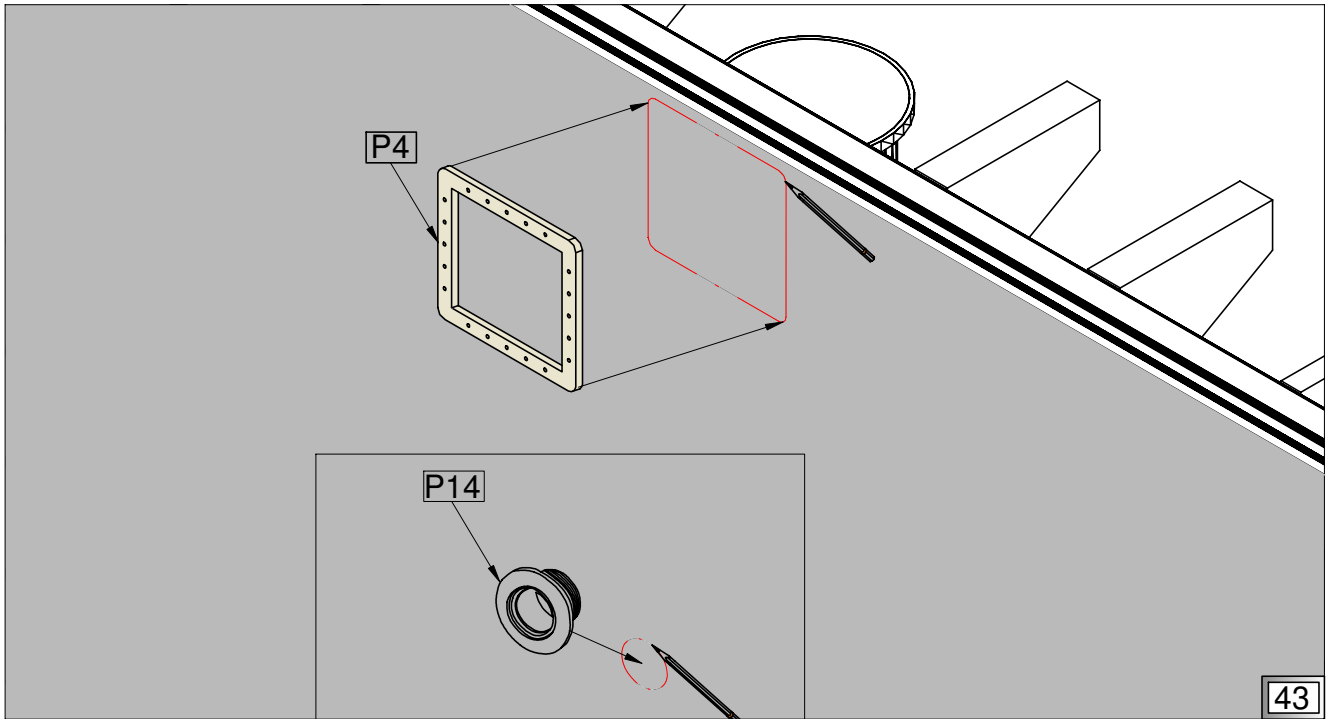
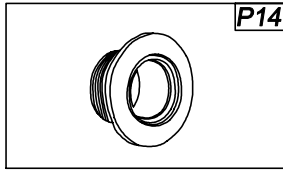
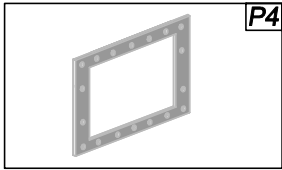

PL Geotextil

GB Geotextile



to the bottom

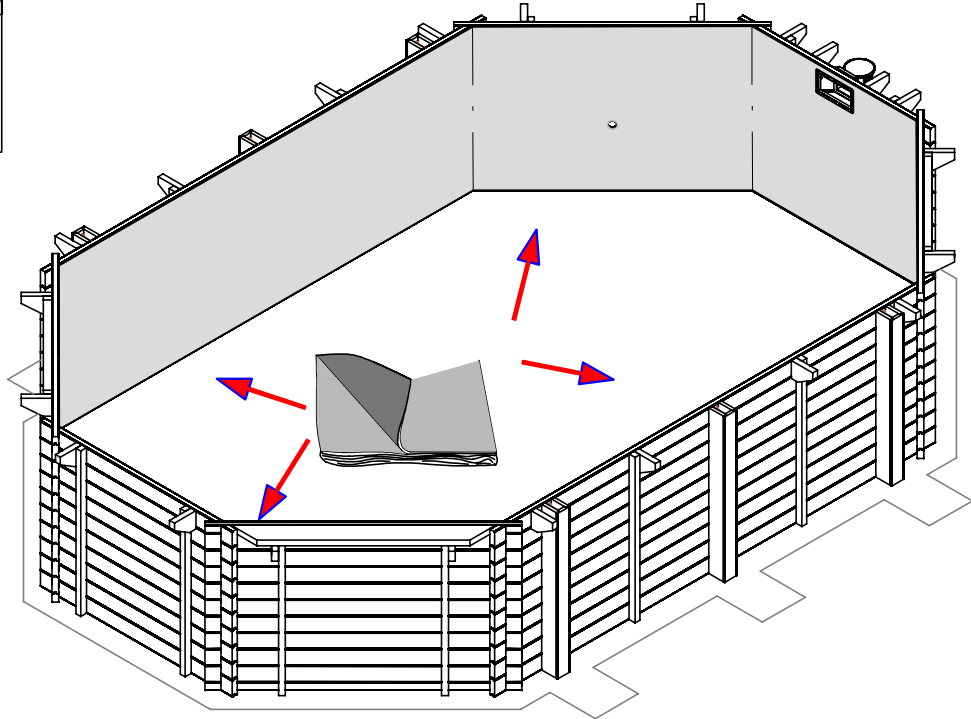
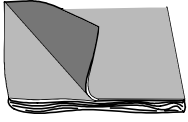

45

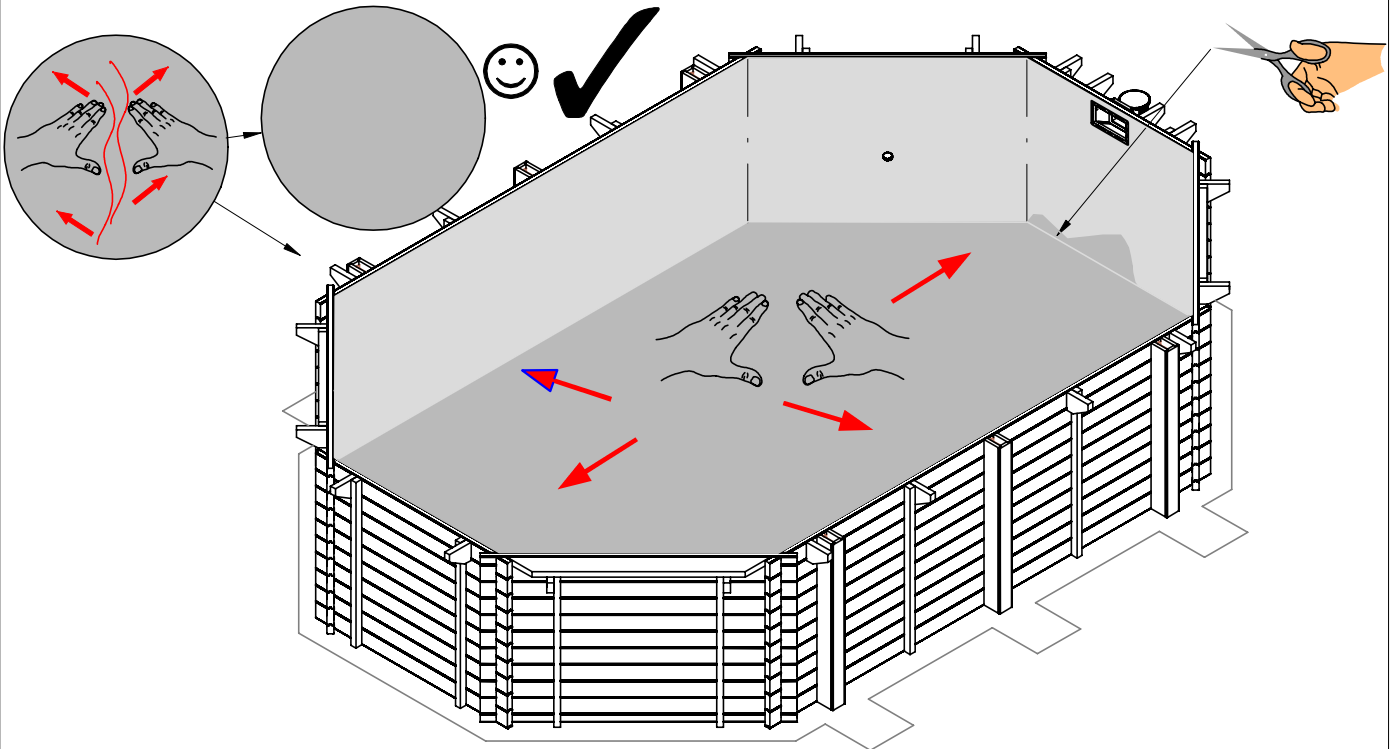

46

PL Liner

GB Liner

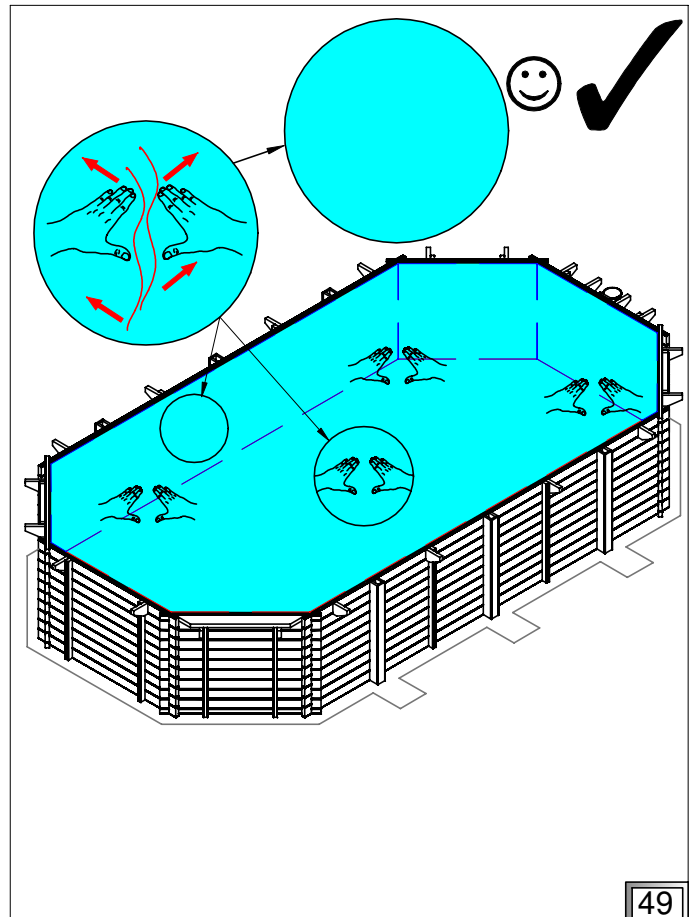
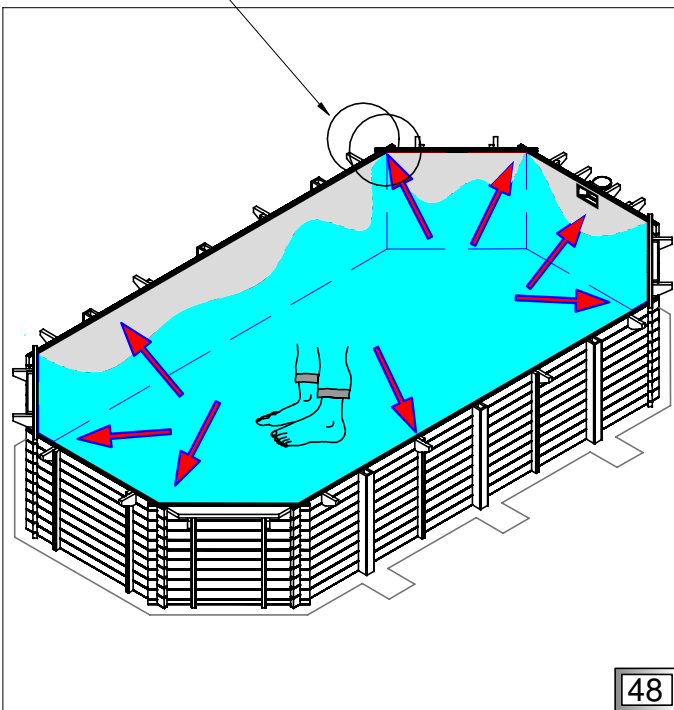
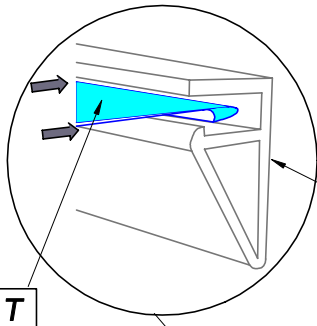
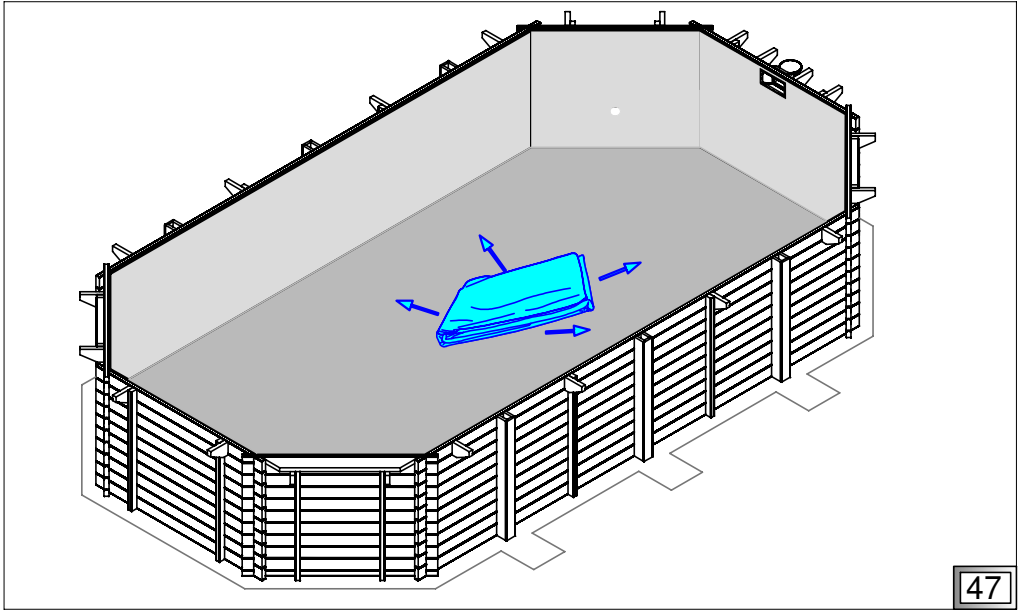
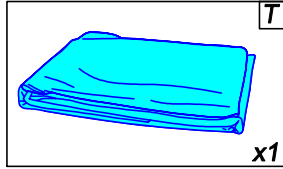
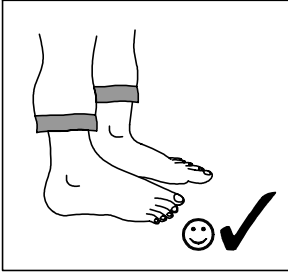
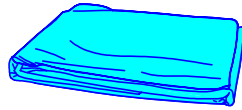

PL Liner

GB Liner

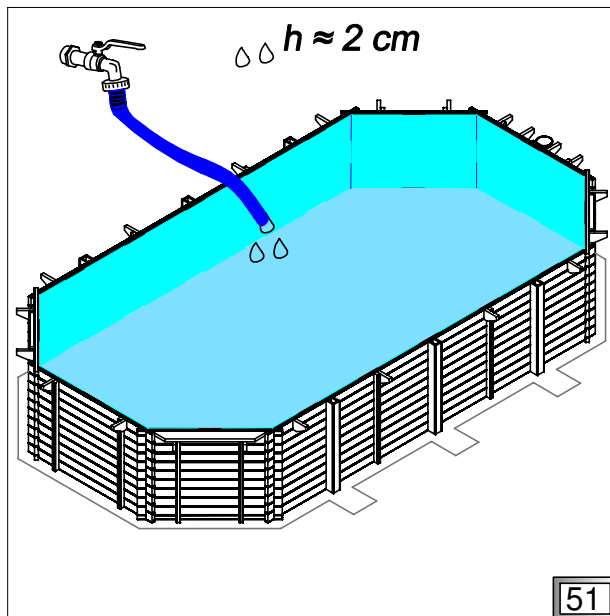
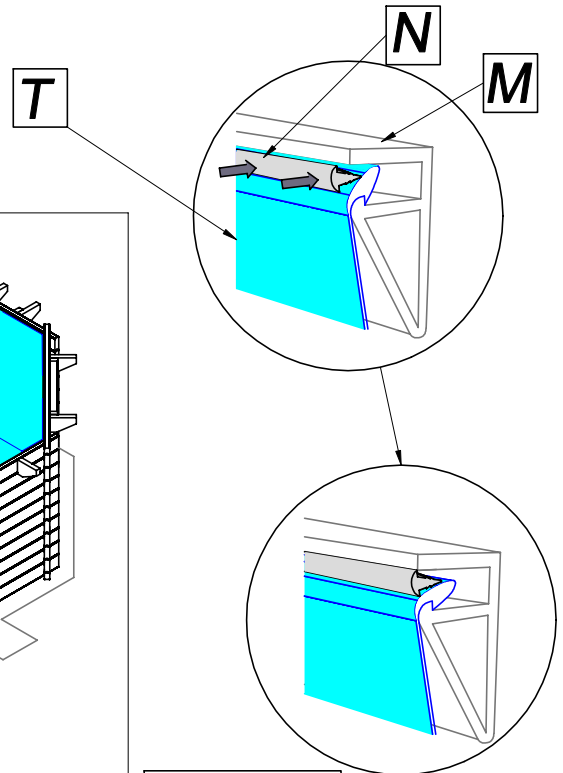
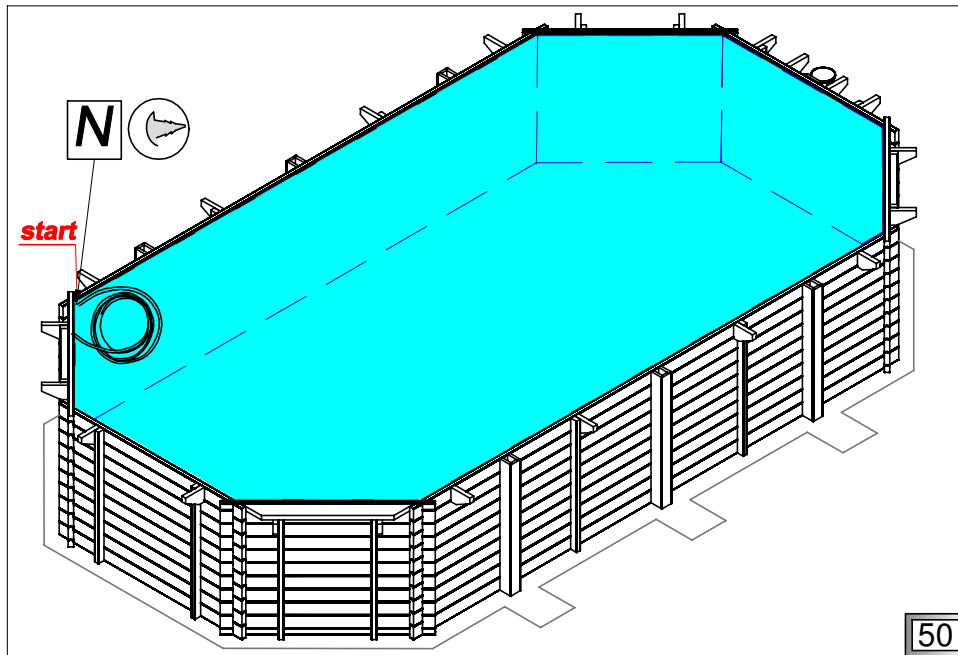
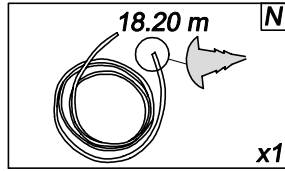
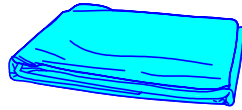

PL Wyrównaj sfaldowania po nalaniu wody.

GB Smooth all folds after pouring water.

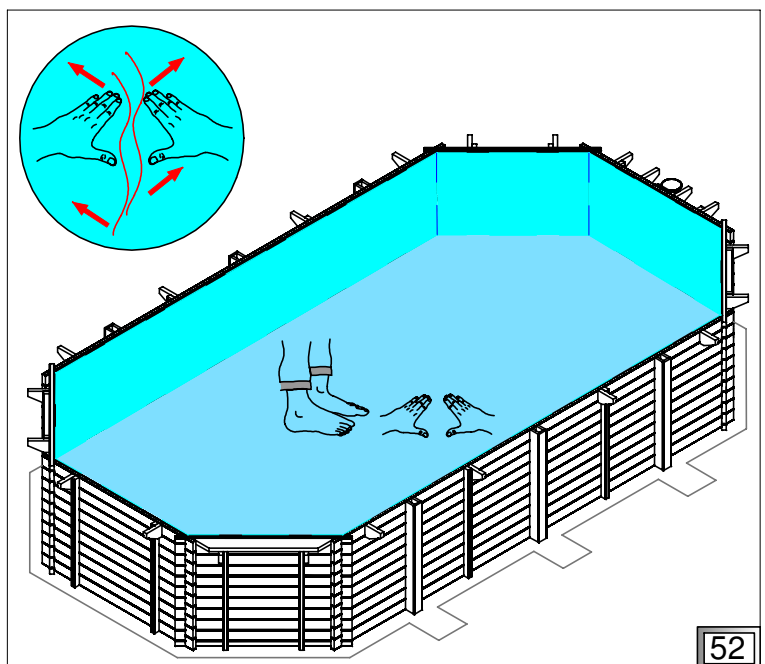
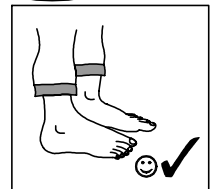

PL Dysze

GB Nozzles

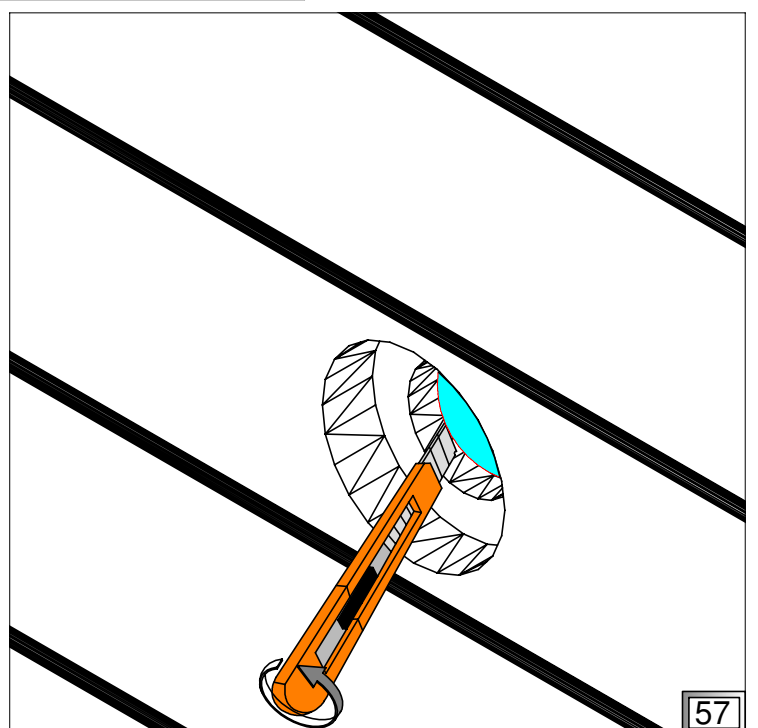
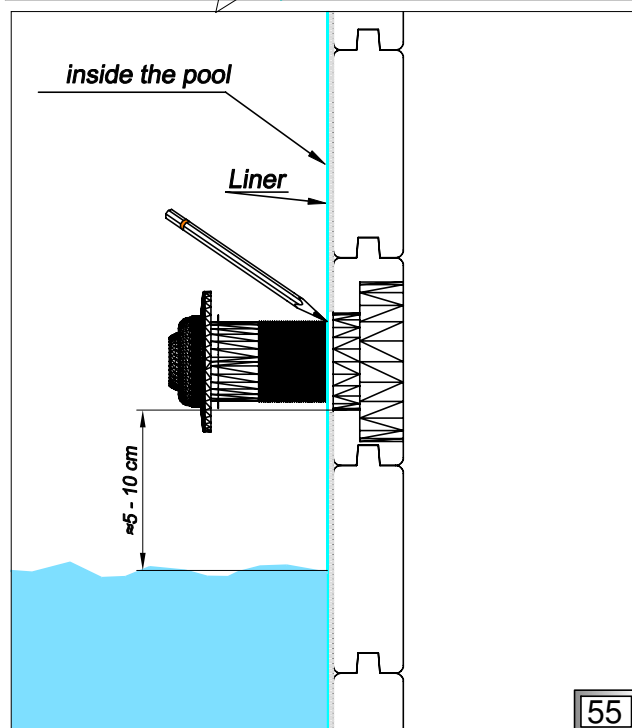
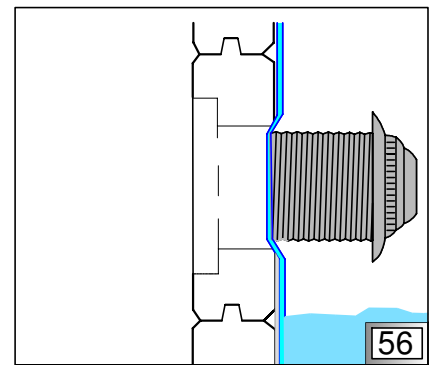
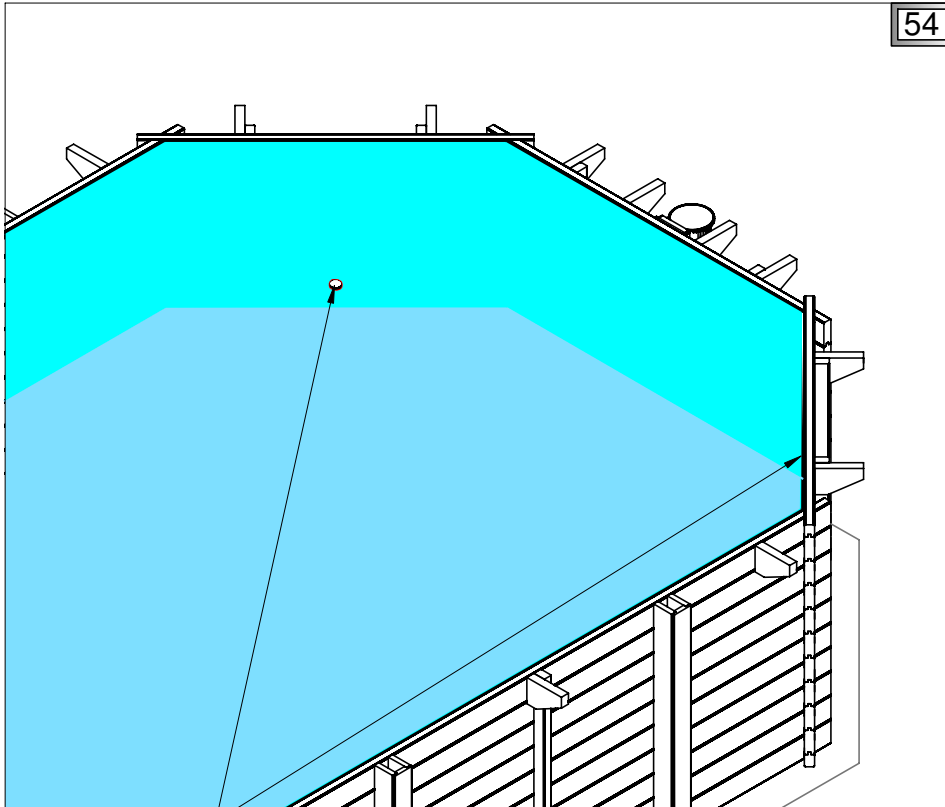
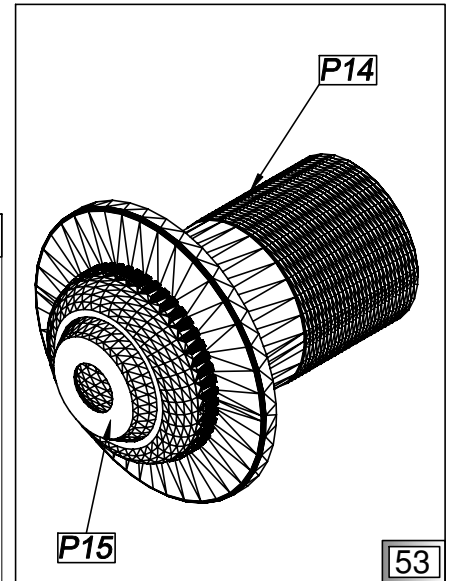
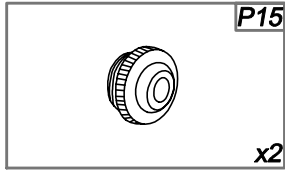
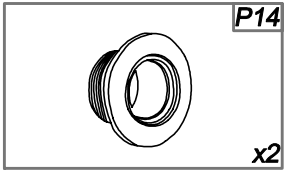

PL Dysze

GB Nozzles

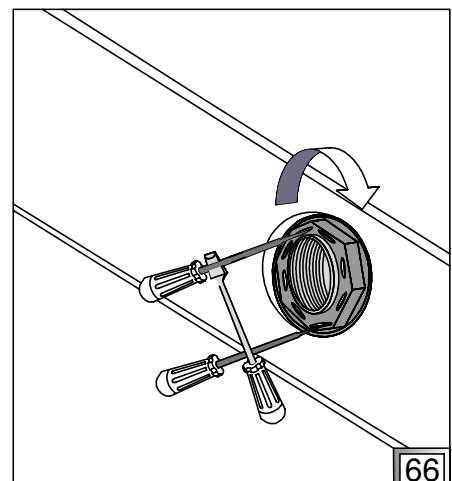
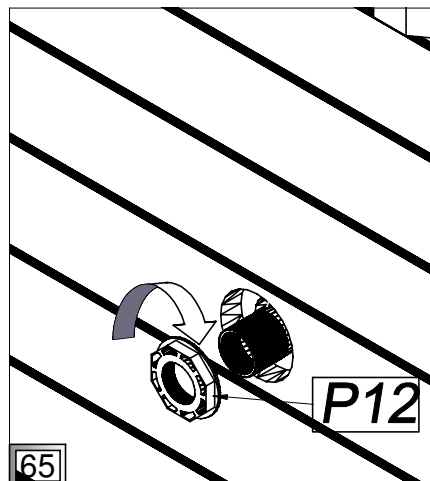
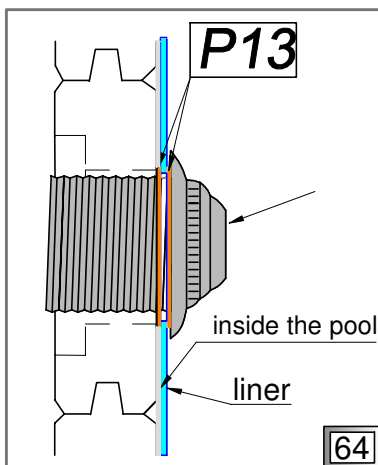
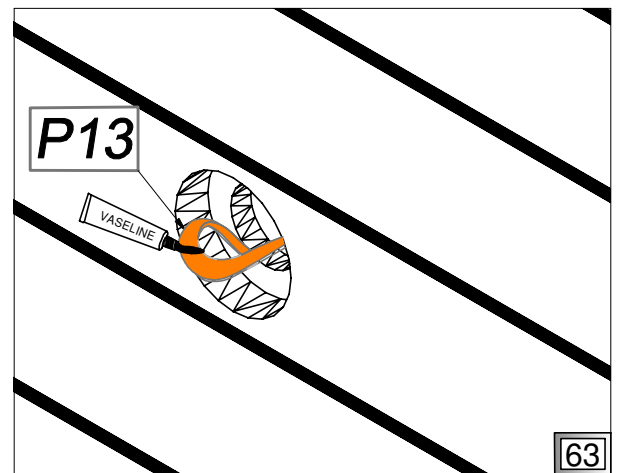
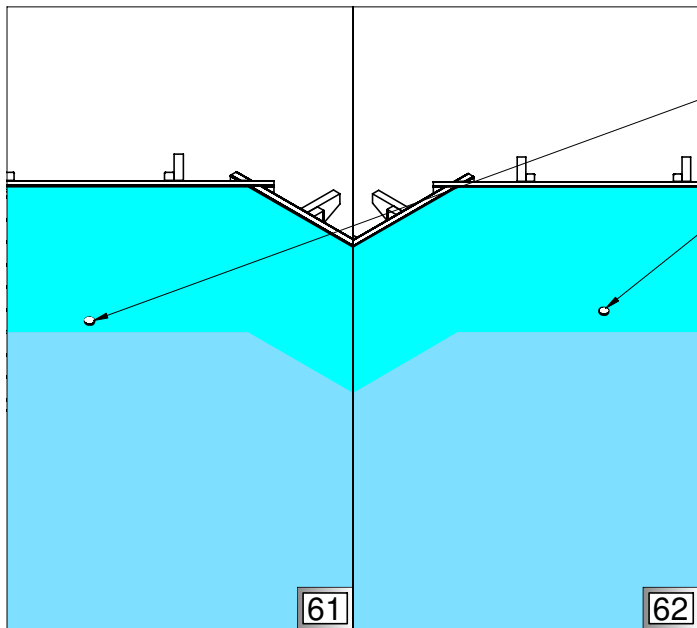
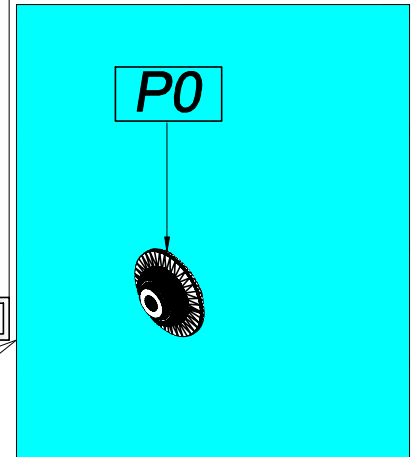
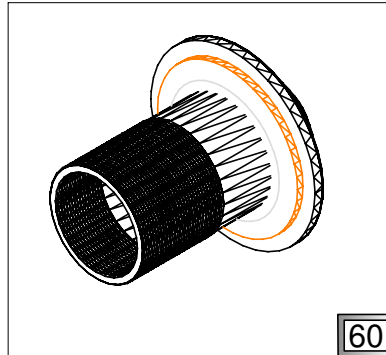
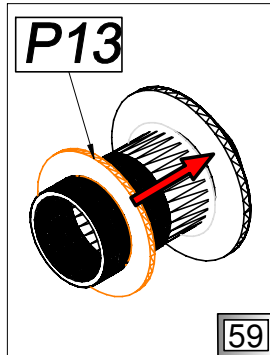
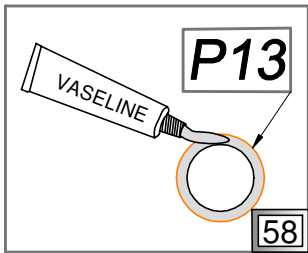
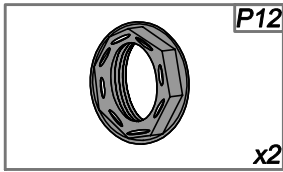
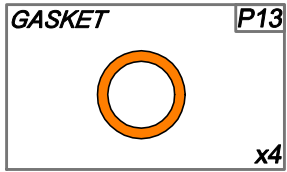

PL Dysze

GB Nozzles

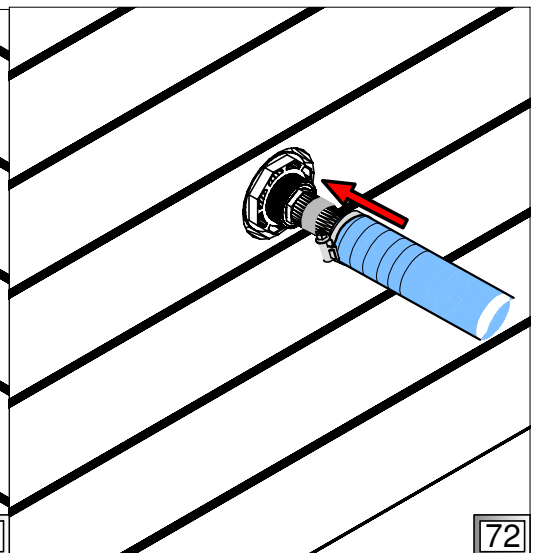
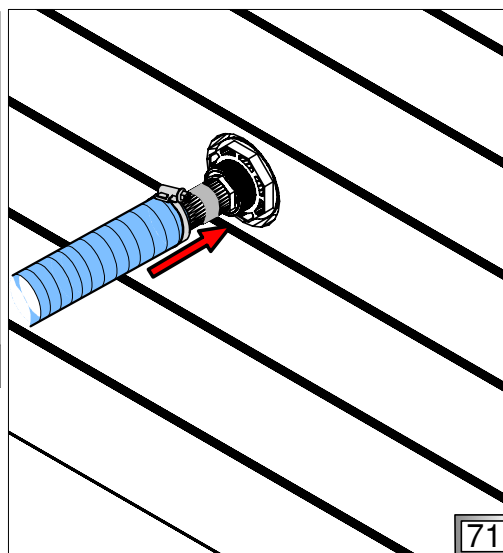
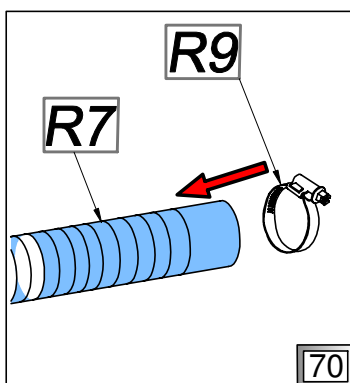
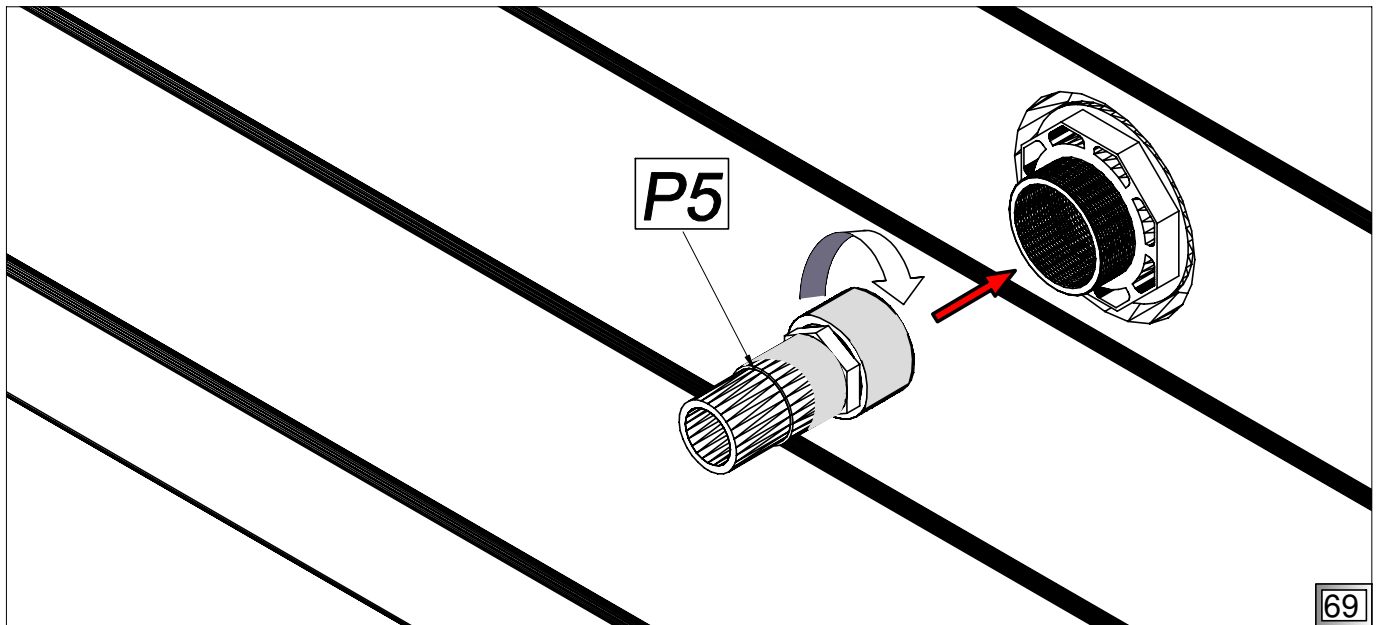
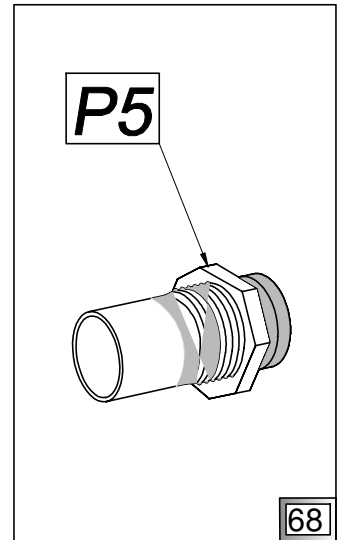
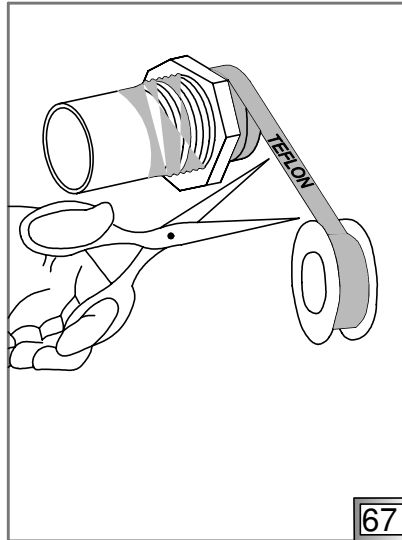
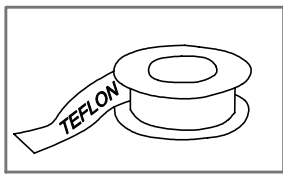
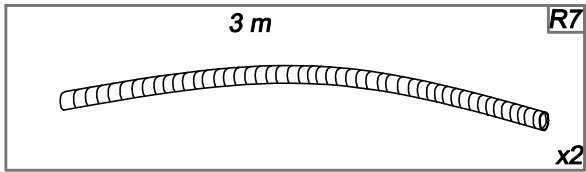
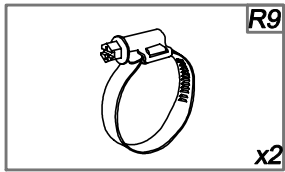
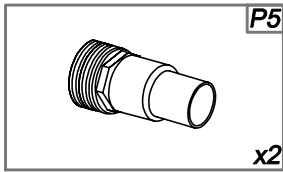

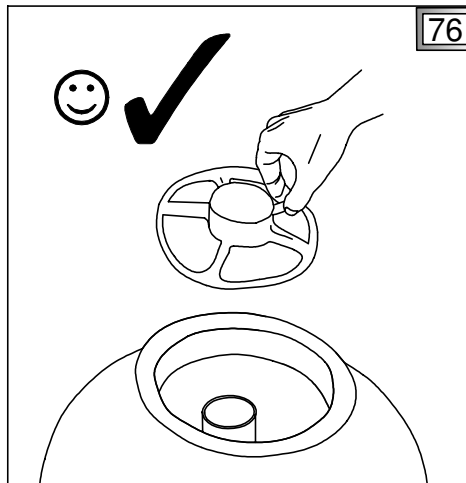
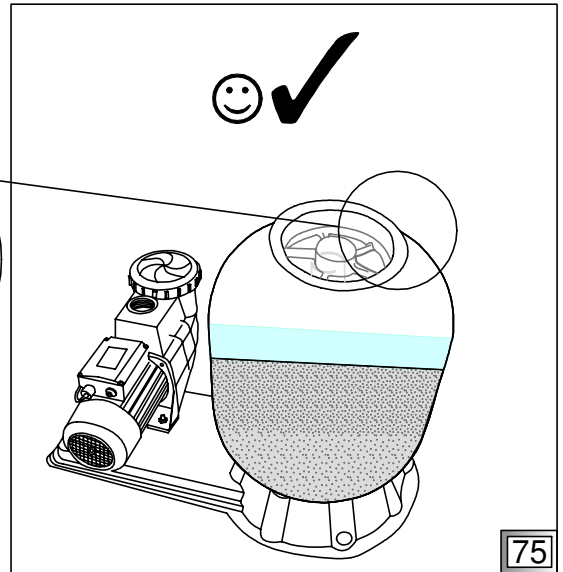
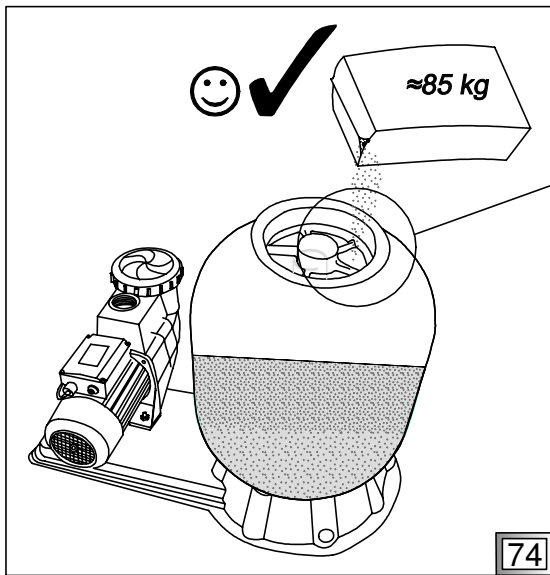
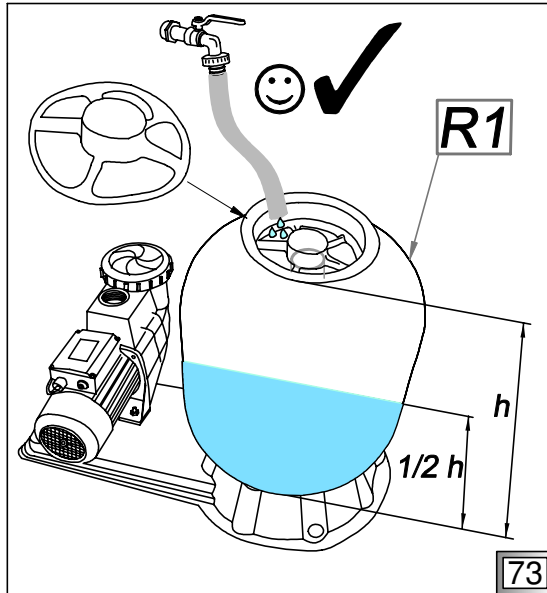
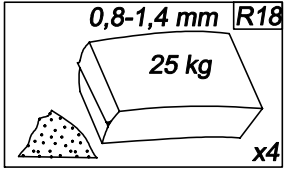

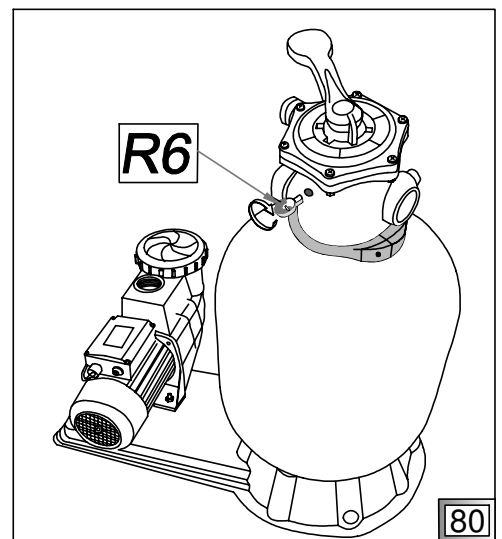
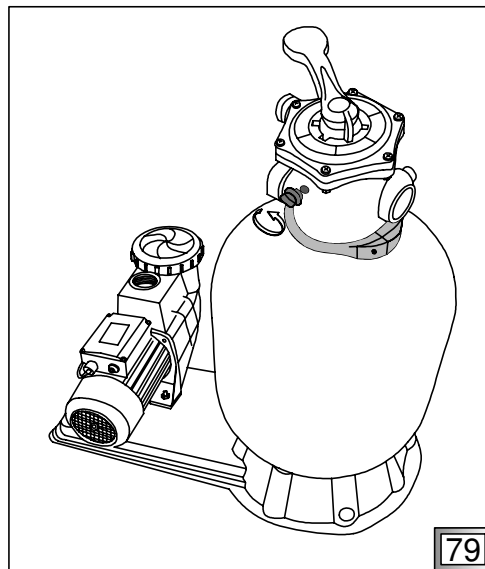
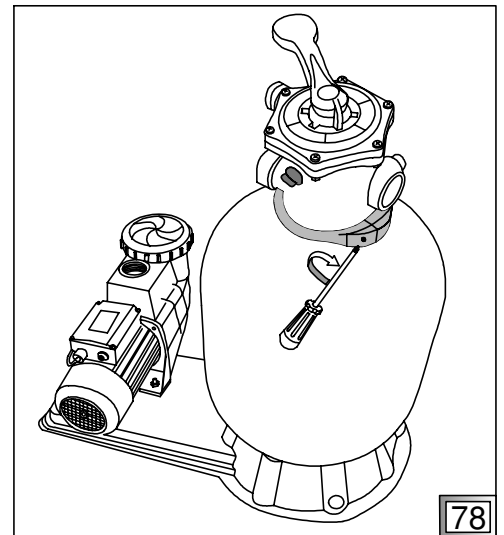
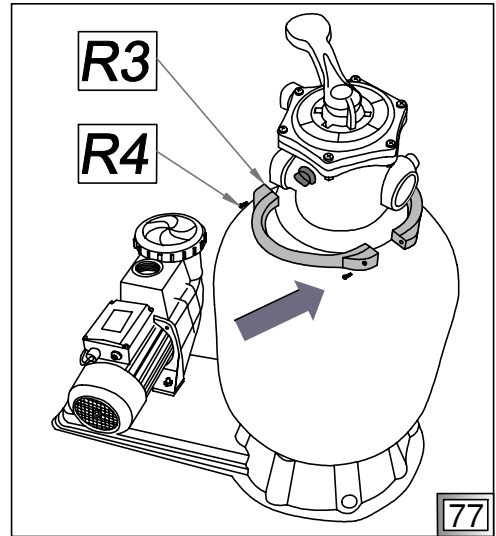
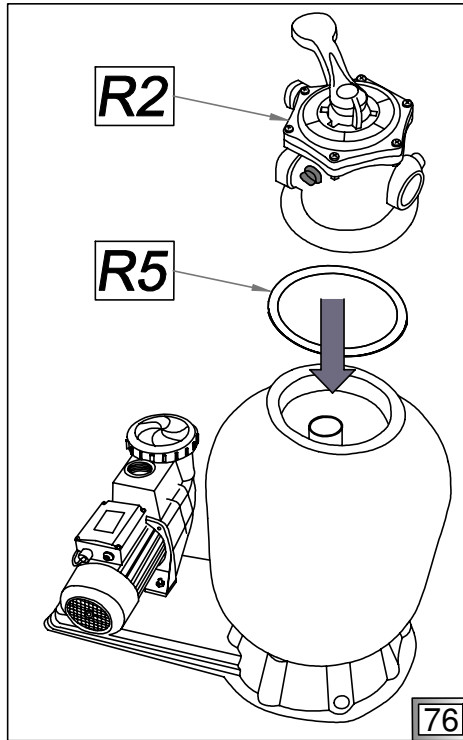
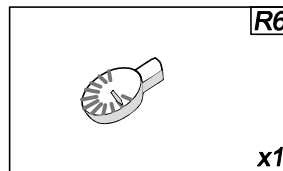
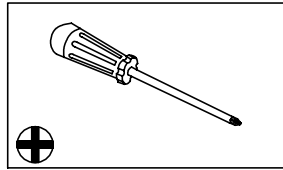
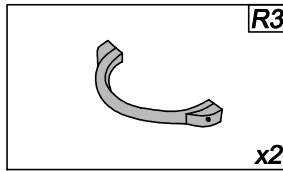
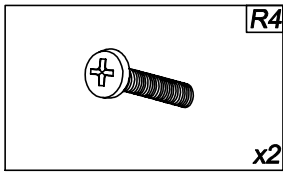
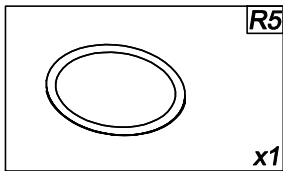
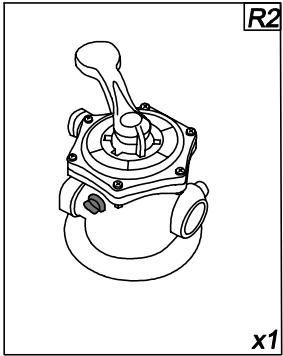

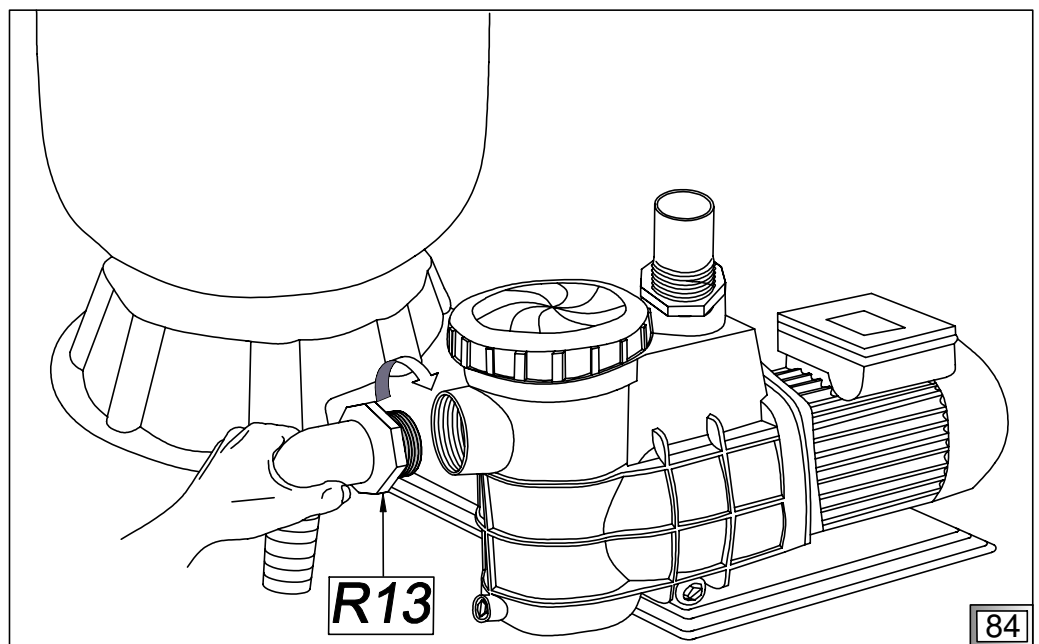
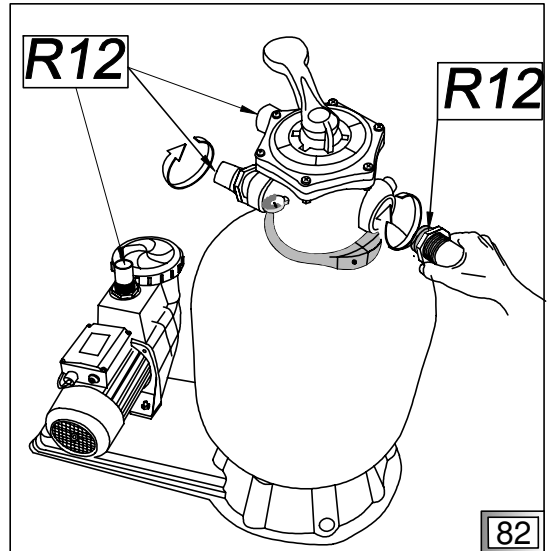
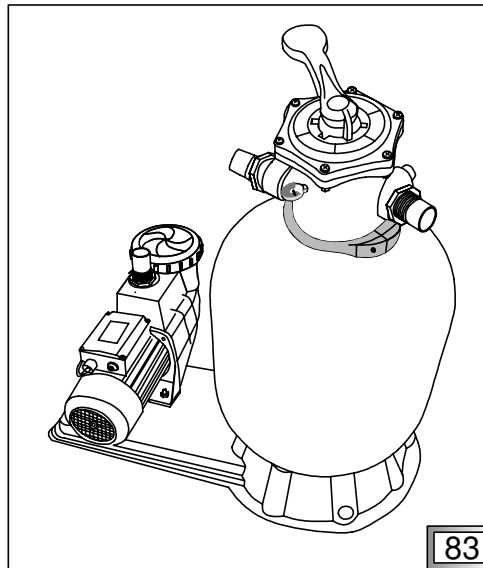
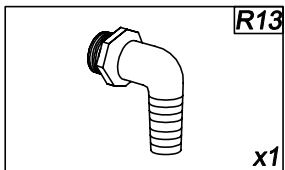
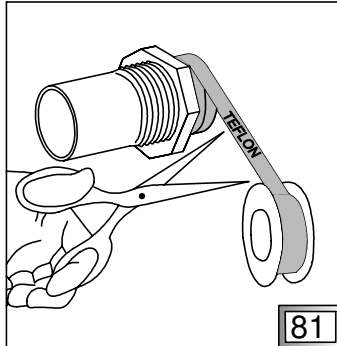
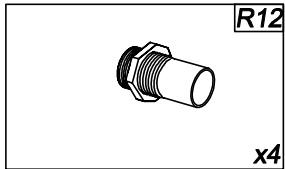

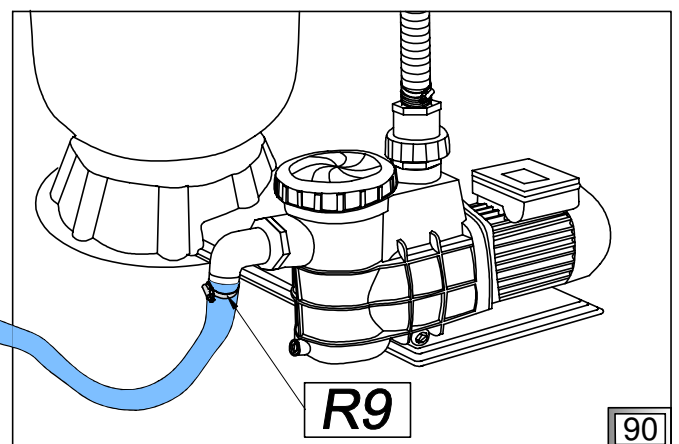
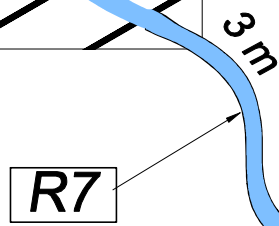
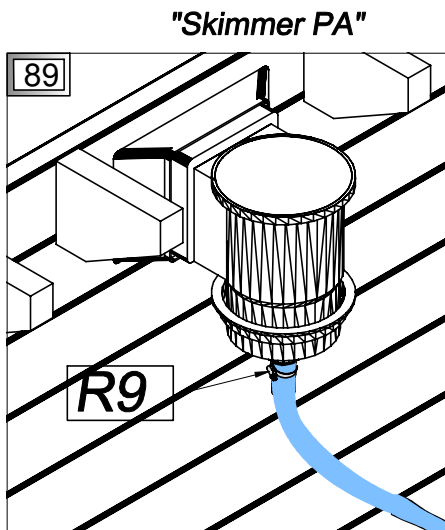
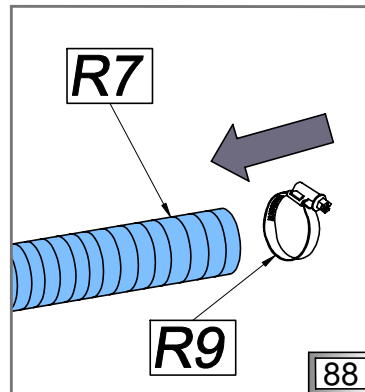
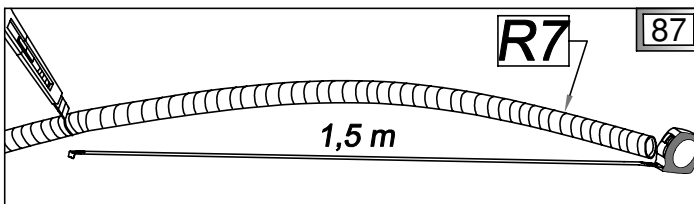
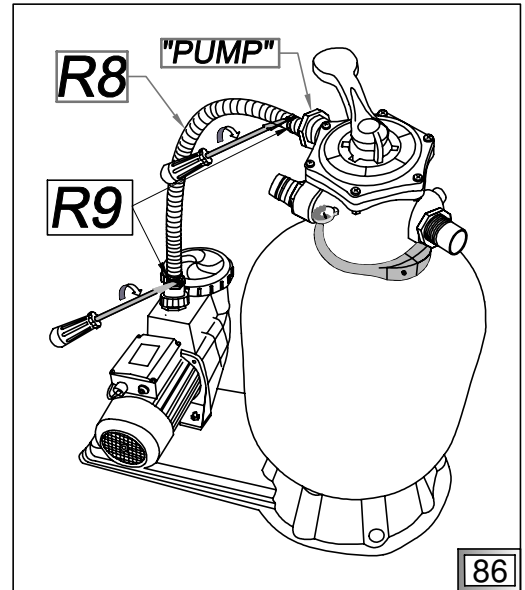
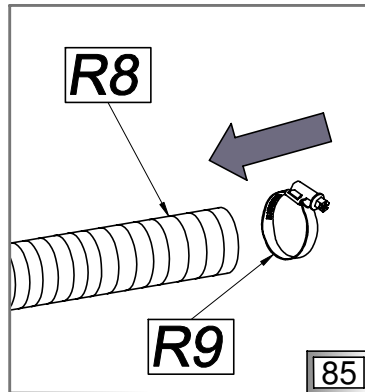
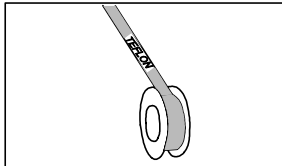
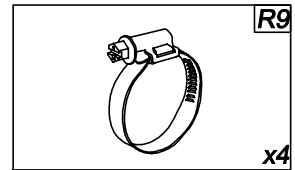
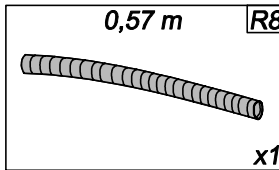
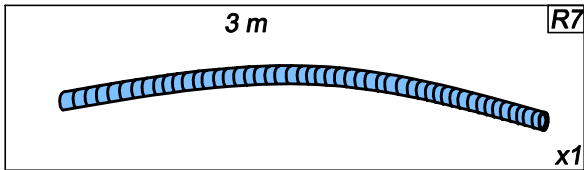

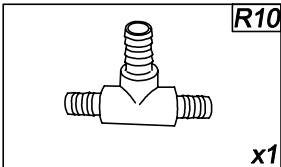
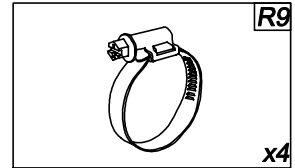
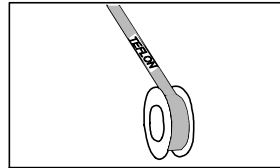
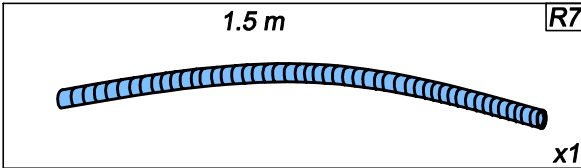

"Nozzle 2"

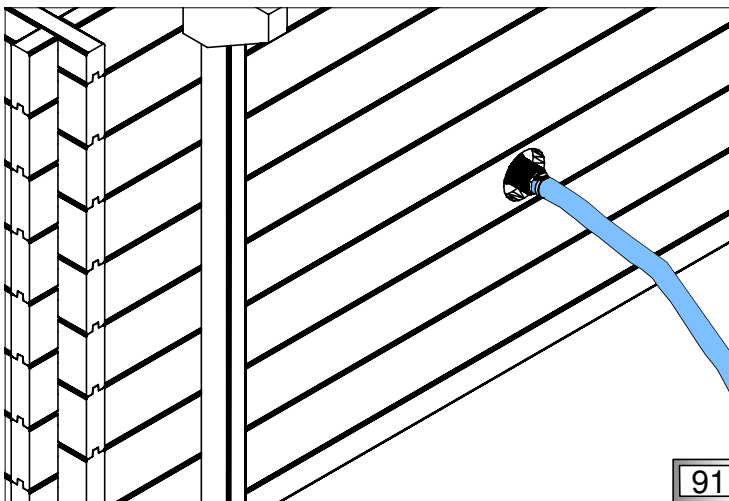

"Nozzle 1"

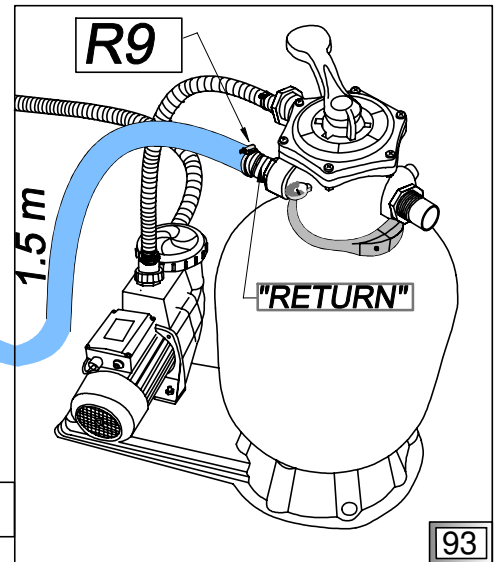
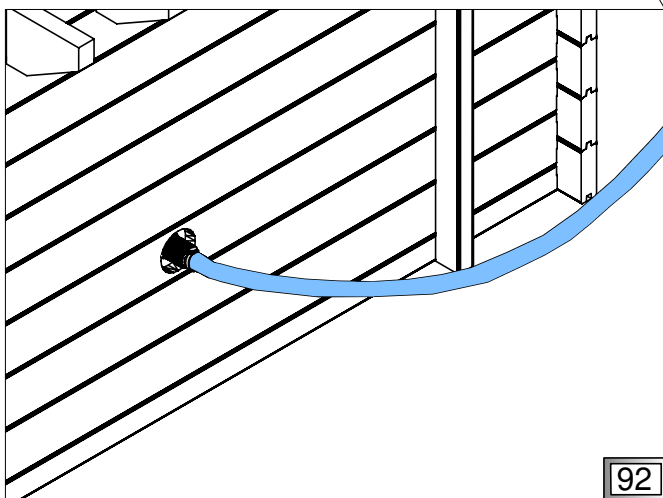

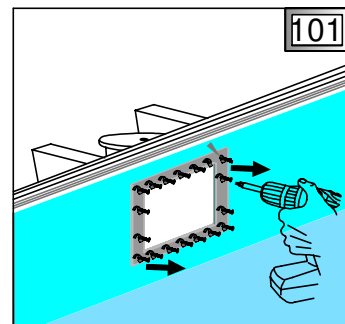
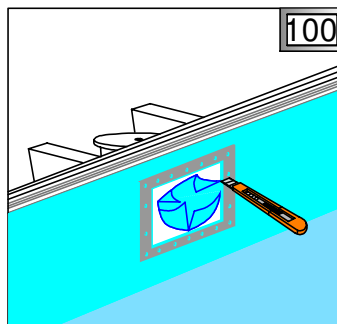
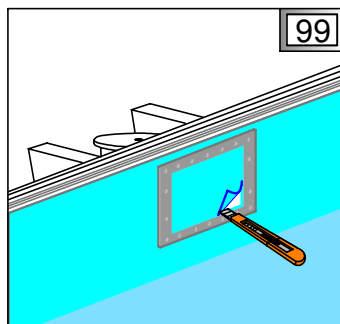
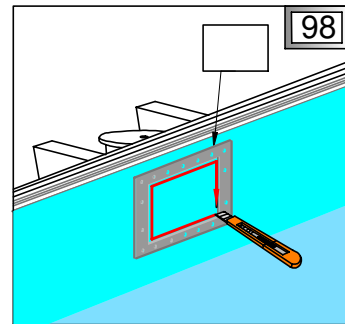
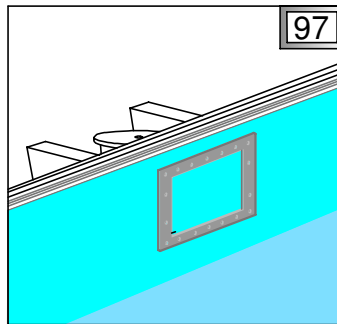
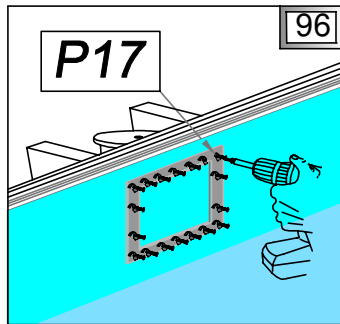
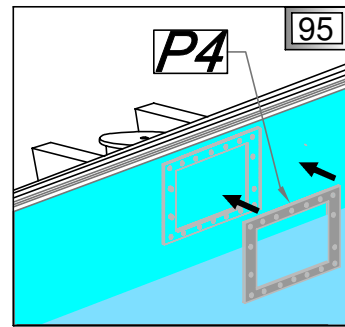
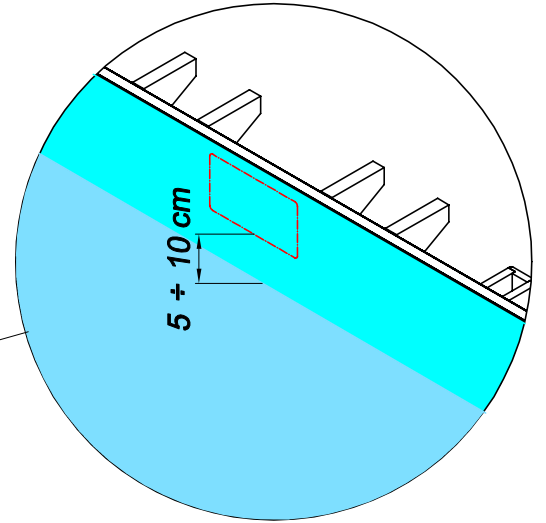
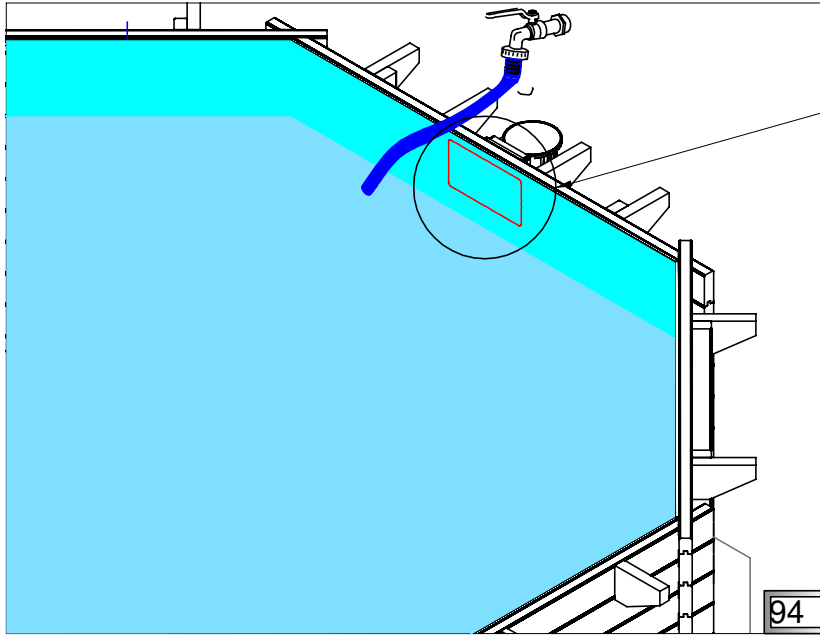
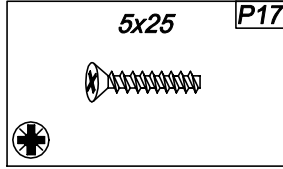
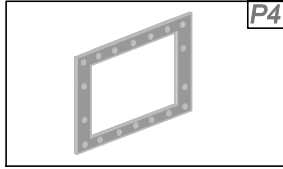

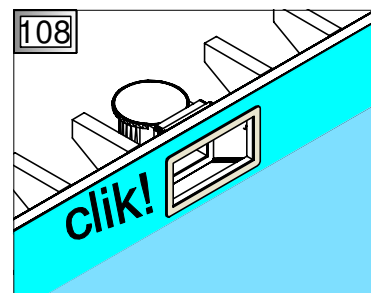
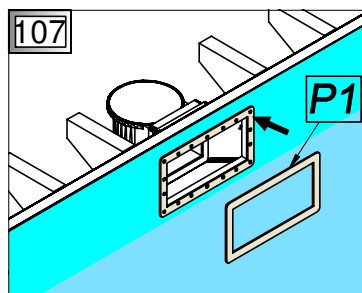
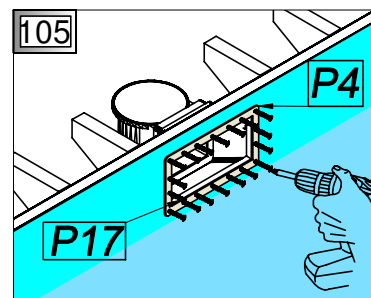
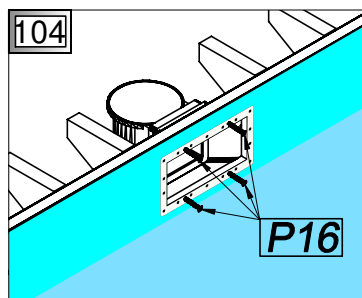
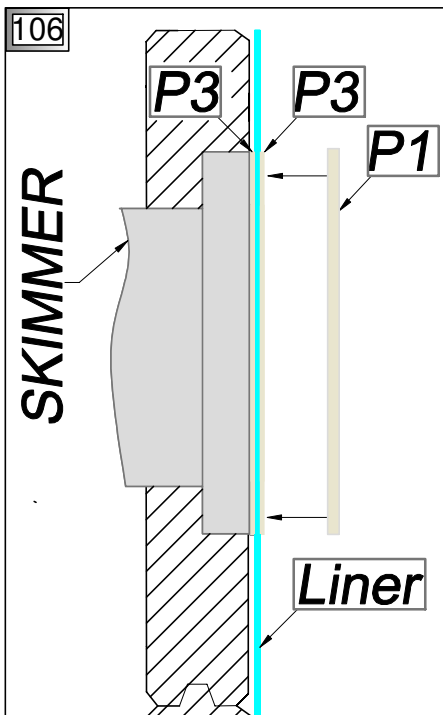
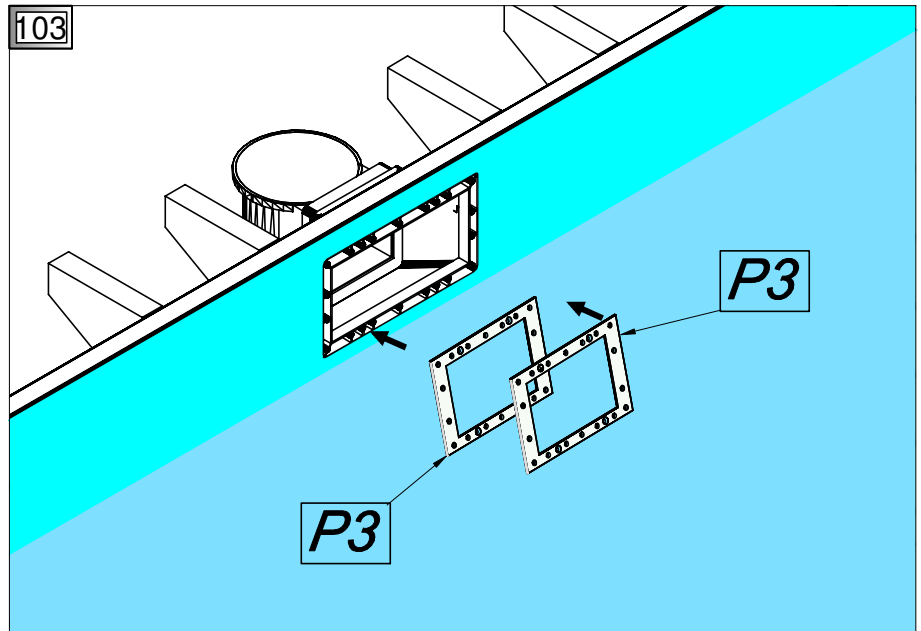
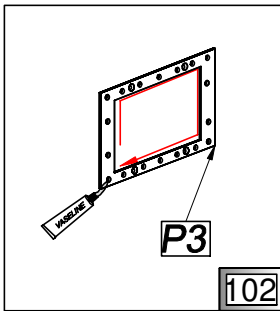
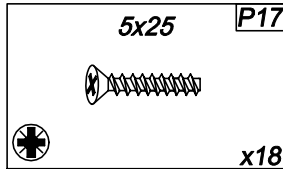
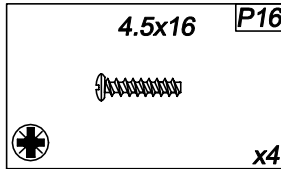
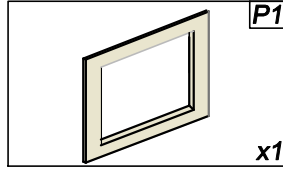
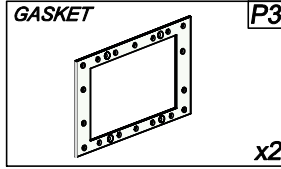
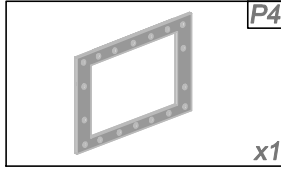

PL Napełnianie wodą

GB Filling water

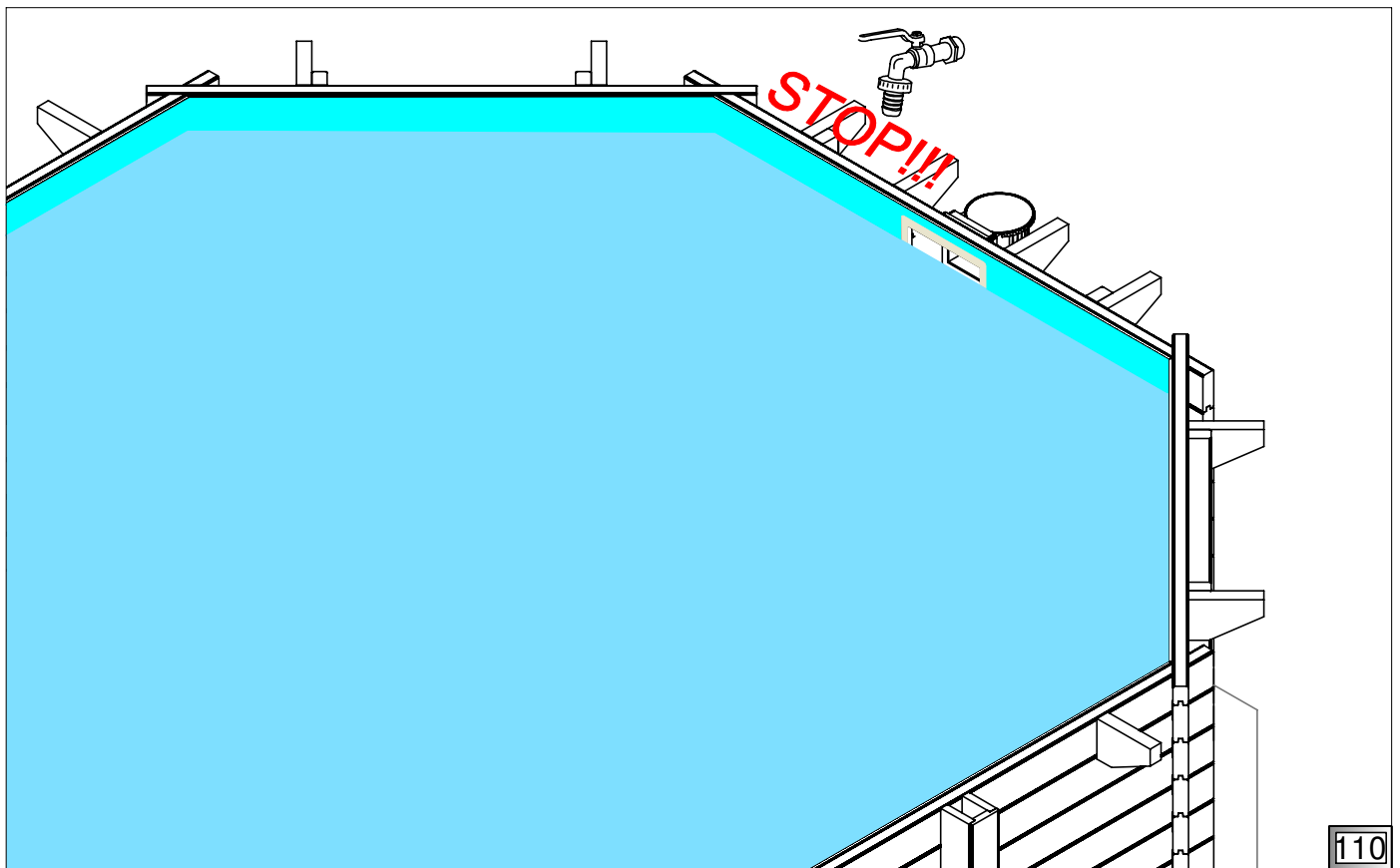
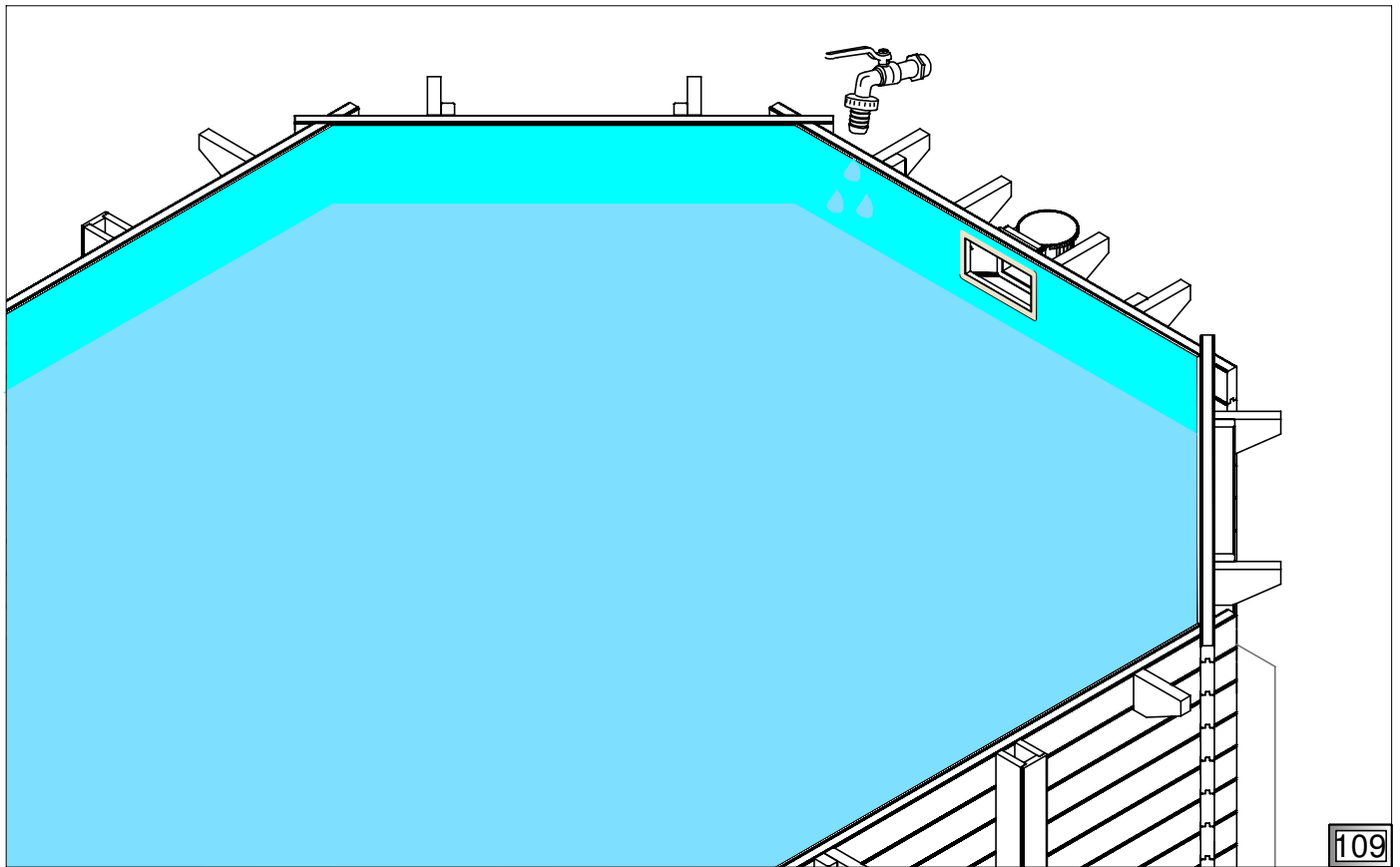

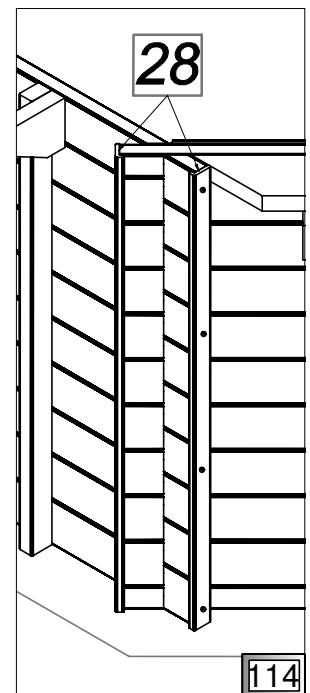
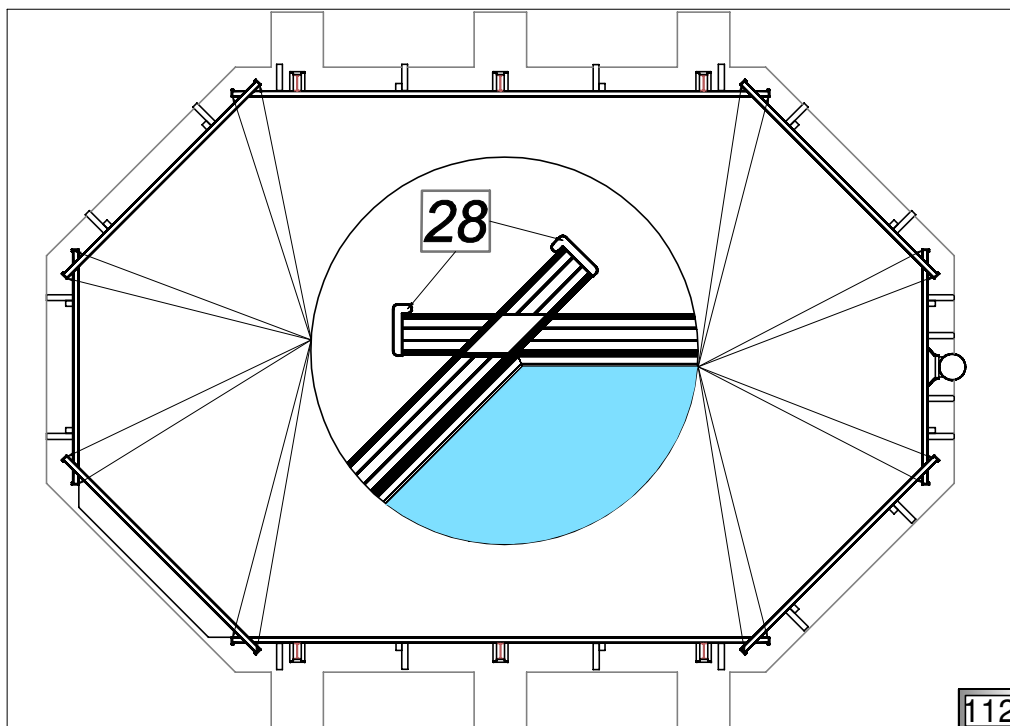
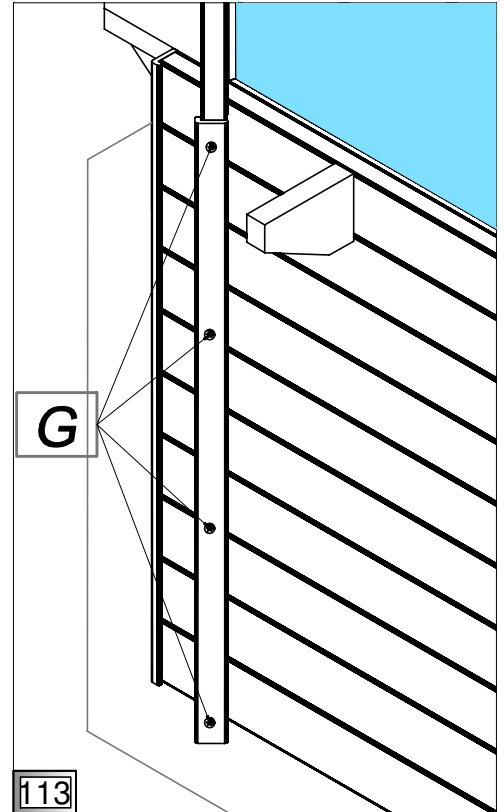
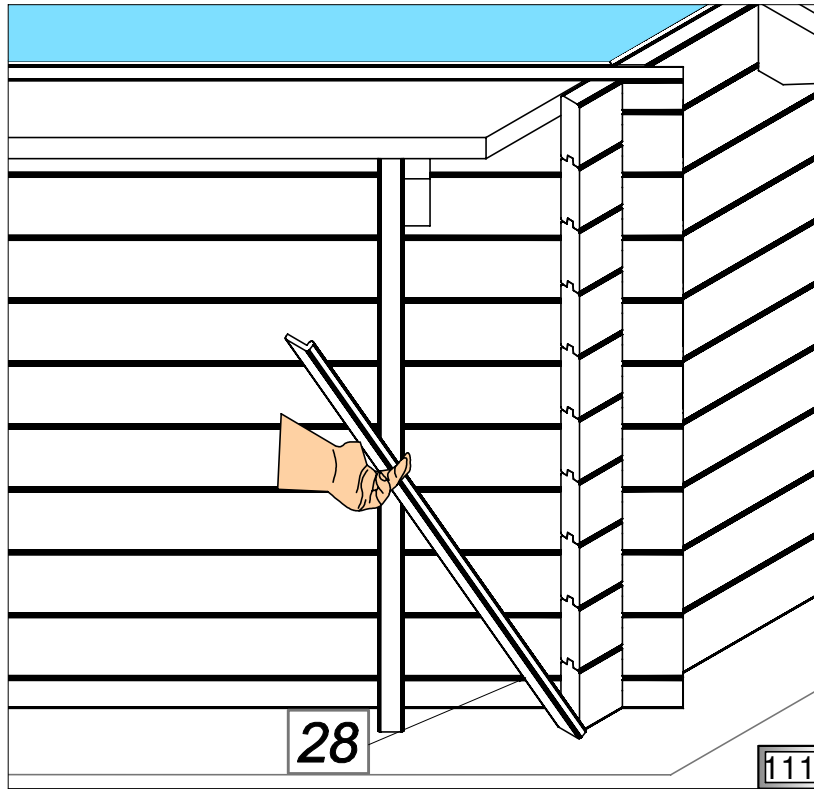
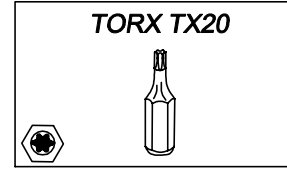
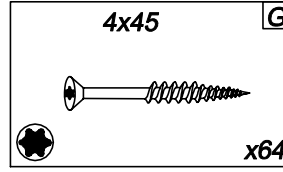
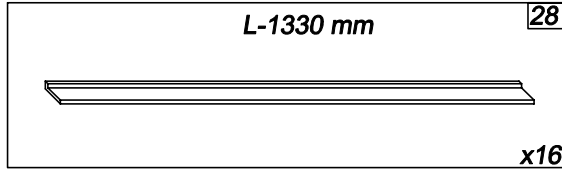

PL Taras

GB Terrace

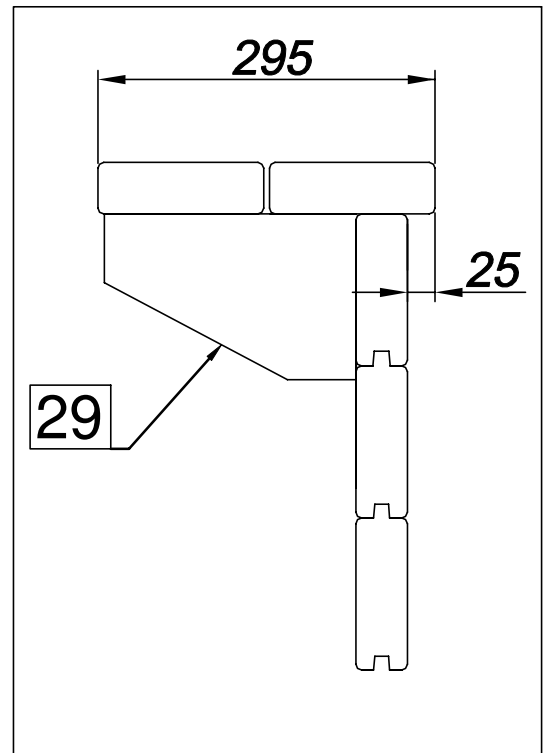
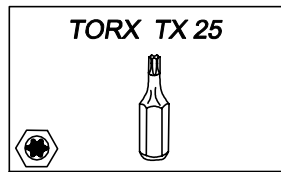
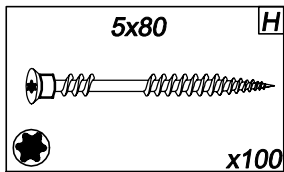
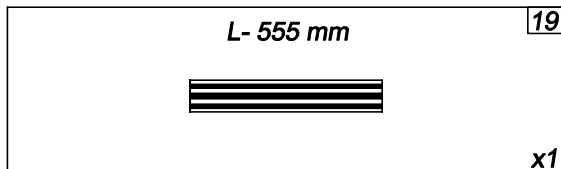
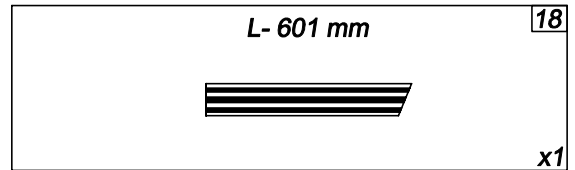
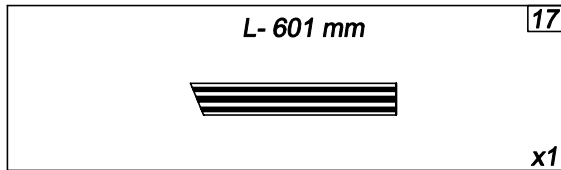
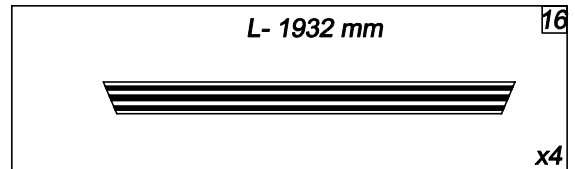
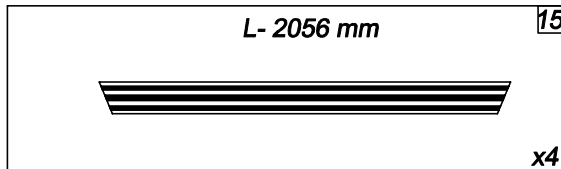
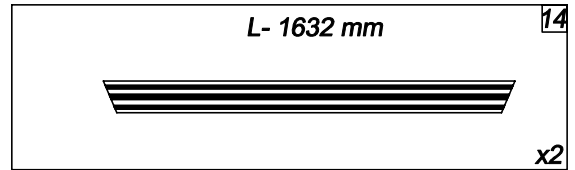
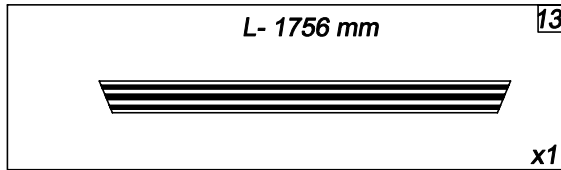
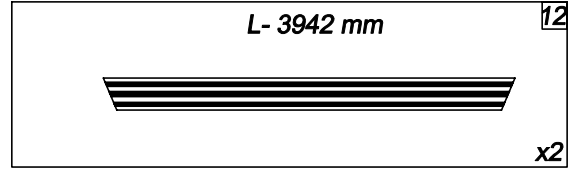
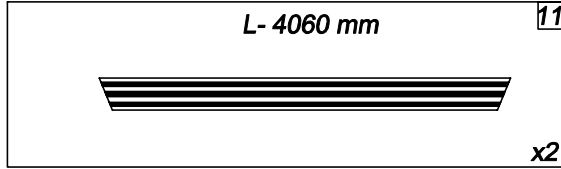

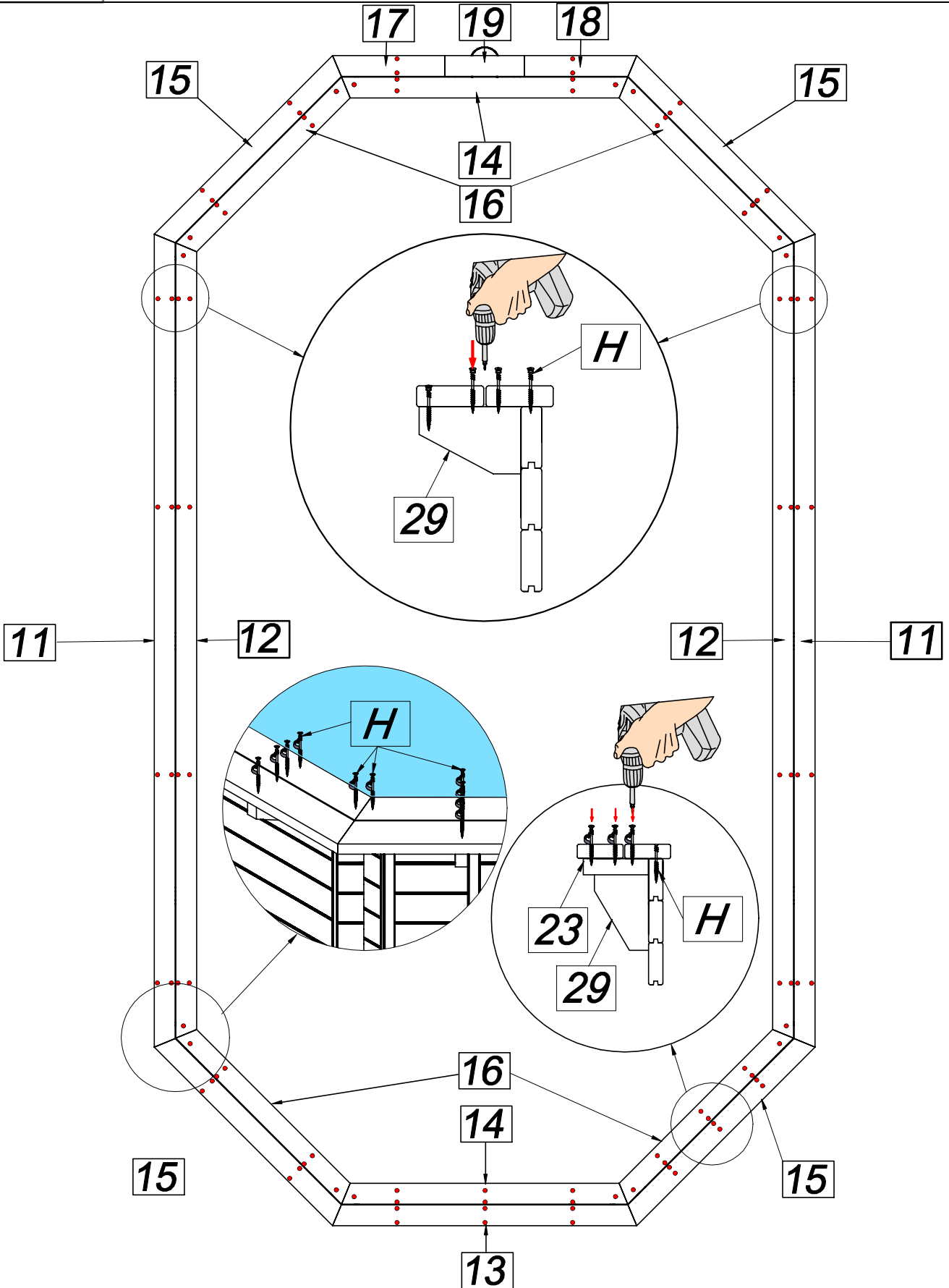

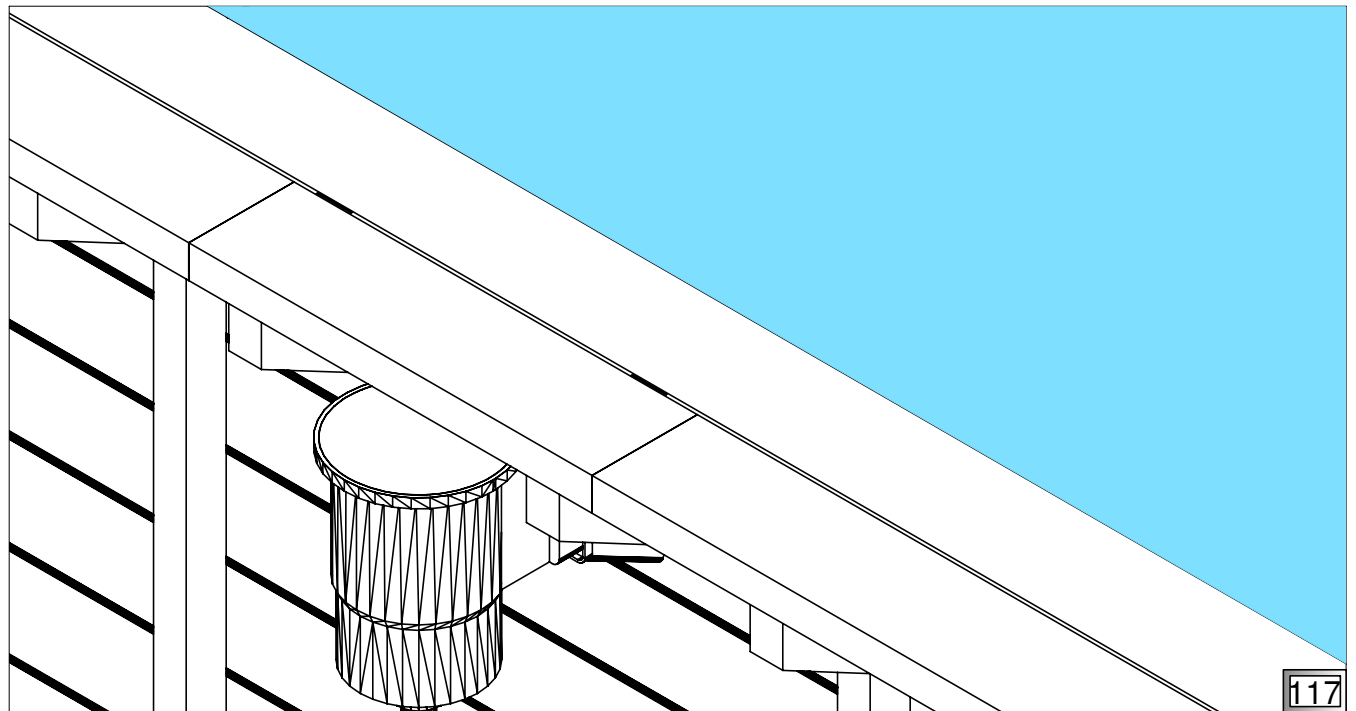
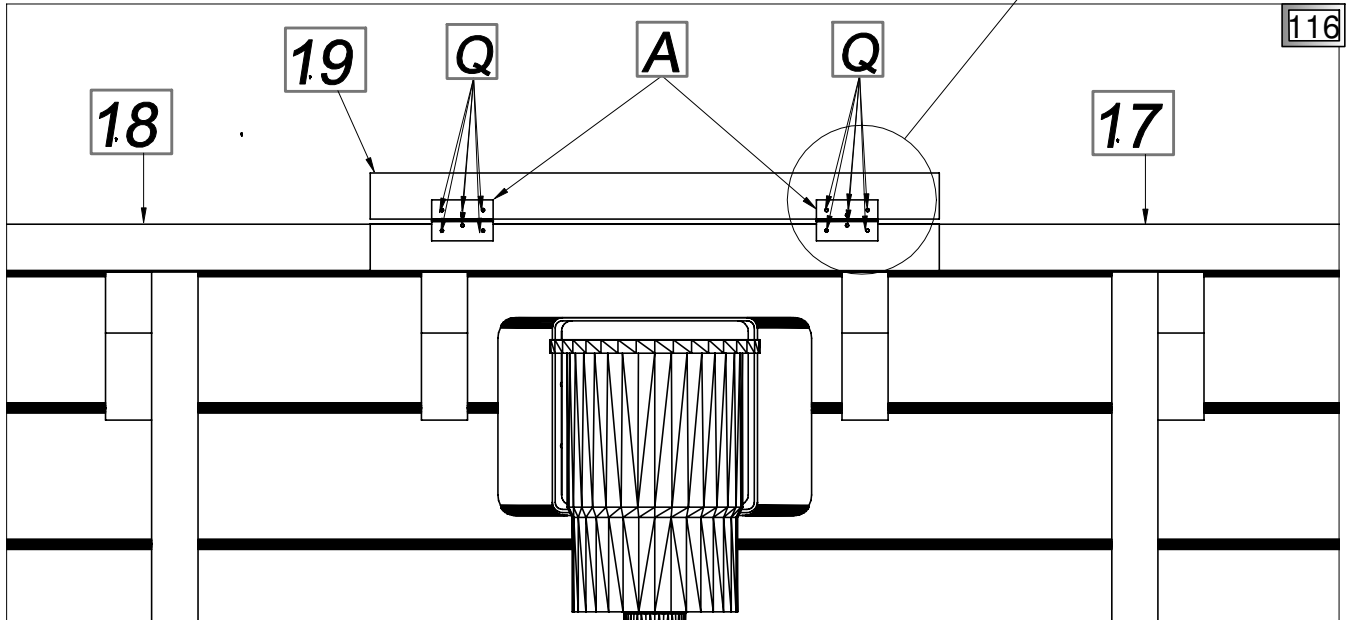
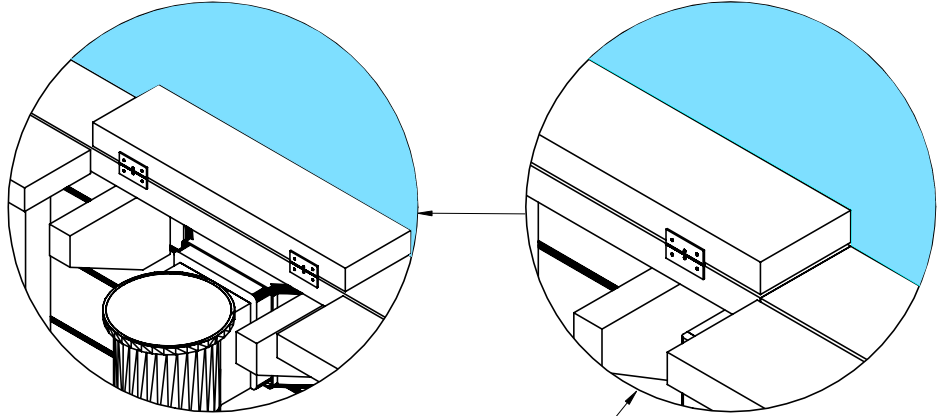
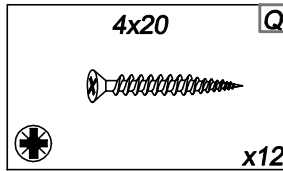
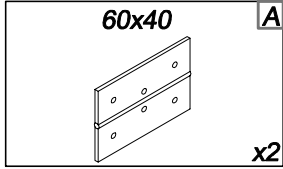

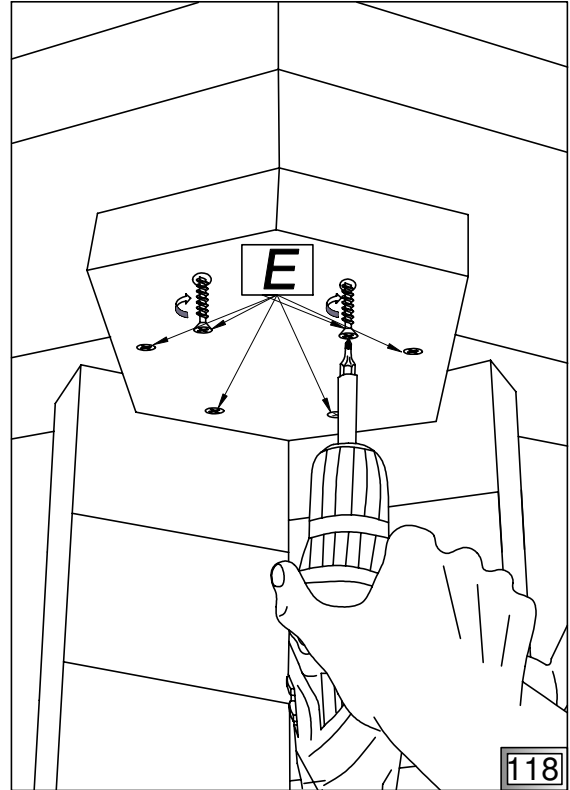
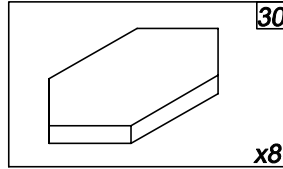
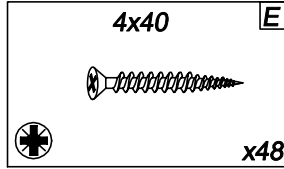

PL Widok od spodu tarasu.

GB View from the bottom of terrace.

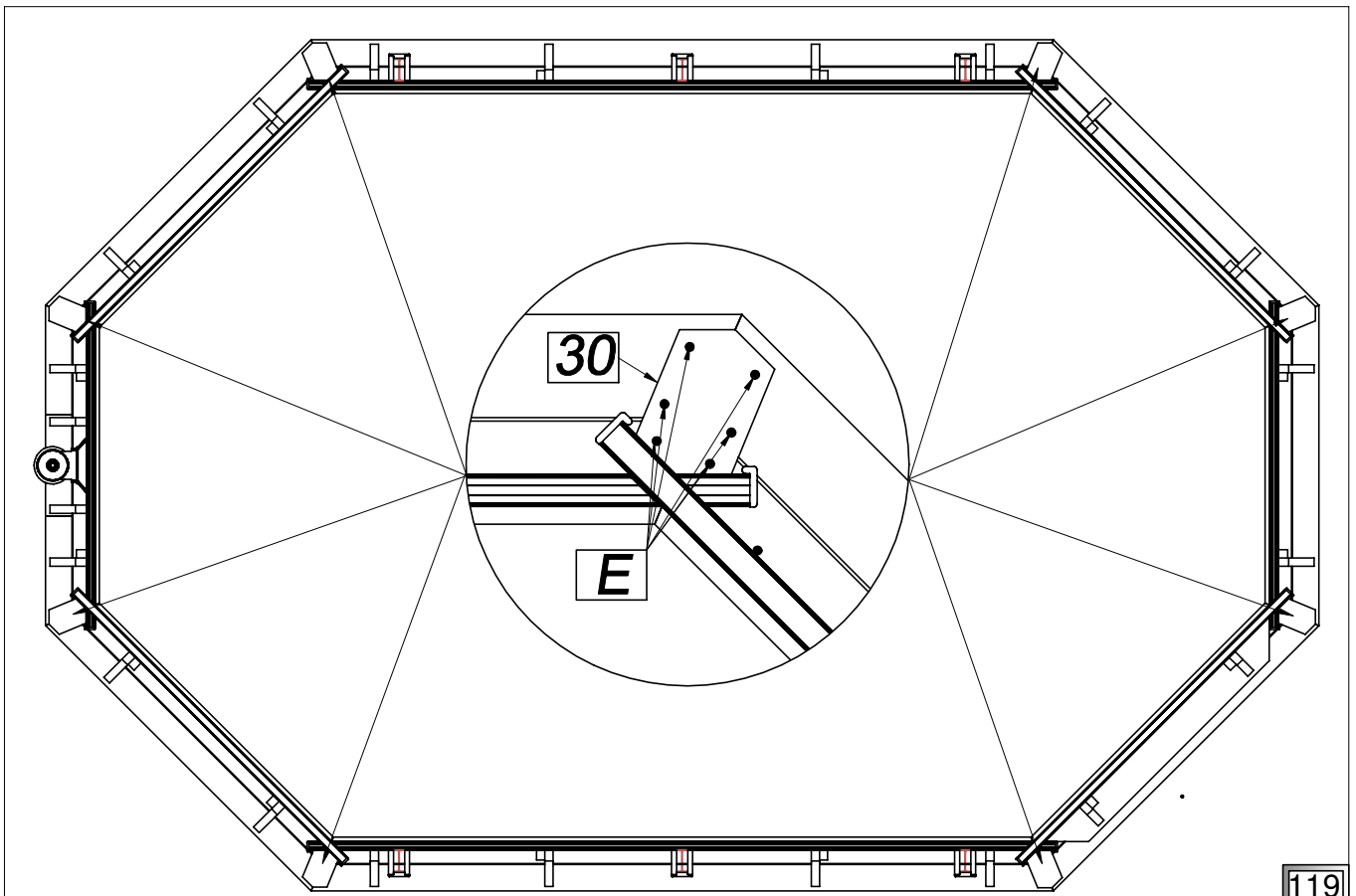

PL Schody drewniane

GB Wooden stairs

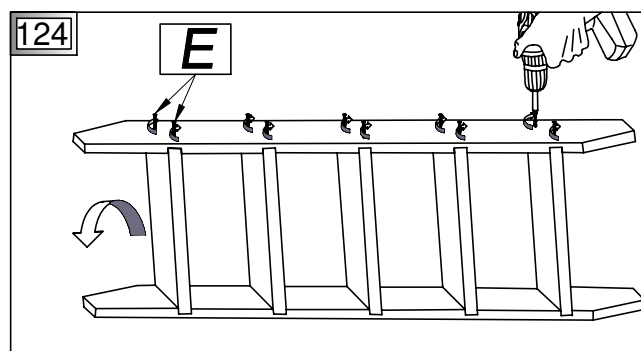
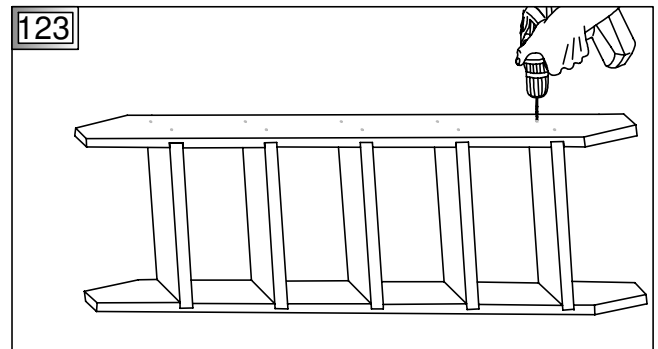
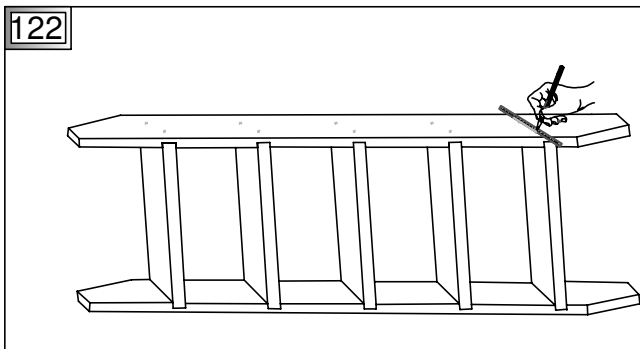
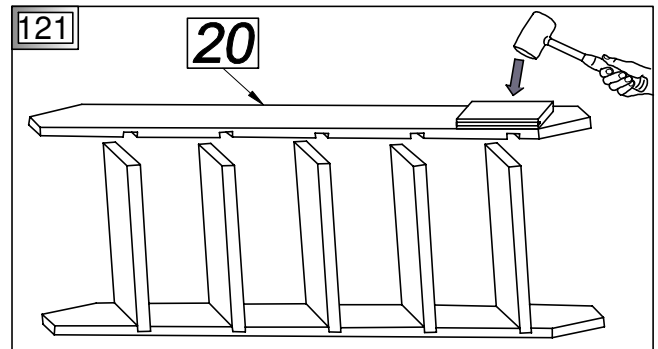
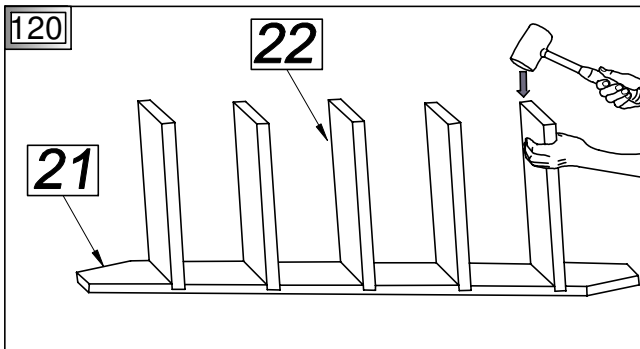
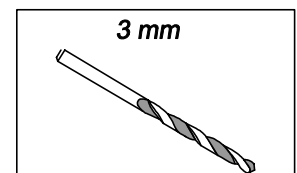
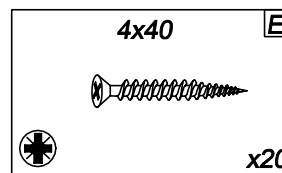
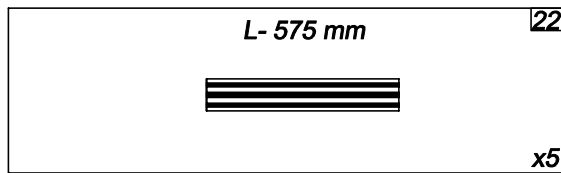
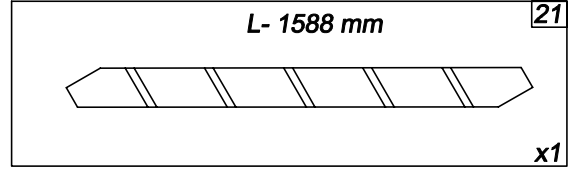
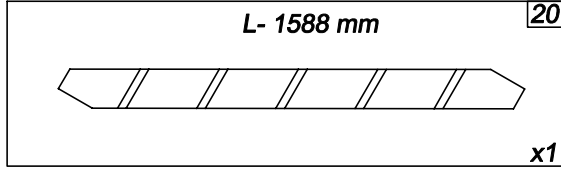

PL Schody drewniane

GB Wooden stairs

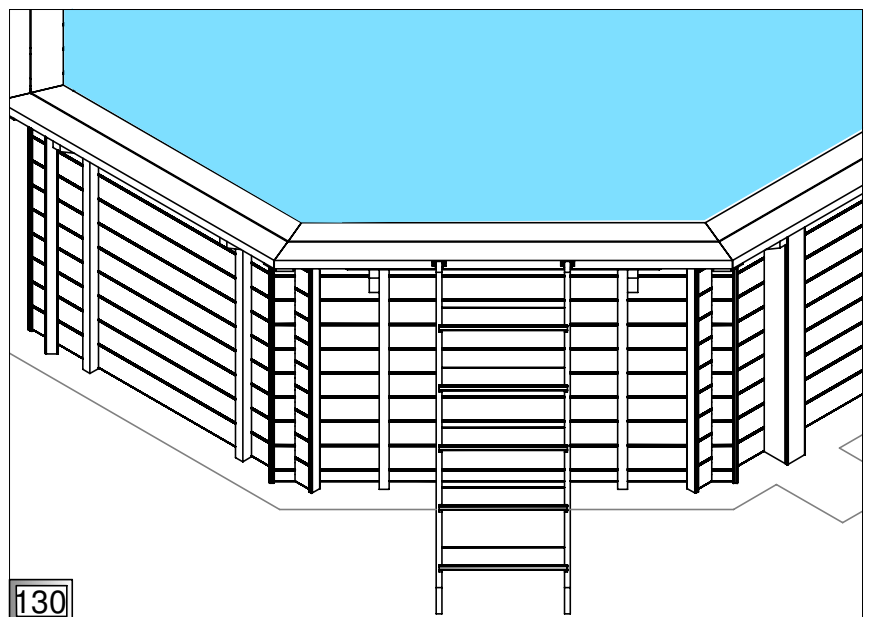
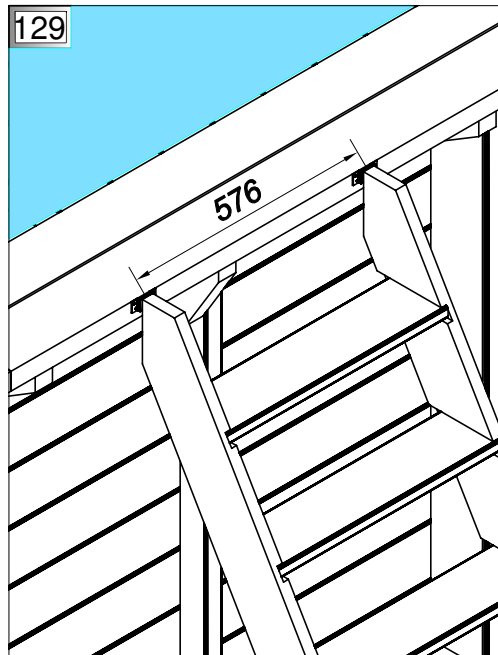
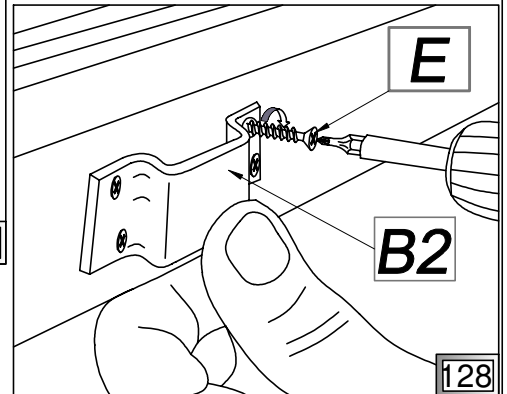
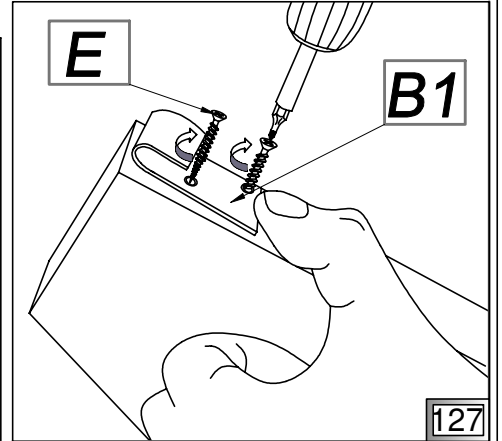
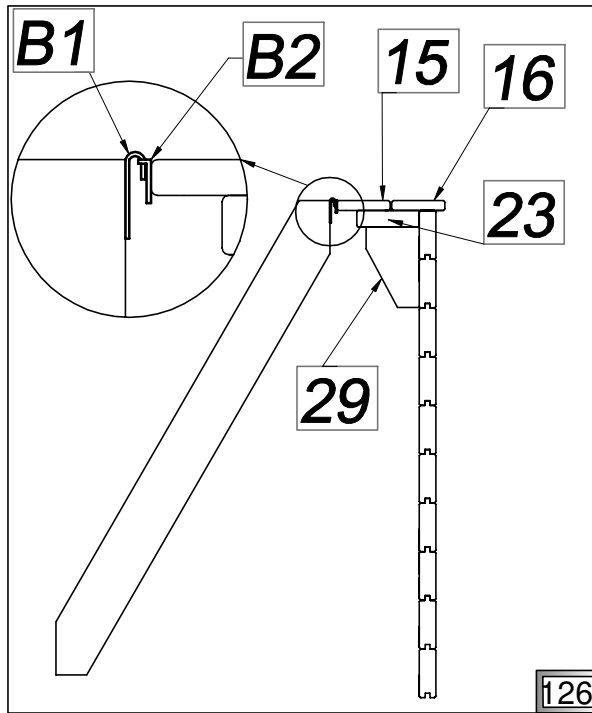
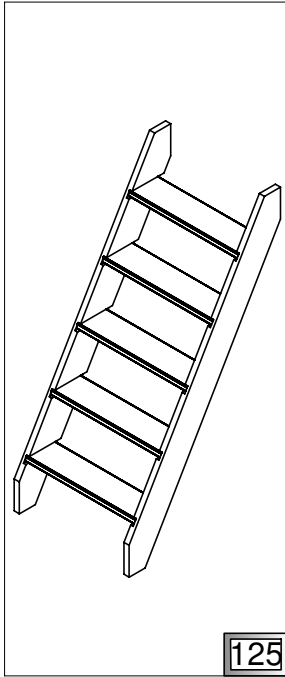
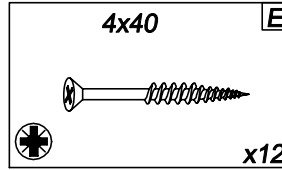
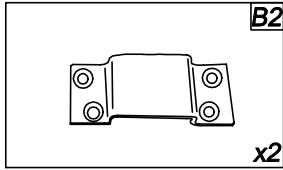
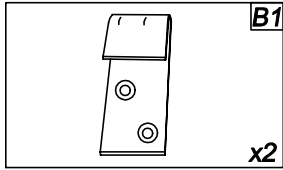

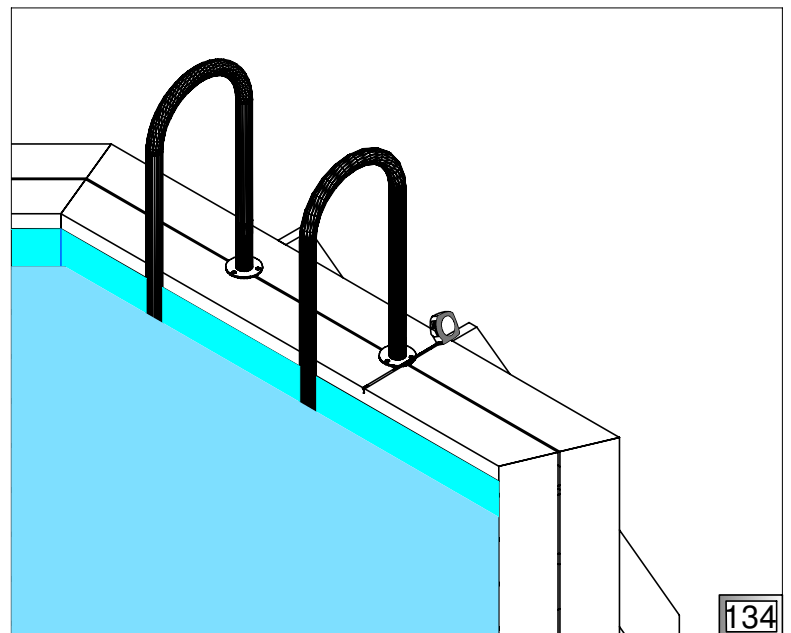
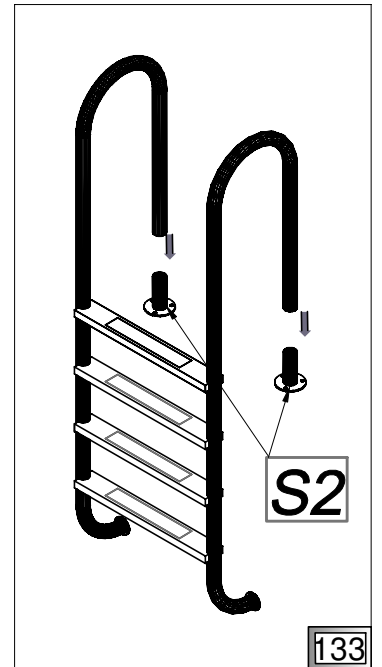
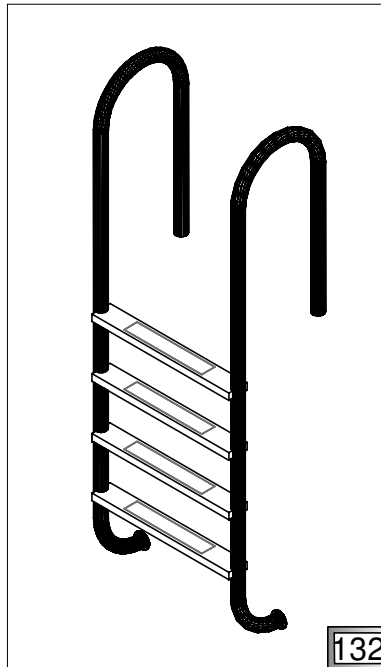
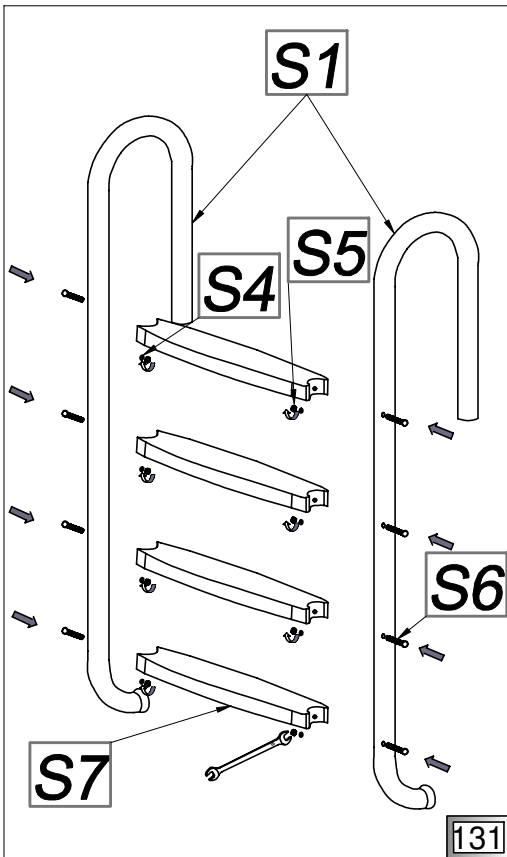
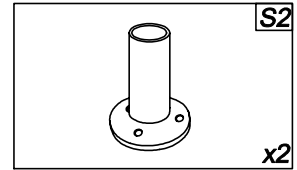
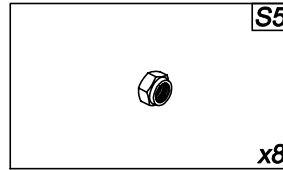
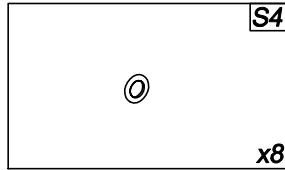
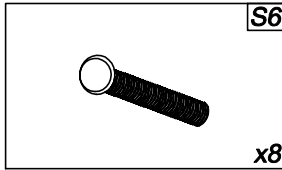
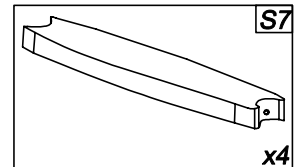
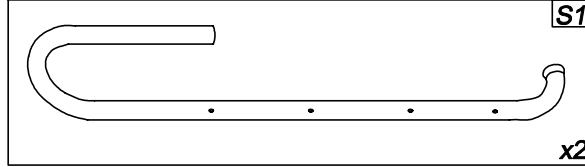
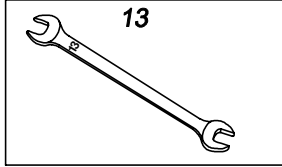

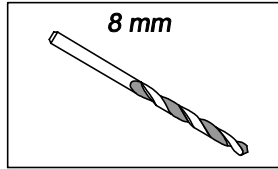
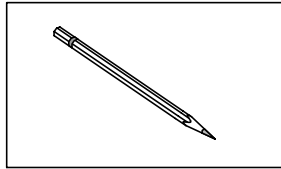
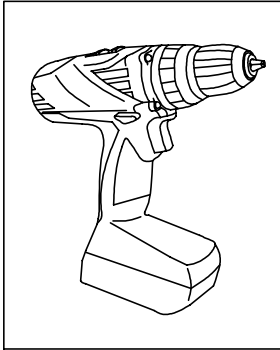
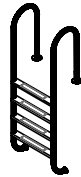

PL Otwór wykonać na przelot w celu wprowadzenie okucia S8

GB Make a hole through boards to put in the fittings S8

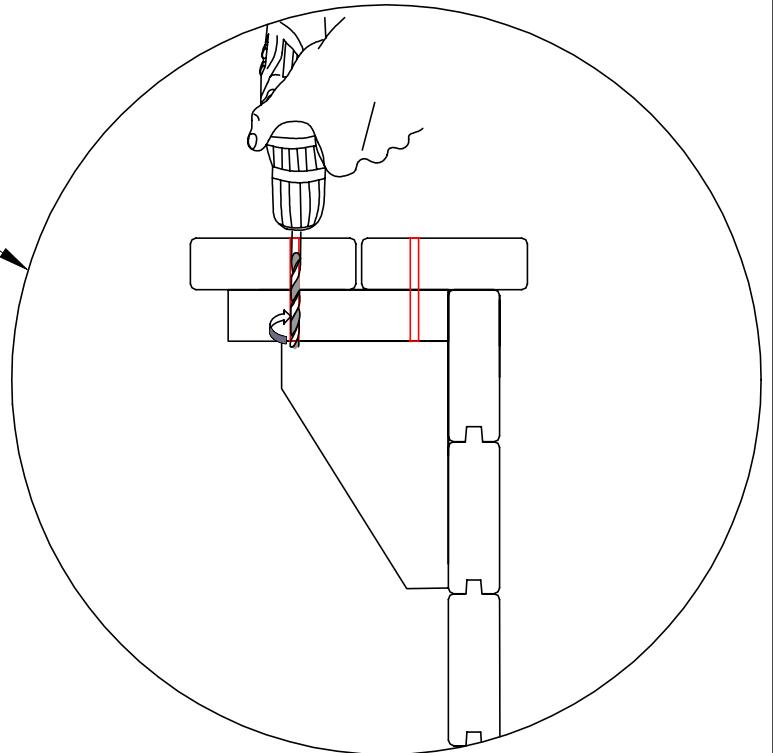
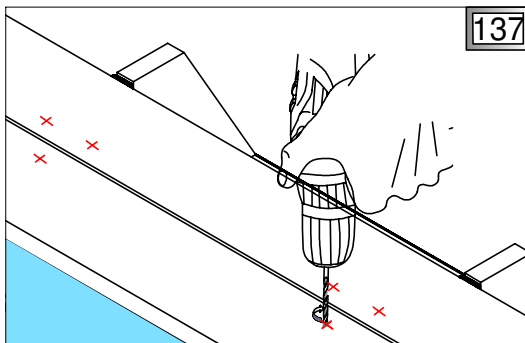
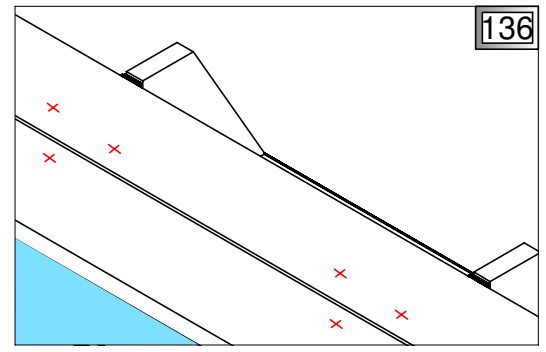
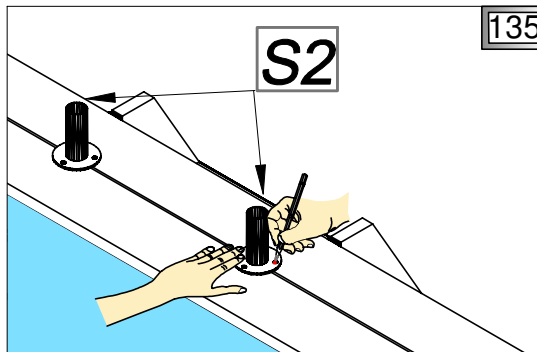

(PL) Drabinka stalowa

(GB) Stainless steel ladder

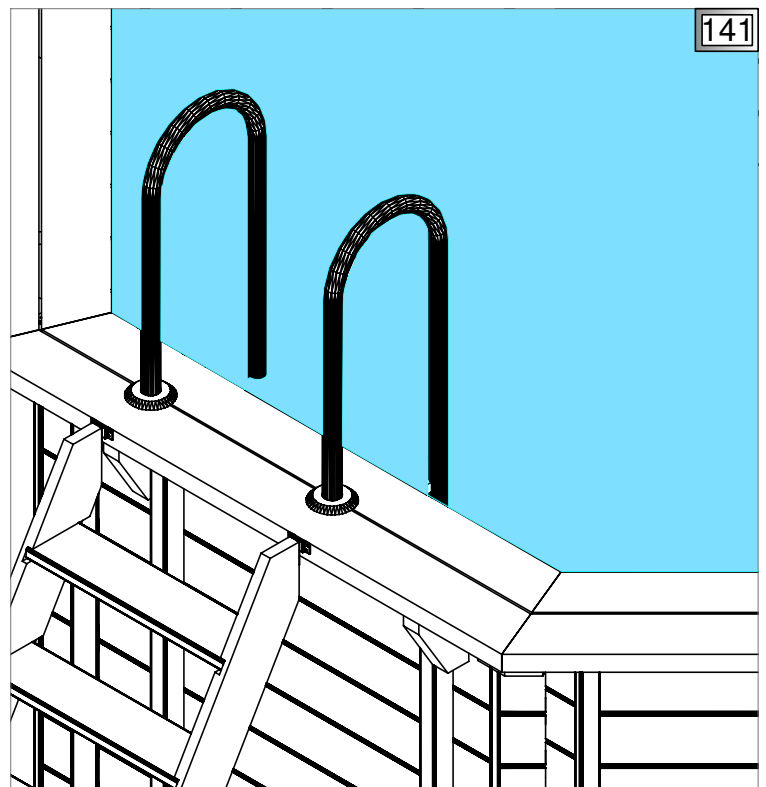
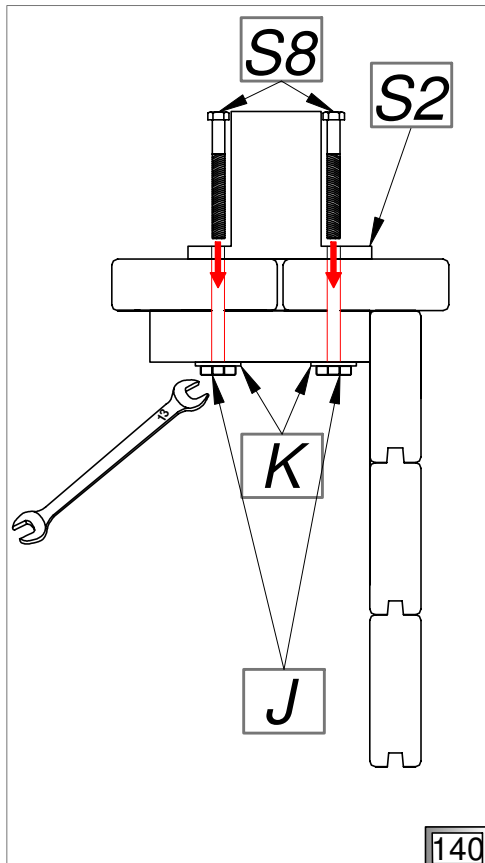
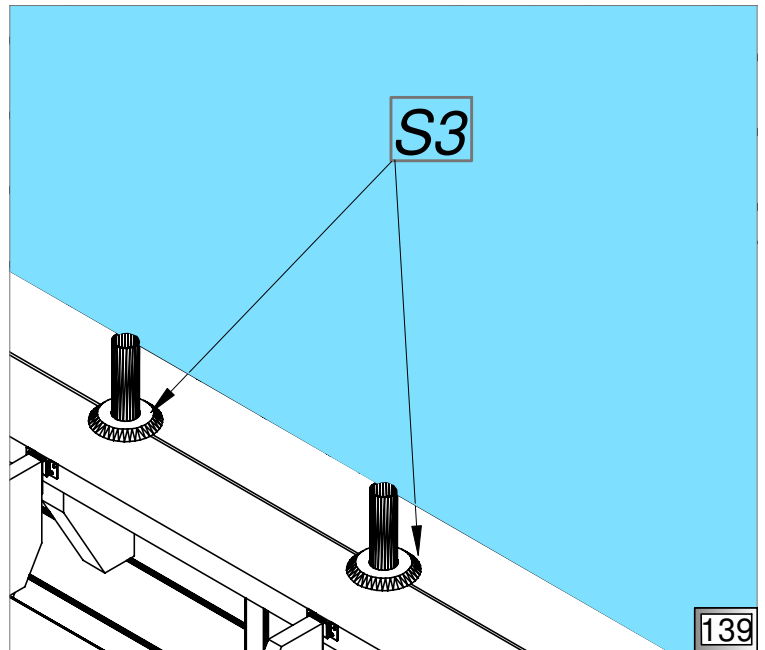
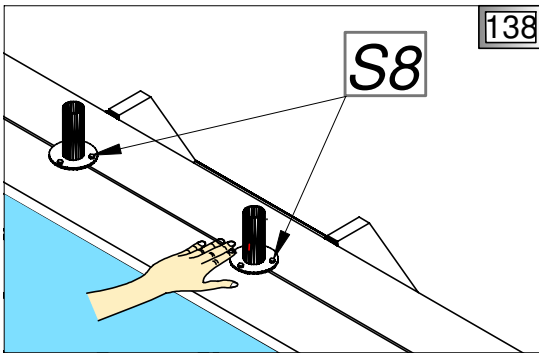
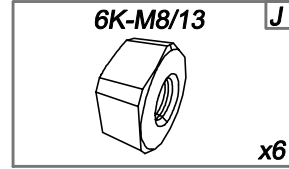
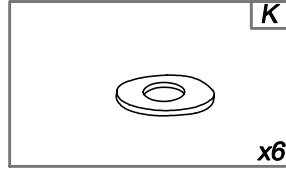
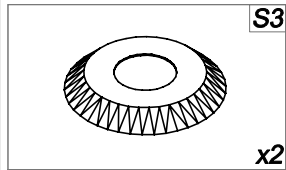
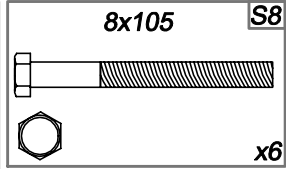
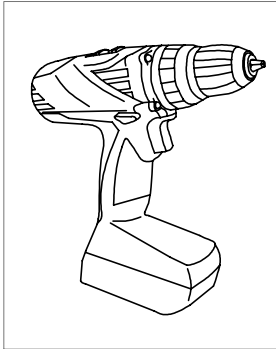
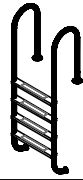

PL Maskownice

GB Corner covers

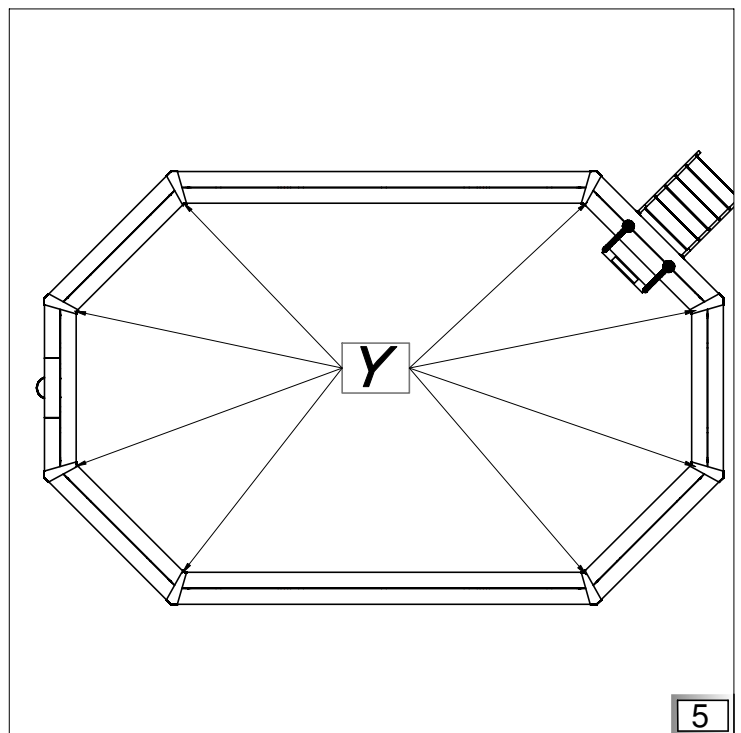
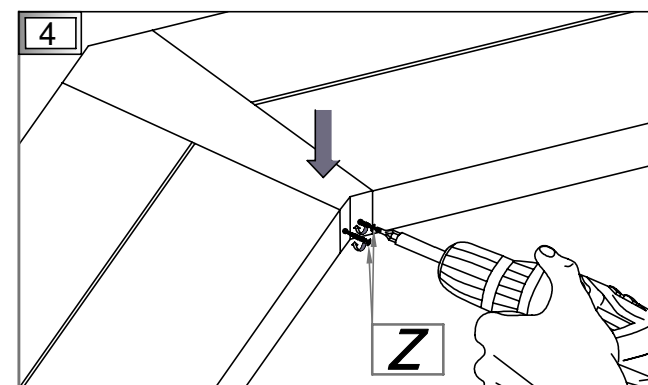
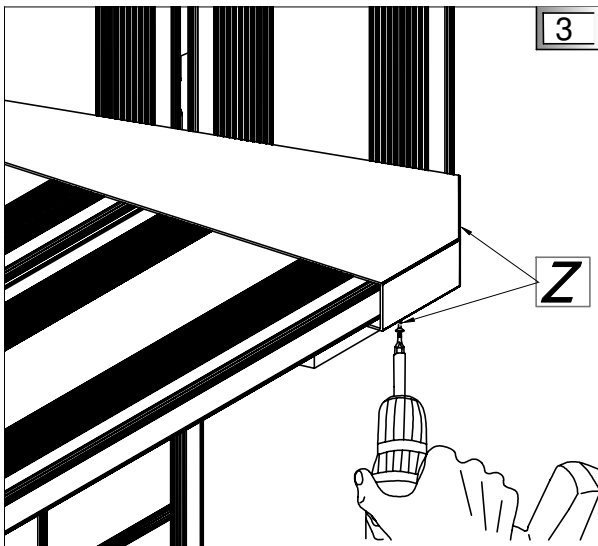
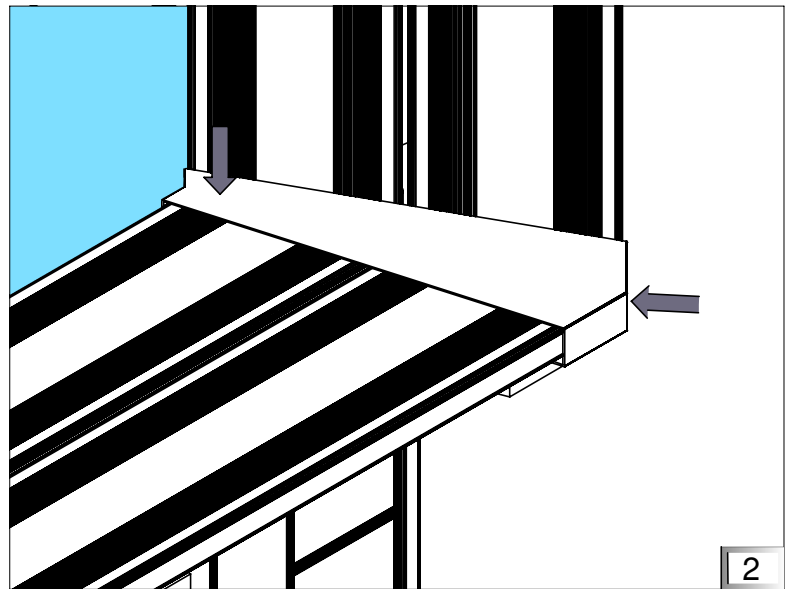
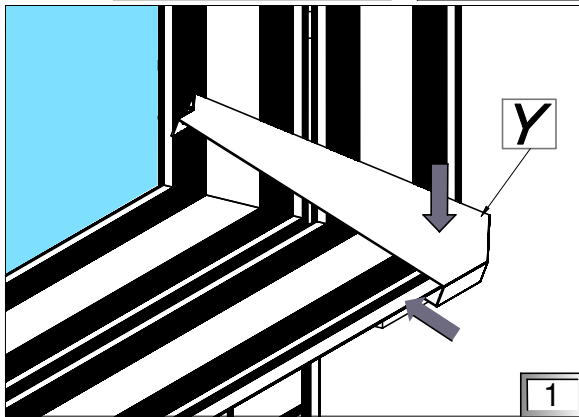
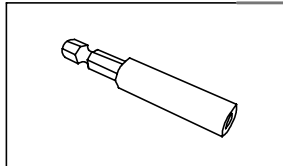
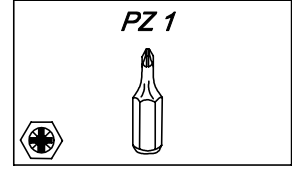
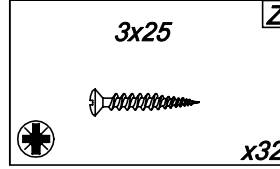
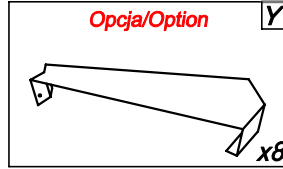
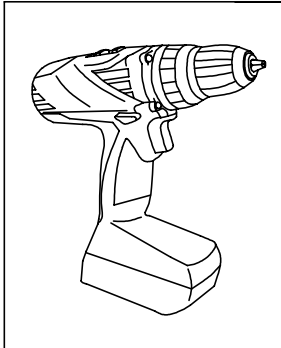

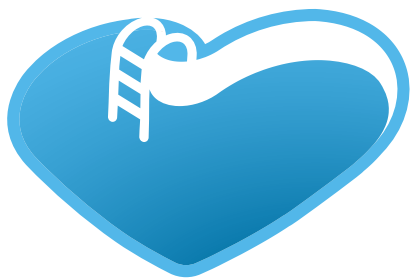

BSVillage

[.com](http://www.bsvillage.com)

PISCINE - WELLNESS - OUTDOOR

www.bsvillage.com

BUSINESS SHOP S.r.l. a Socio Unico
Via della Repubblica n. 19/1 - 42123 Reggio Emilia (RE)
P.Iva e C.F. 02458850357 - Cap. soc. 60.000,00 € i.v.

 www.bsvillage.com

 0522 15 36 417

 info@bsvillage.com

 0522 18 40 494