



BSVillage
PISCINE - WELLNESS - OUTDOOR

MANUALE di MONTAGGIO
Piscina in Legno
EcoWood 486



www.bsvillage.com



BSVillage
.com
PISCINE - WELLNESS - OUTDOOR

BAS44-2

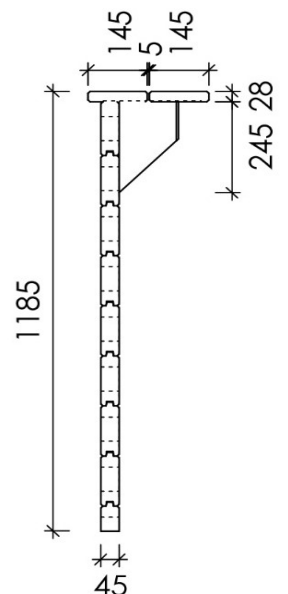
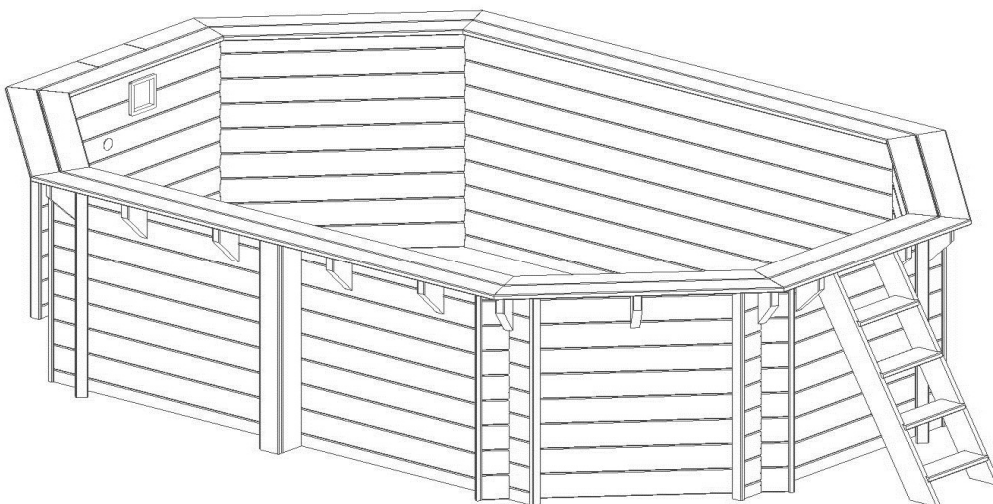
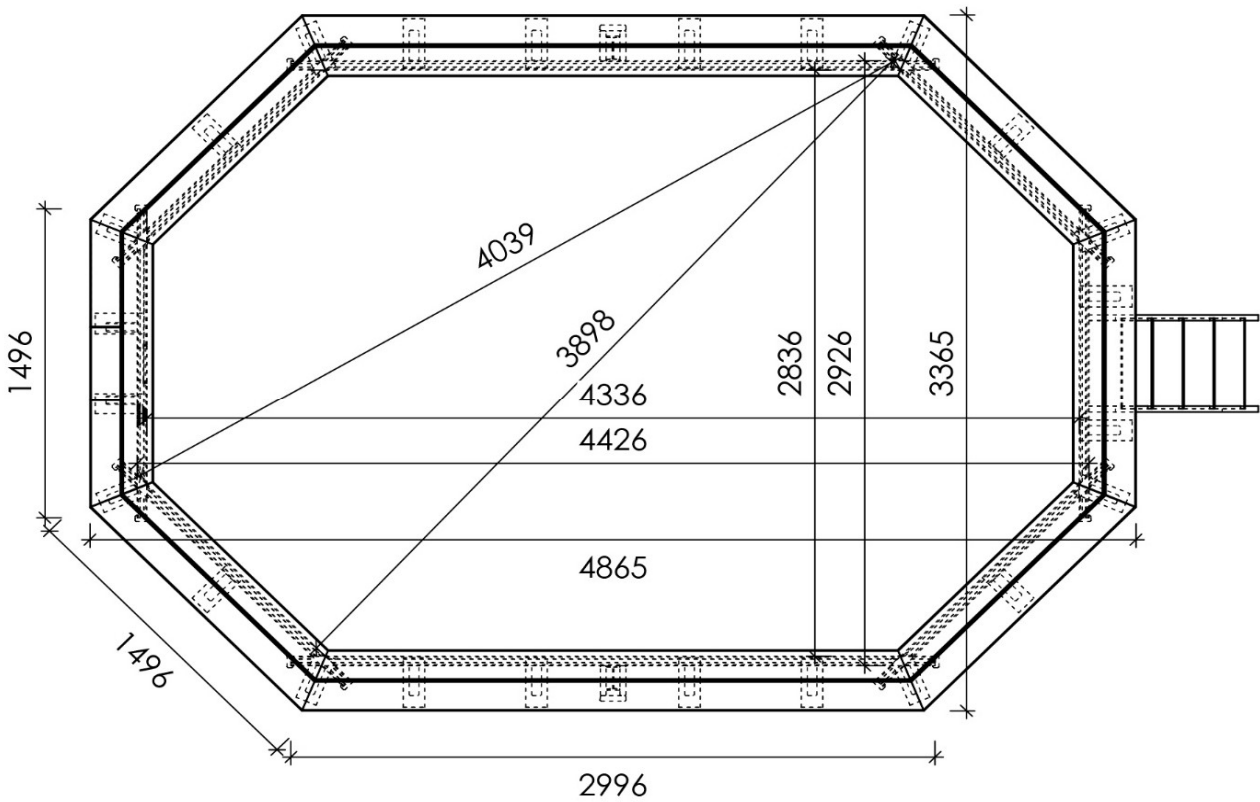
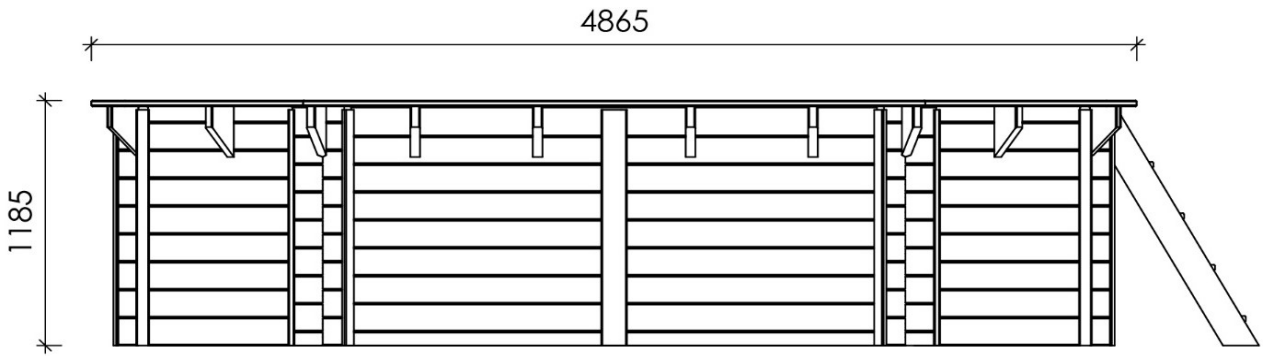

PRACTICAL ADVICE

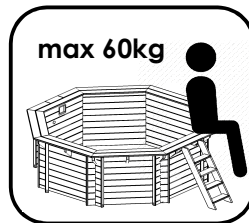
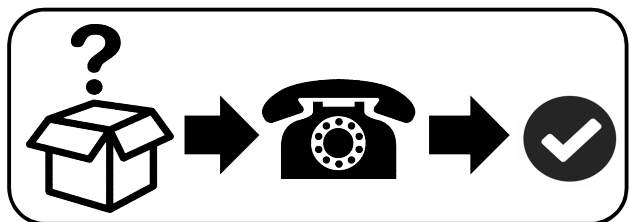
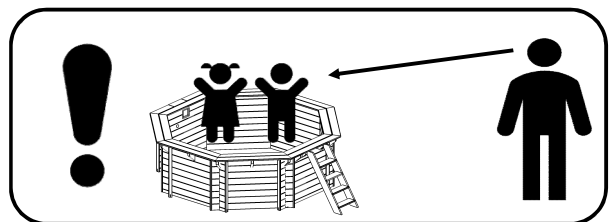
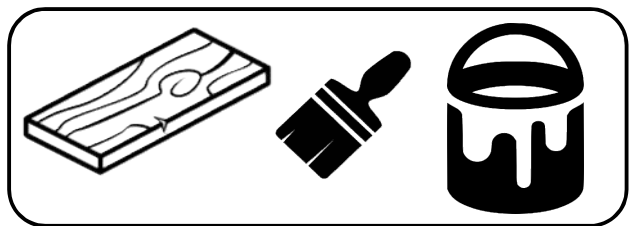
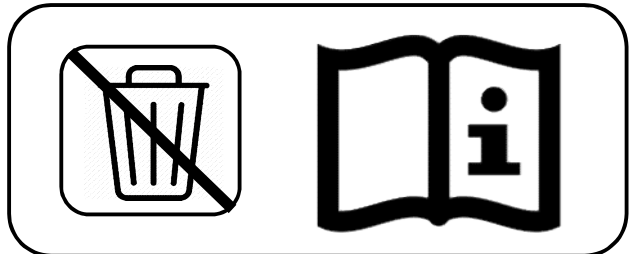
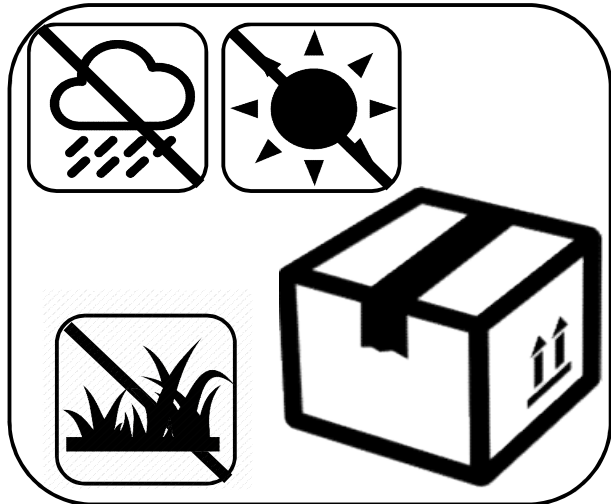
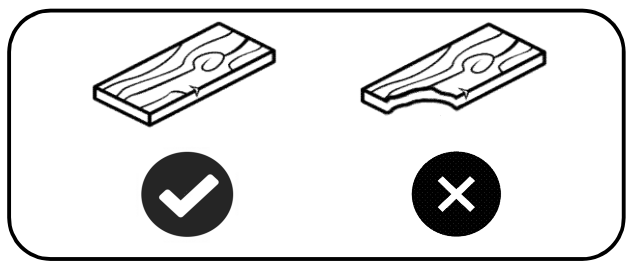
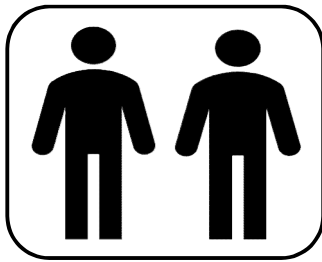



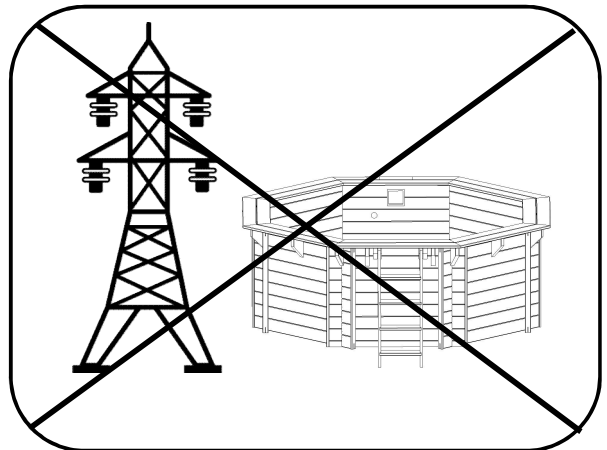
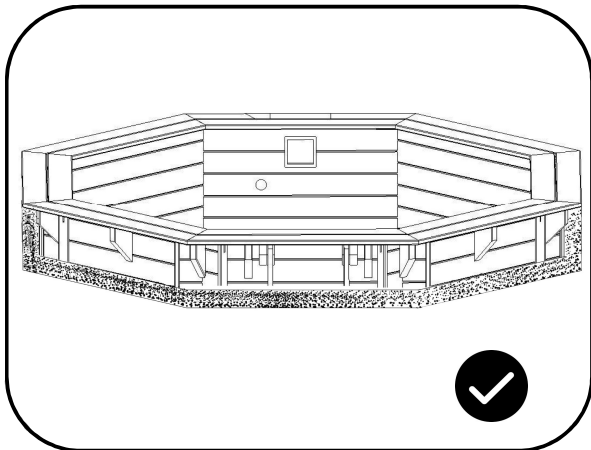
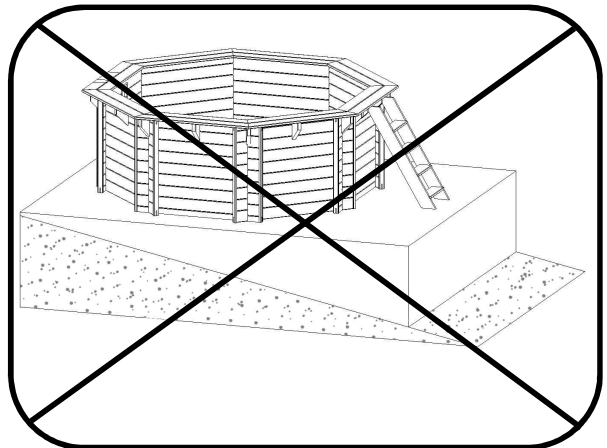
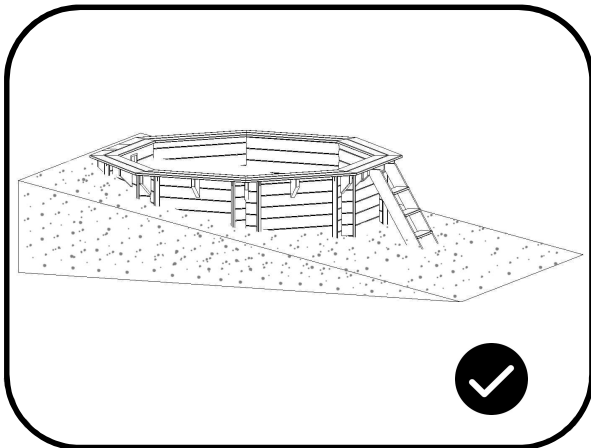
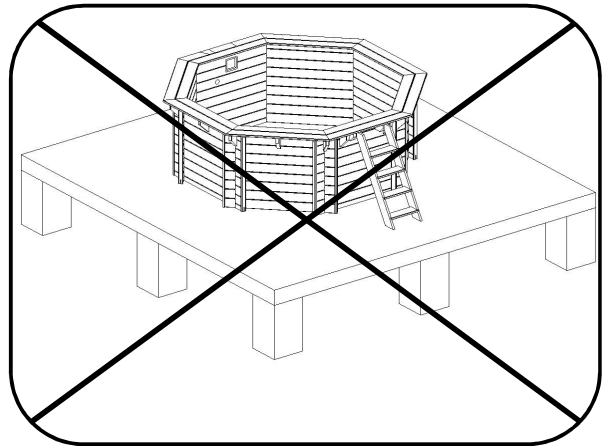
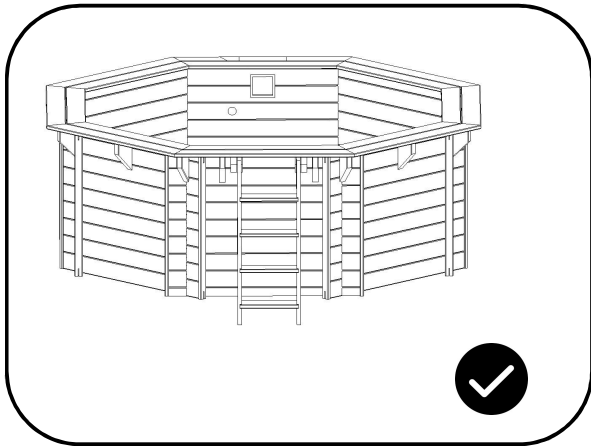







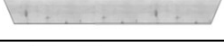





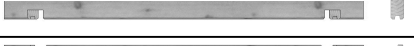
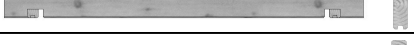
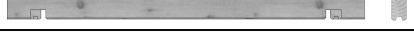



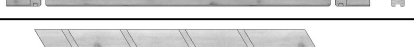
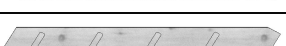

BASE



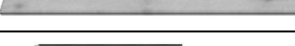

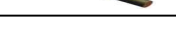





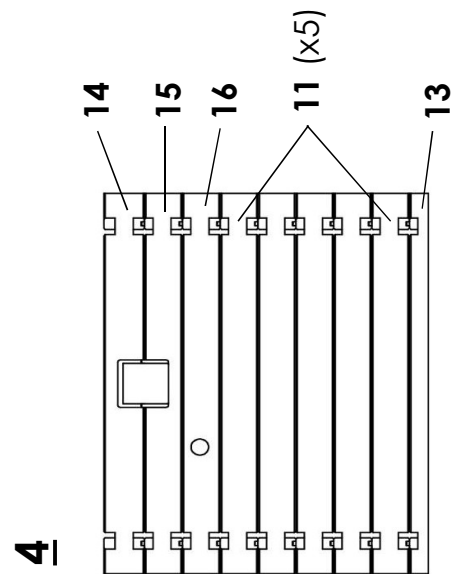
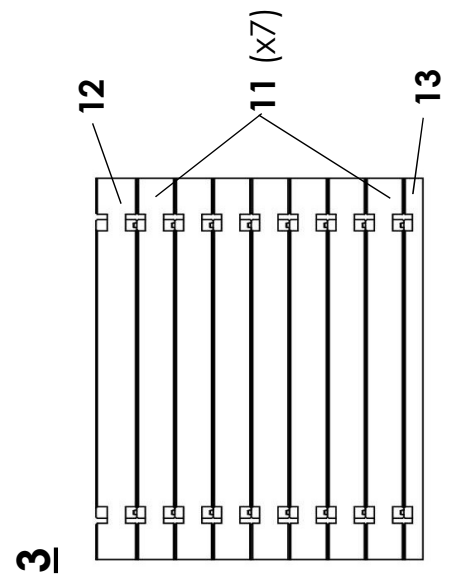
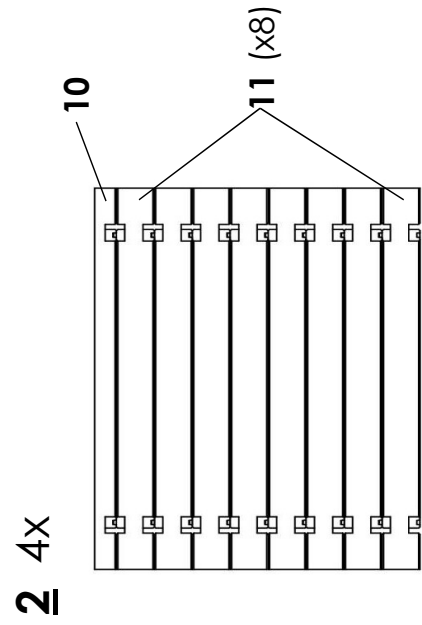
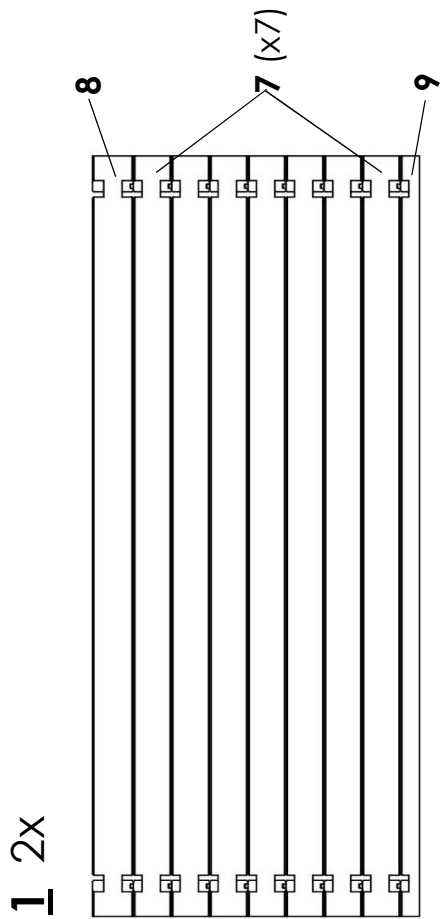
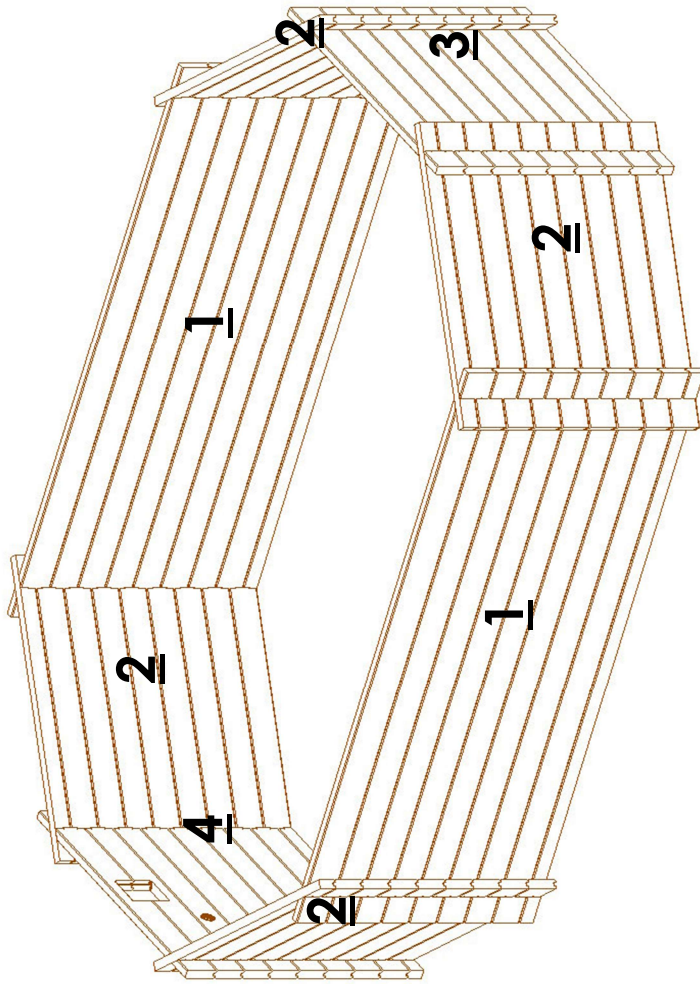

BAS44-2

A B

1		28	145	2893	2		
2		28	145	2769	2		
3		28	145	1393	5		
4		28	145	1269	6		
5		28	145	517	2		
6		28	145	350	1		
7		45	145	2996	14		
8		45	145	2996	2		
9		45	78	2996	2		
10		45	77	1496	4		
11		45	145	1496	44		
12		45	145	1496	1		
13		45	78	1496	2		
14		45	145	1496	1		
15		45	145	1496	1		
16		45	145	1496	1		
17		28	145	1388	1		
18		28	145	1388	1		
19		28	145	440	4		
20		45	145	245	16		
21		45	145	245	8		
22		28	60	1140	16		
23		28	145	1140	4		
24		28	120	1140	2		
25		58	120	1700	2		
26		Ø10		500	2		





A		3,0x25	12		
B		3,5x25	308		
C		5x80	32		
D		4,5x60	58		
E		5x100	68		
F		3x100x240	24		
G			2		
H		40x40	2		
J		1250	11		
K		4x40	70		

M	 BC1517	POOL STEPS INOX	1		
N		WATER HOSE	1		
P		RETURN INLET	1		
Q		FILTER	1		
R		SAND	1		
S		SKIMMER	1		
T		FLOOR MAT	1		
U		FOIL-LAINER	1		
W		DOUBLE SIDE TAPE	1		



TOOLS

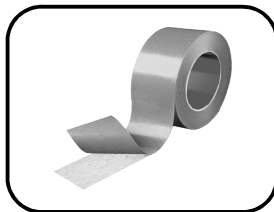
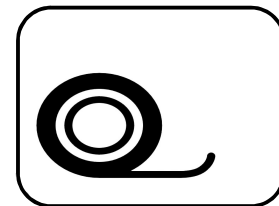
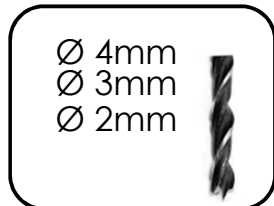
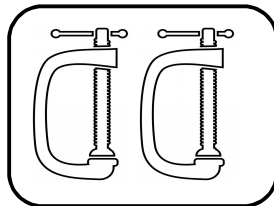
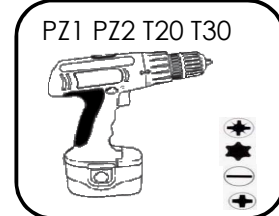
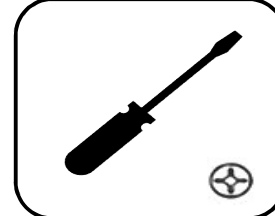
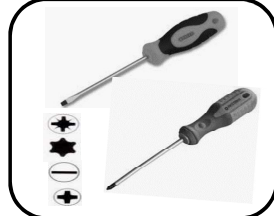
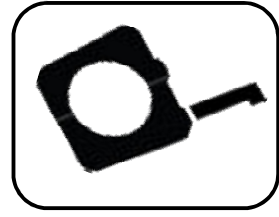
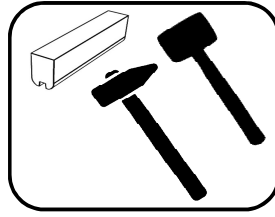
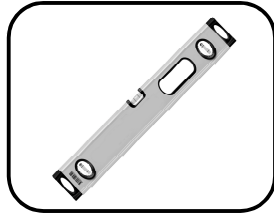
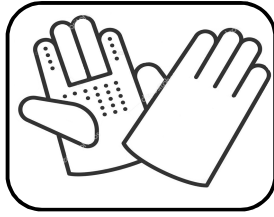

FOUNDATION

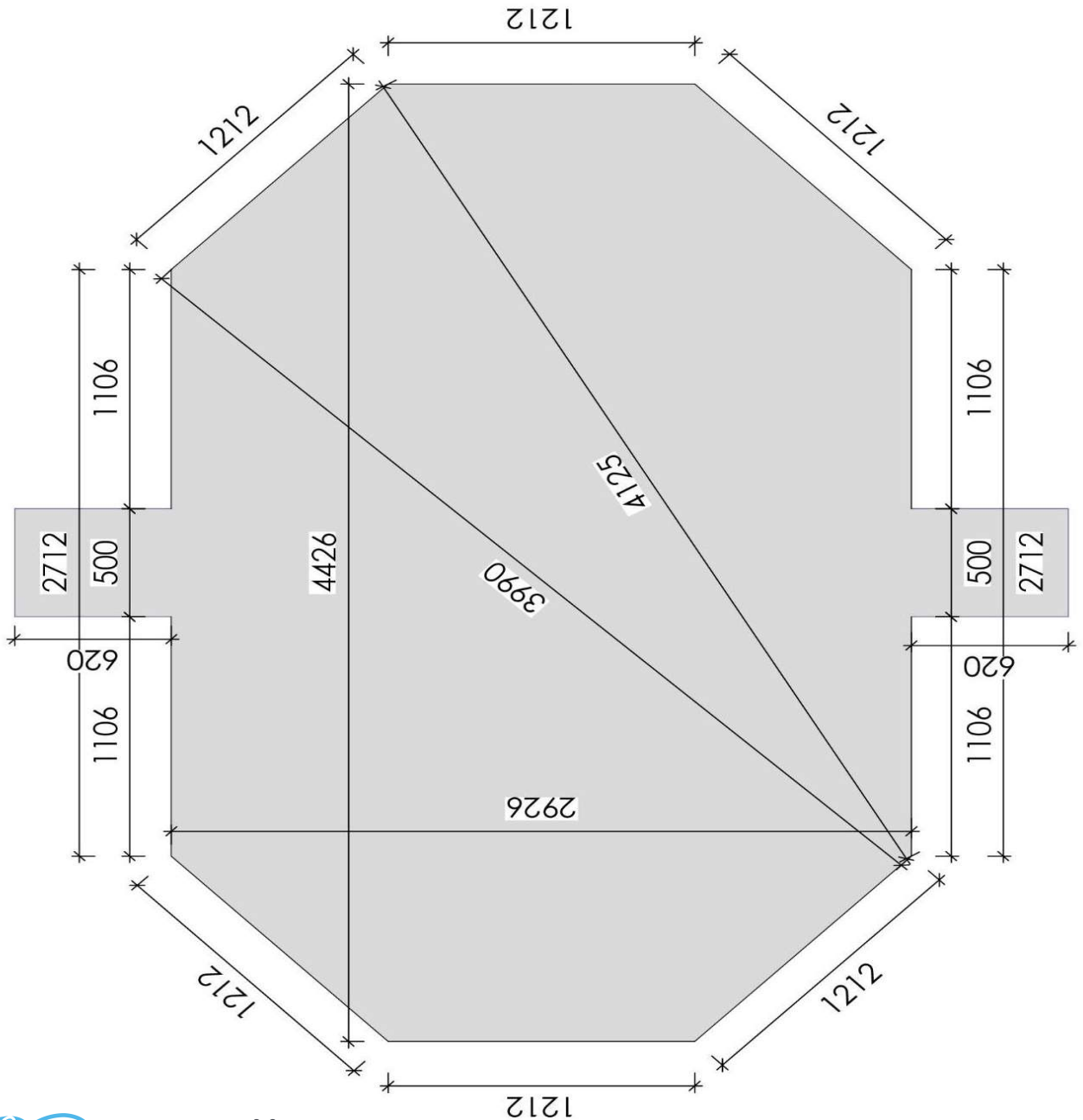
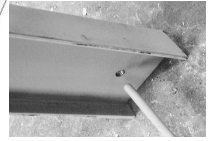
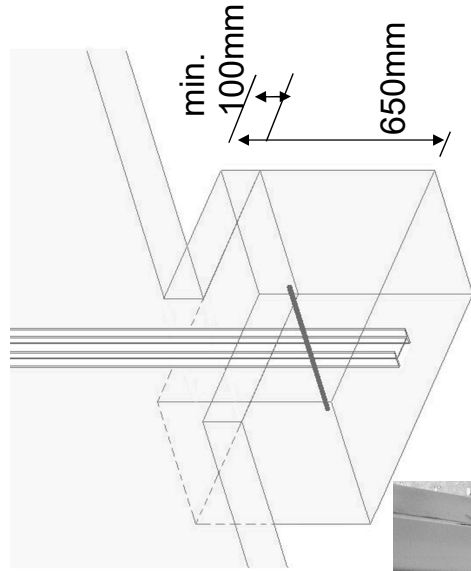
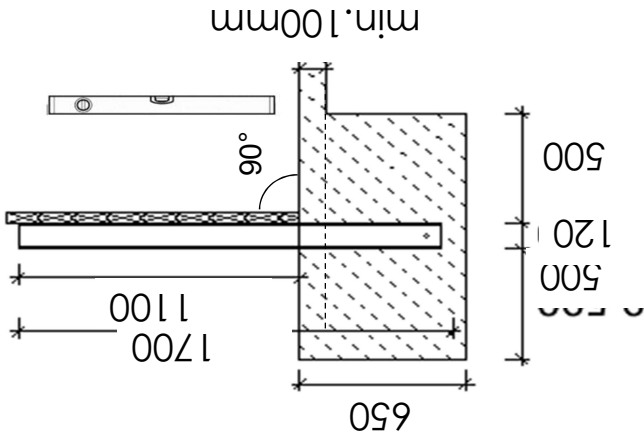

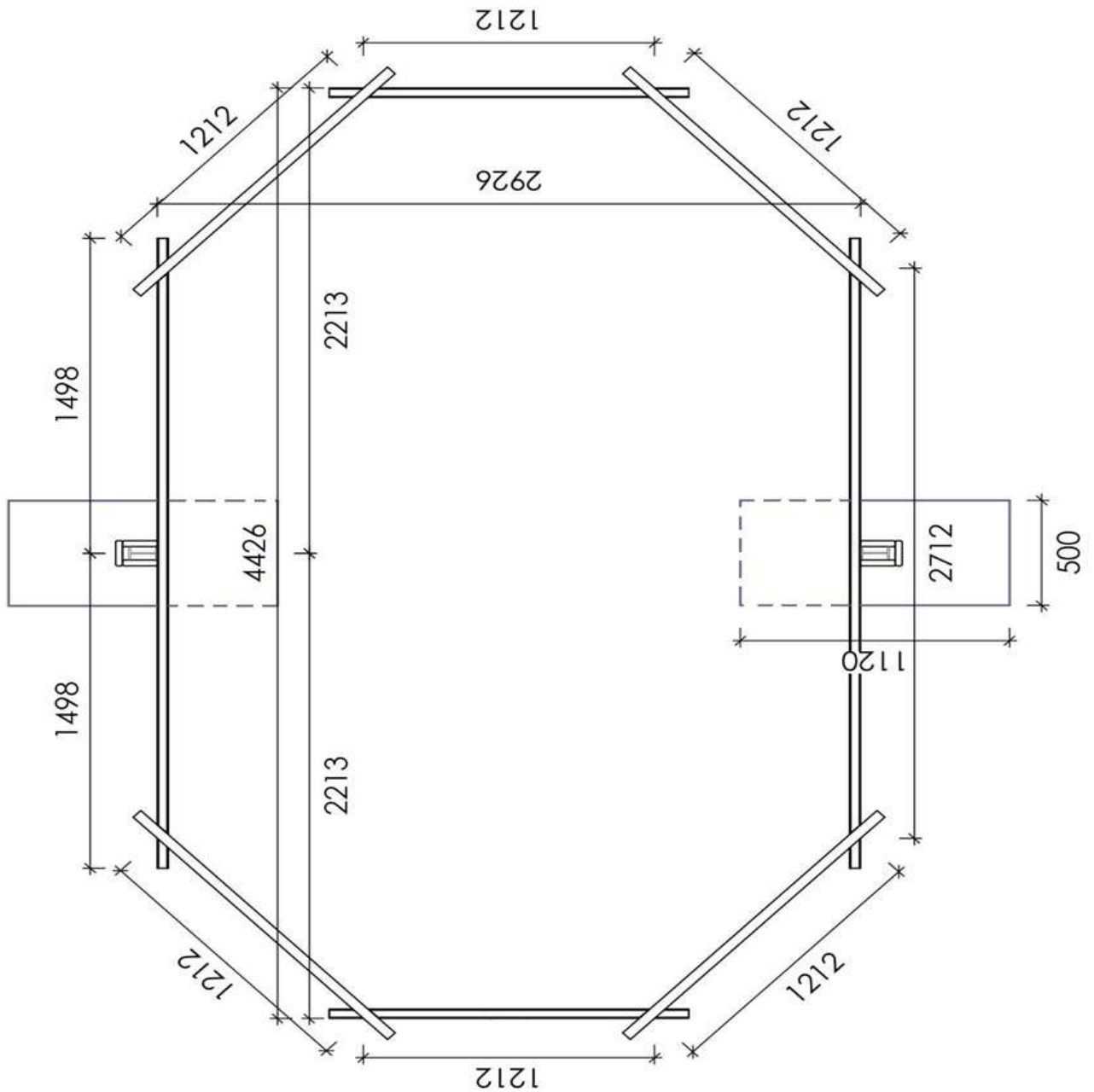
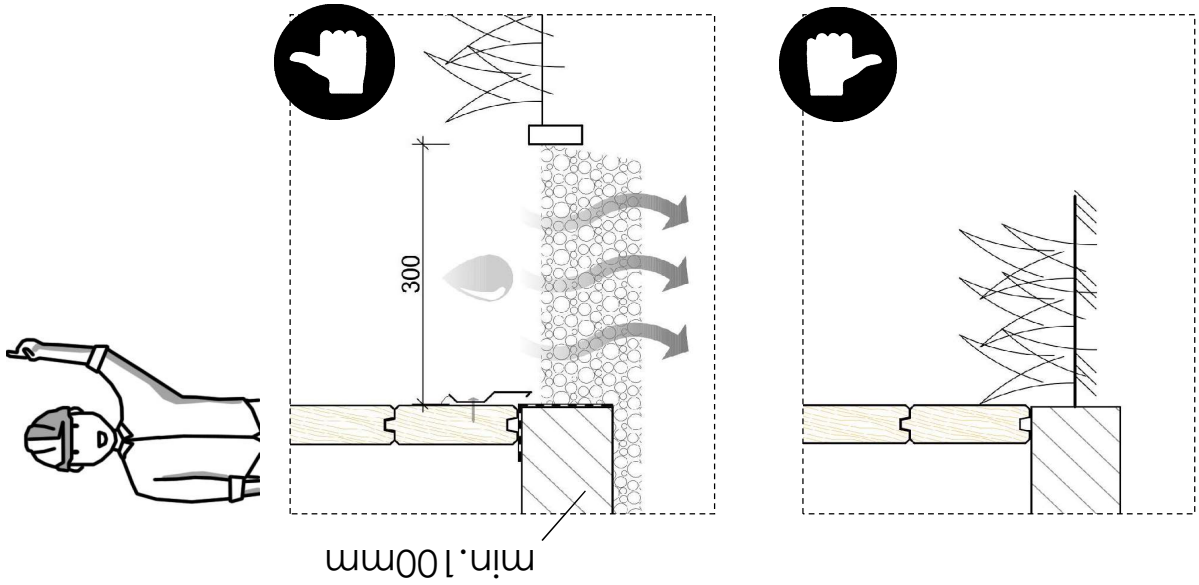

MONTAGE

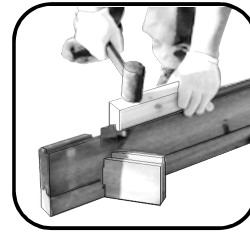
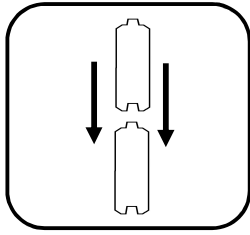
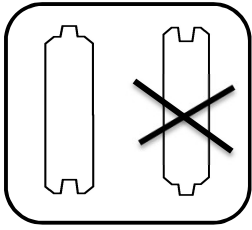

step I

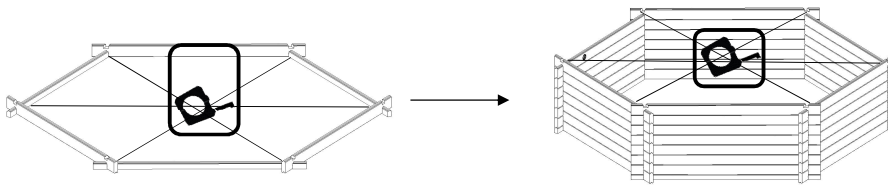
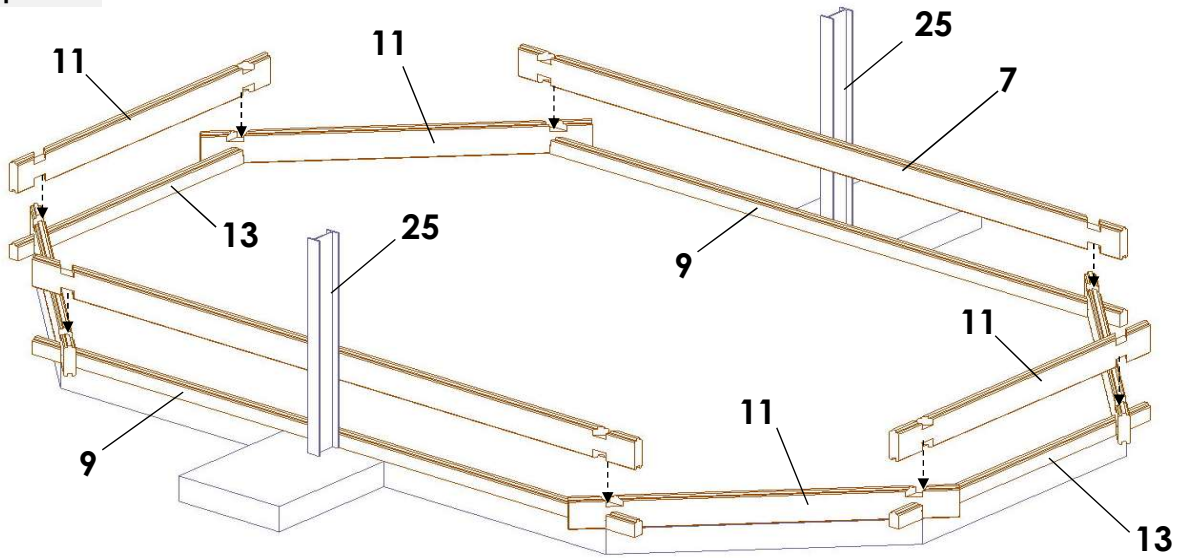

step II

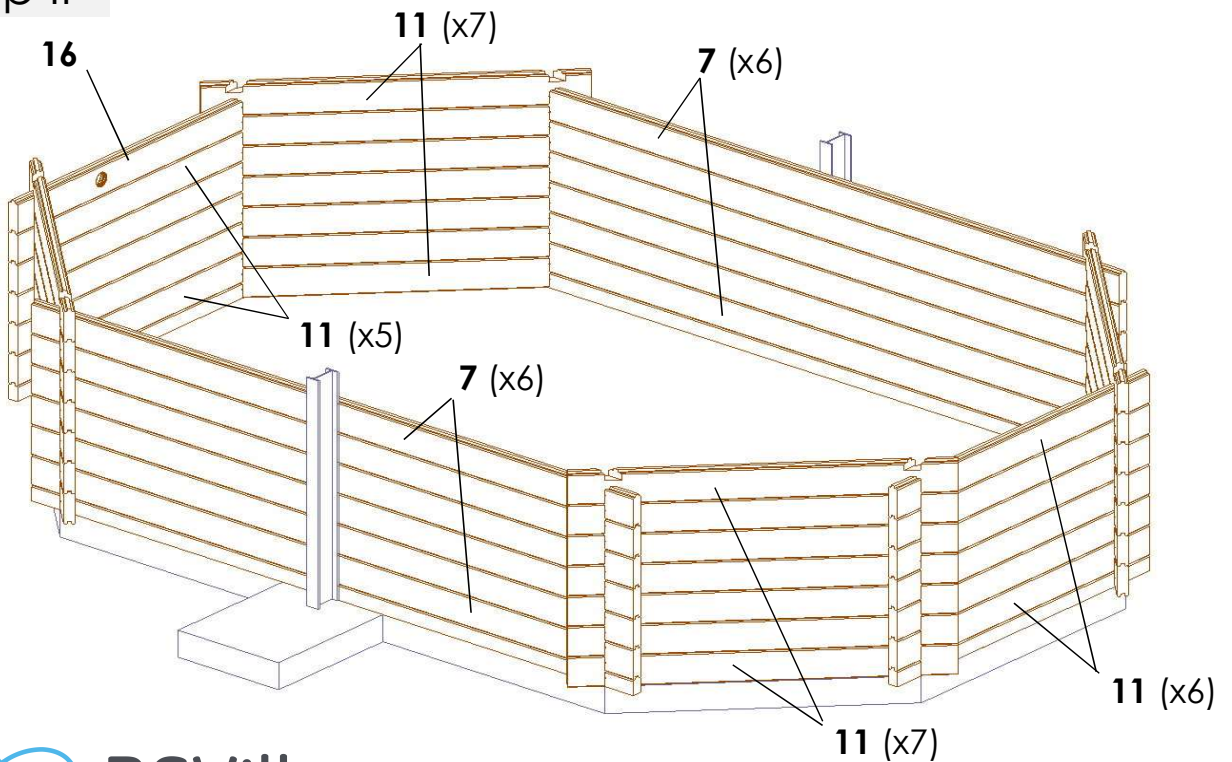

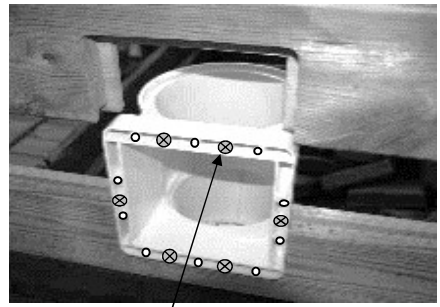
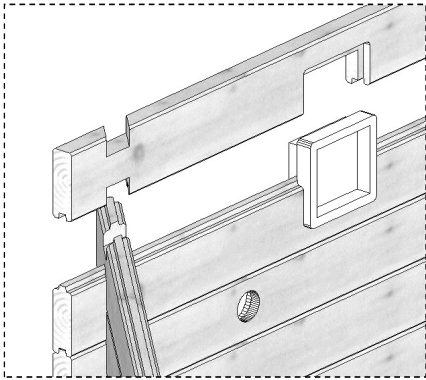

Ø4,0x40 (x6)

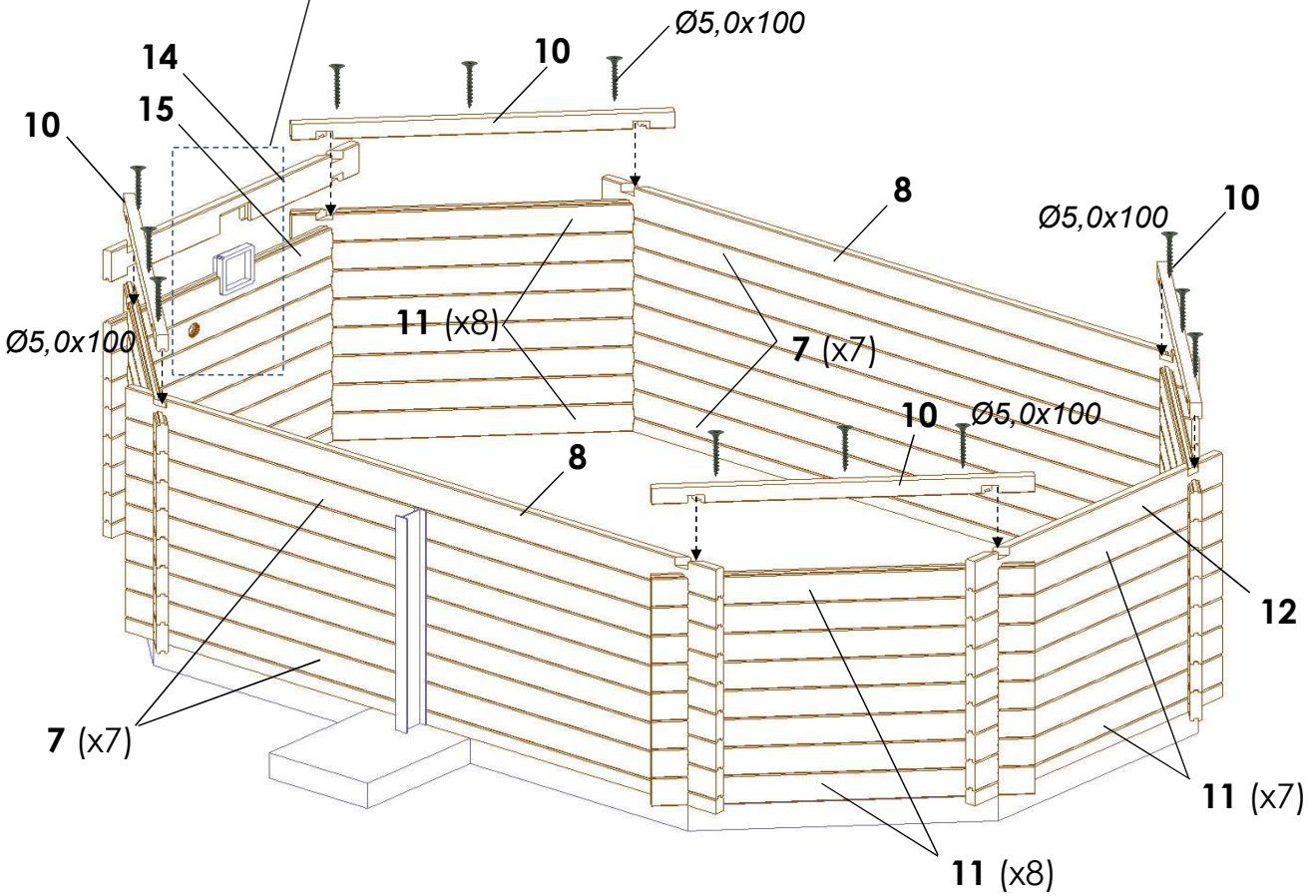

step IV

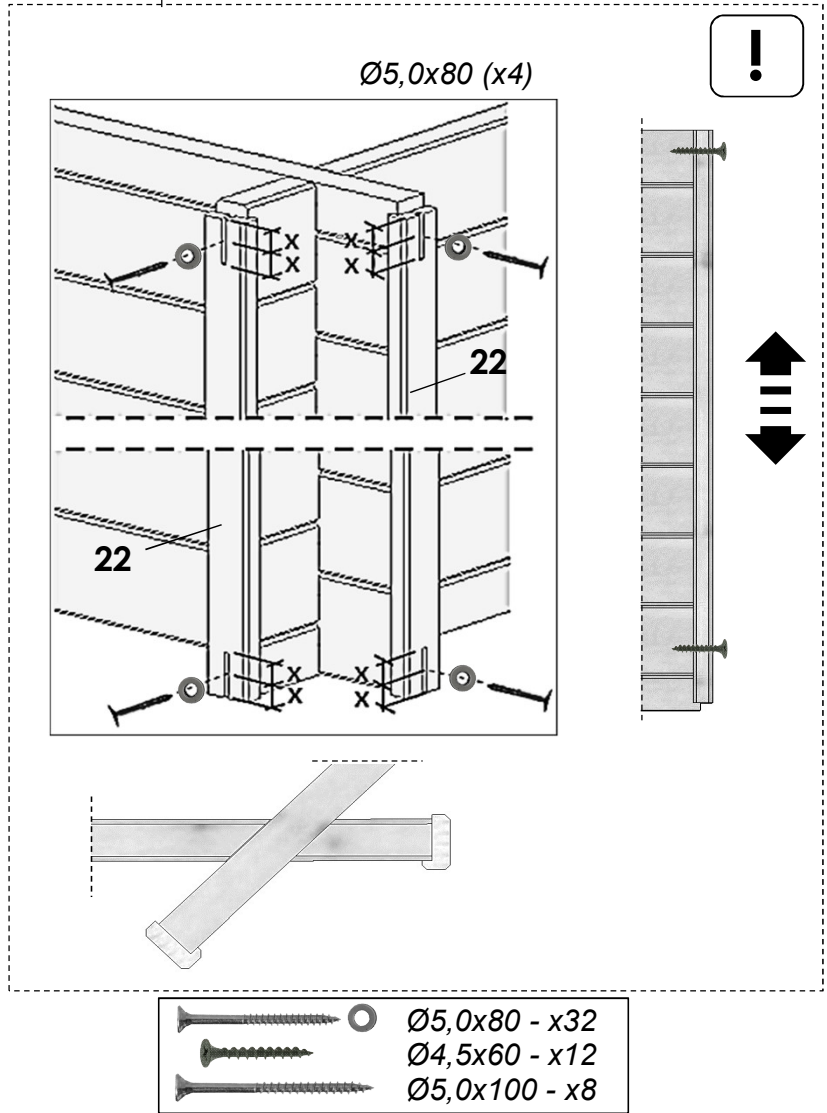
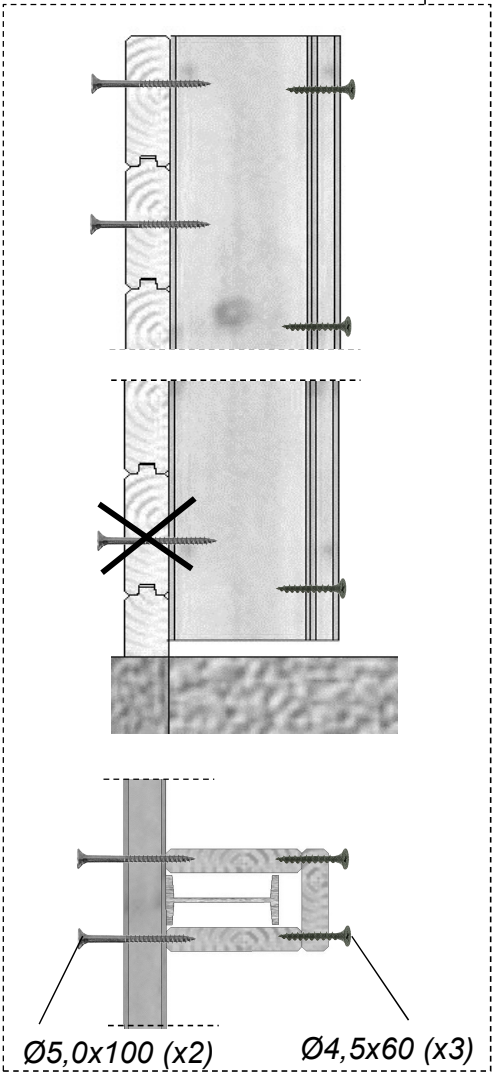
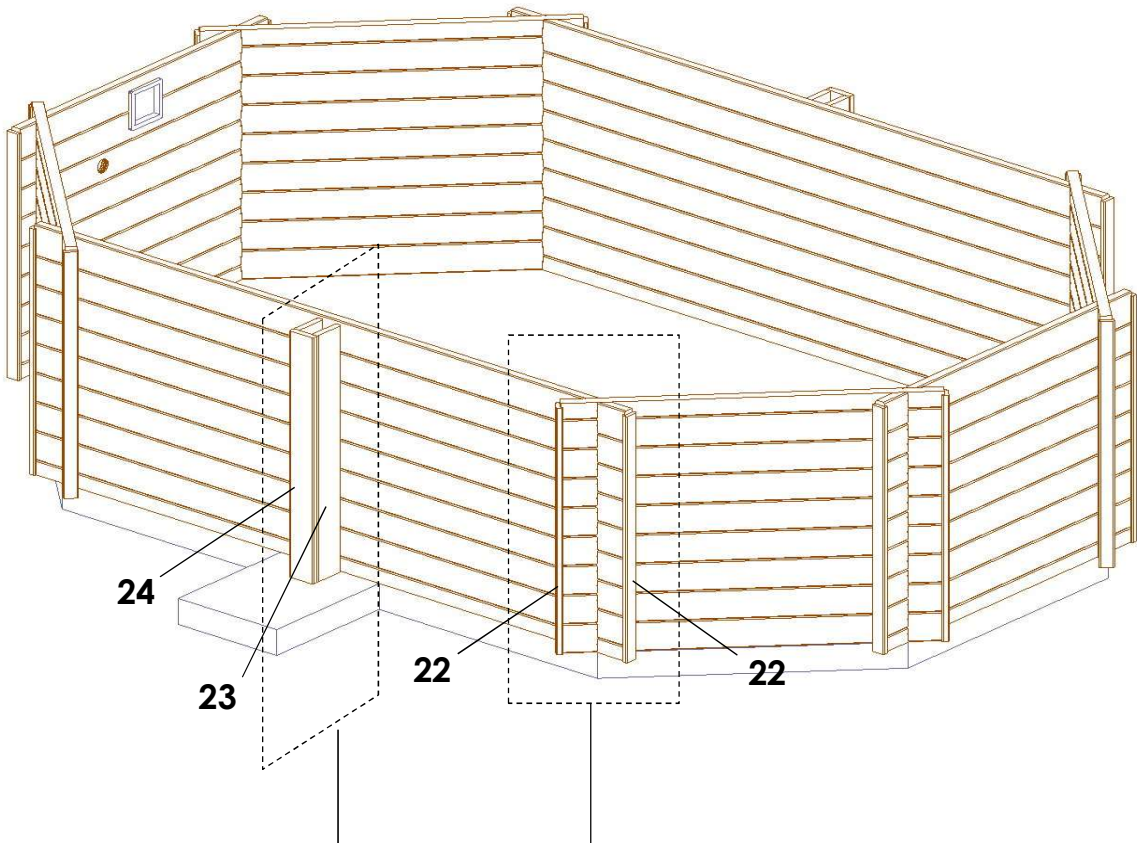

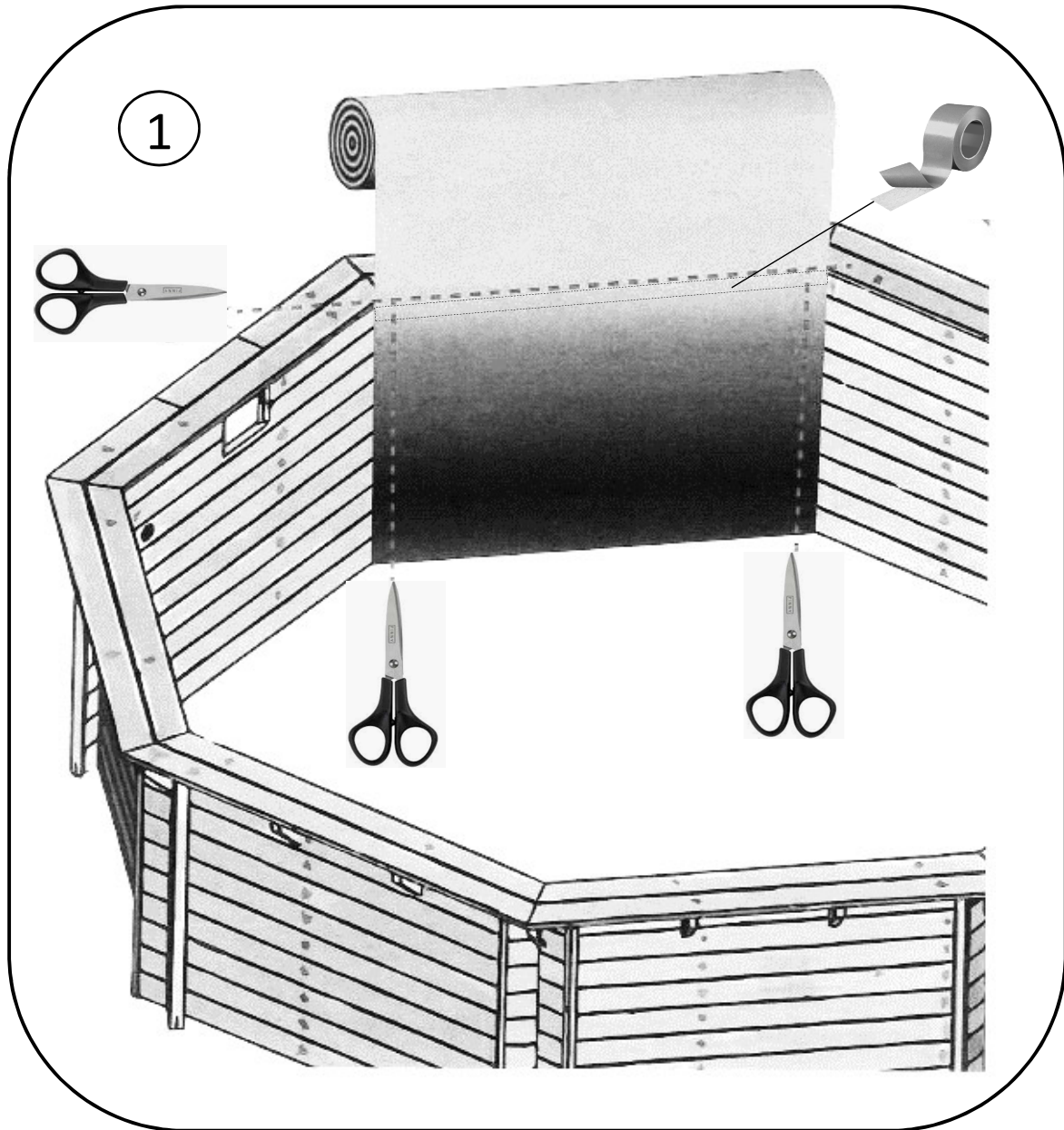
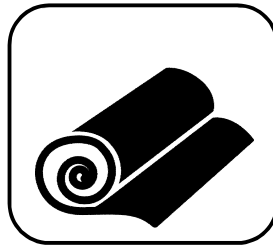

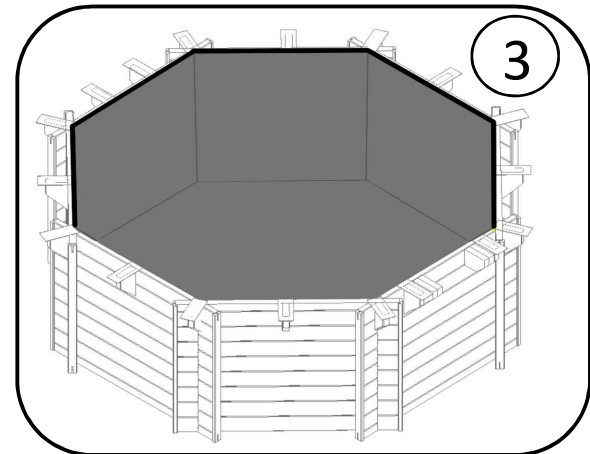
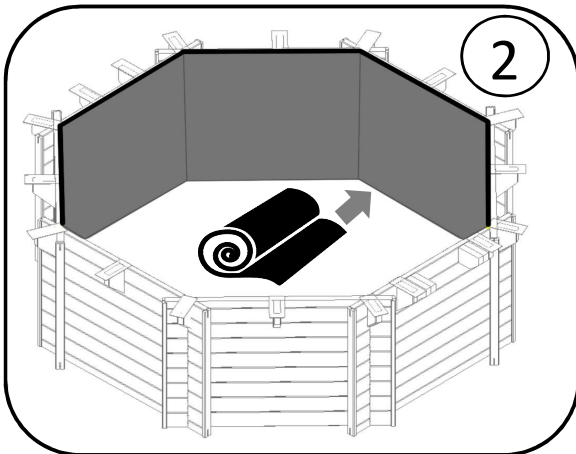
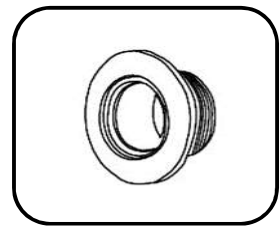
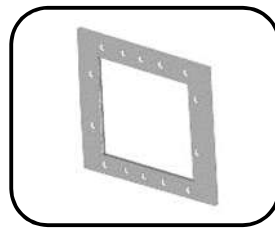
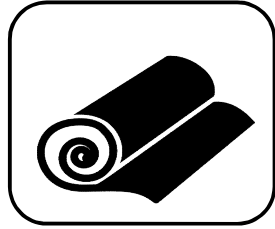
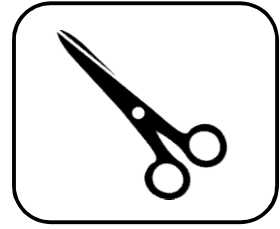
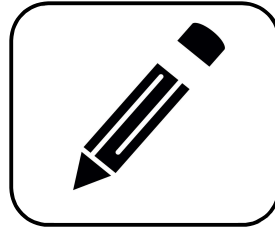

liner profiles montage

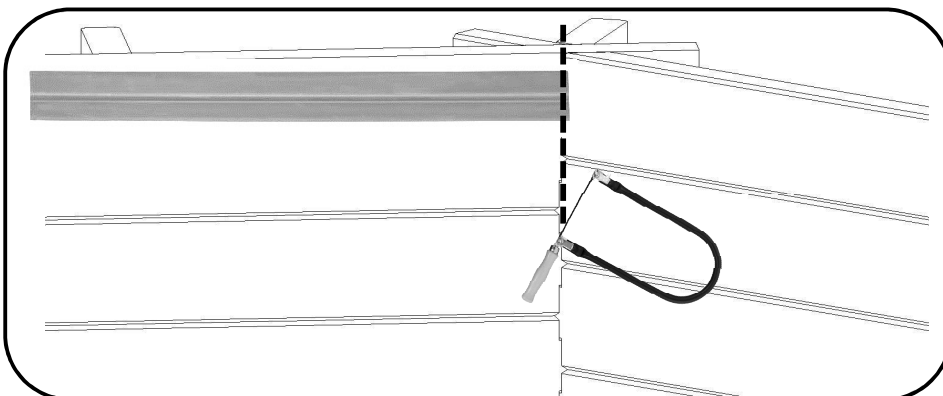
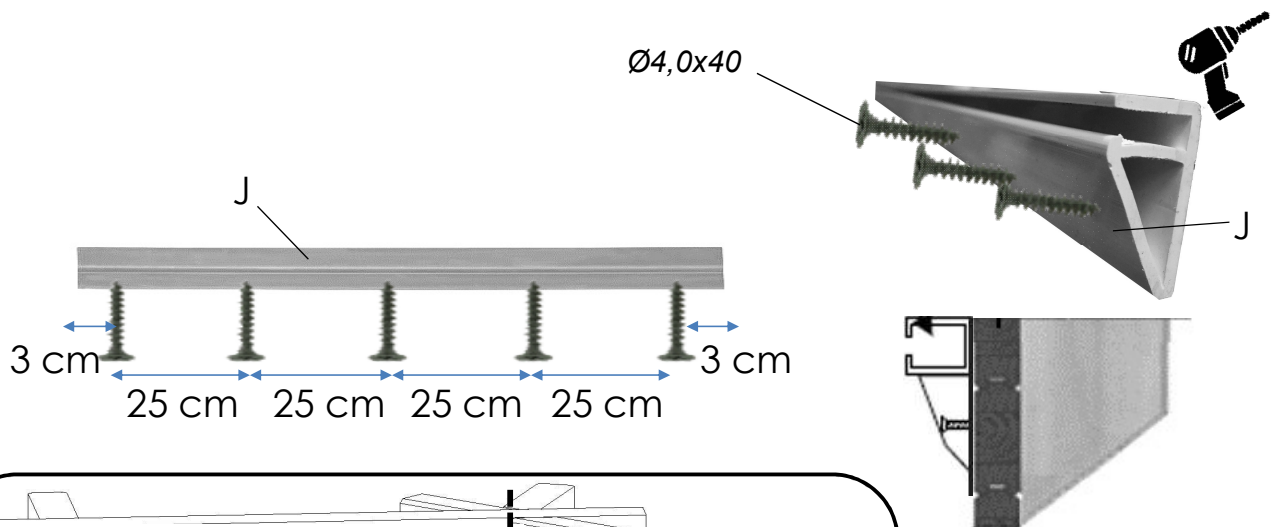

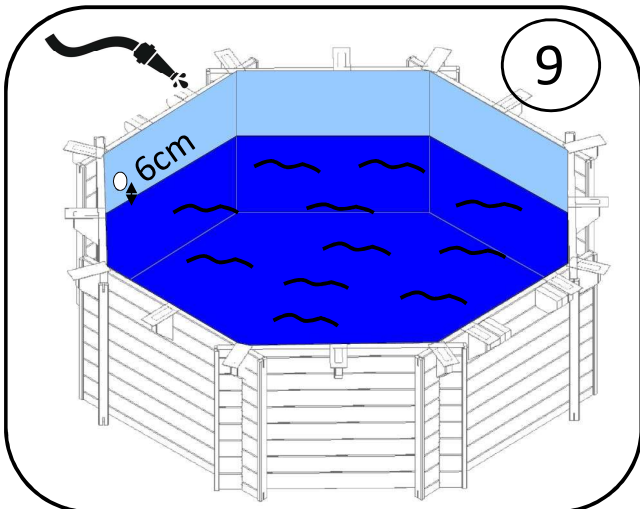
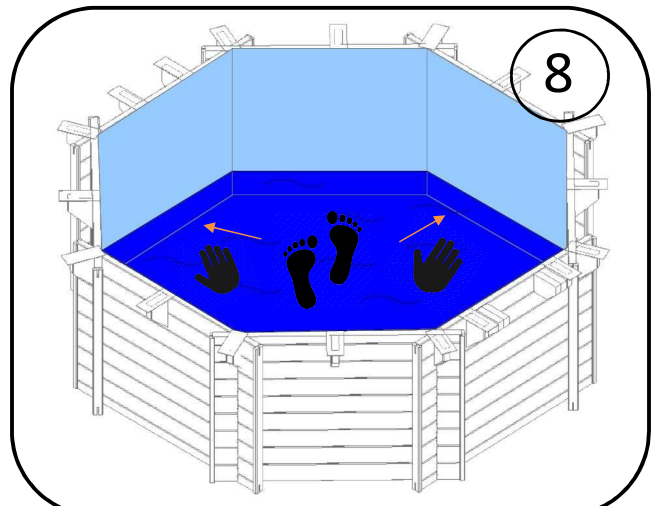
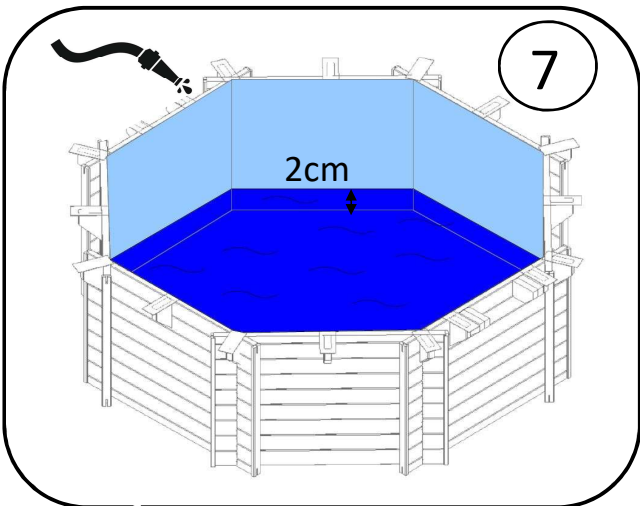
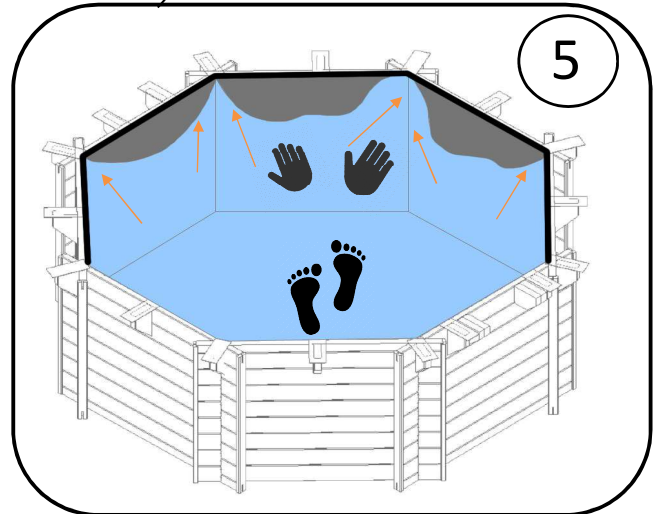
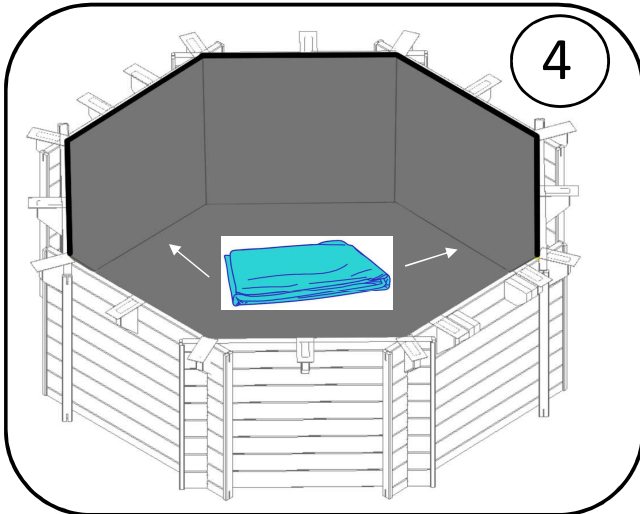
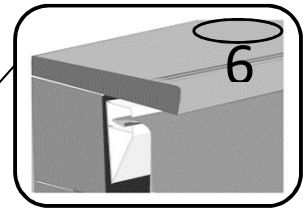
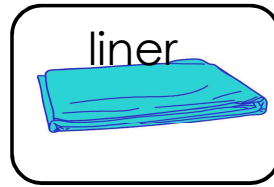
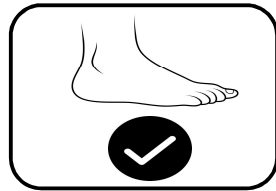
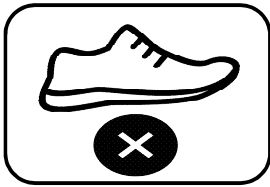

10

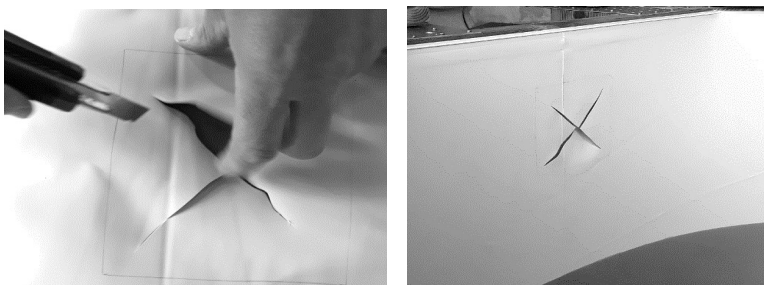
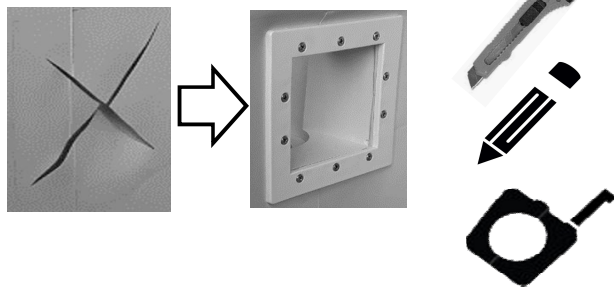

11

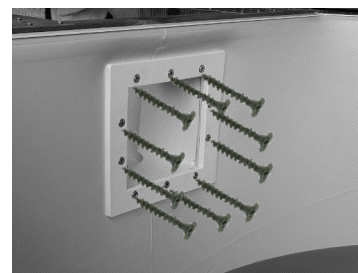

Ø4,0x40 (x10)



return inlet montage

inside

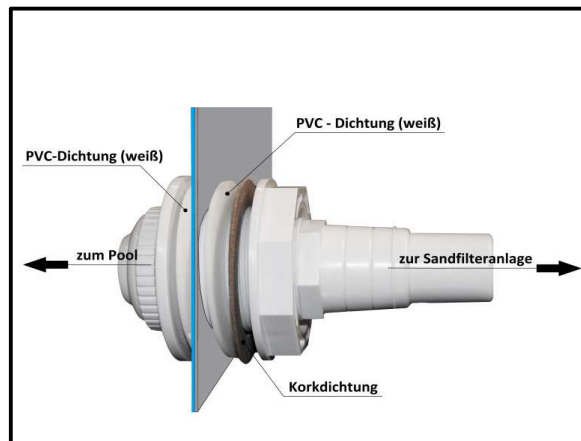
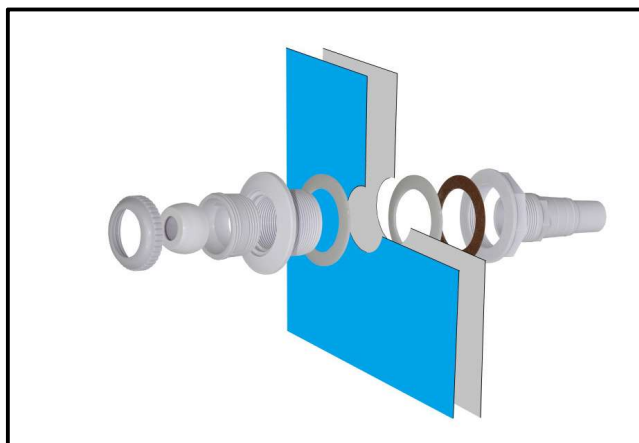
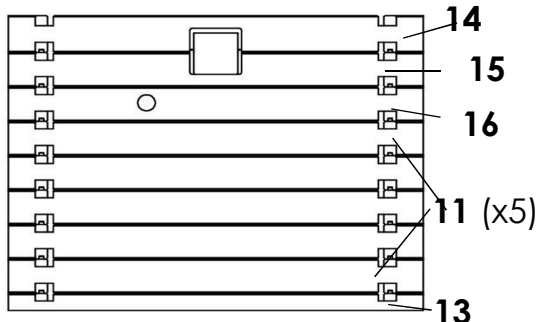

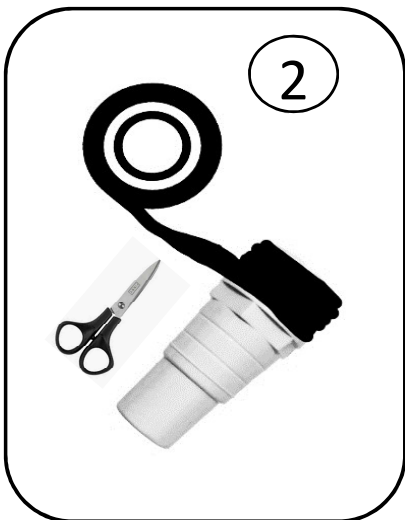
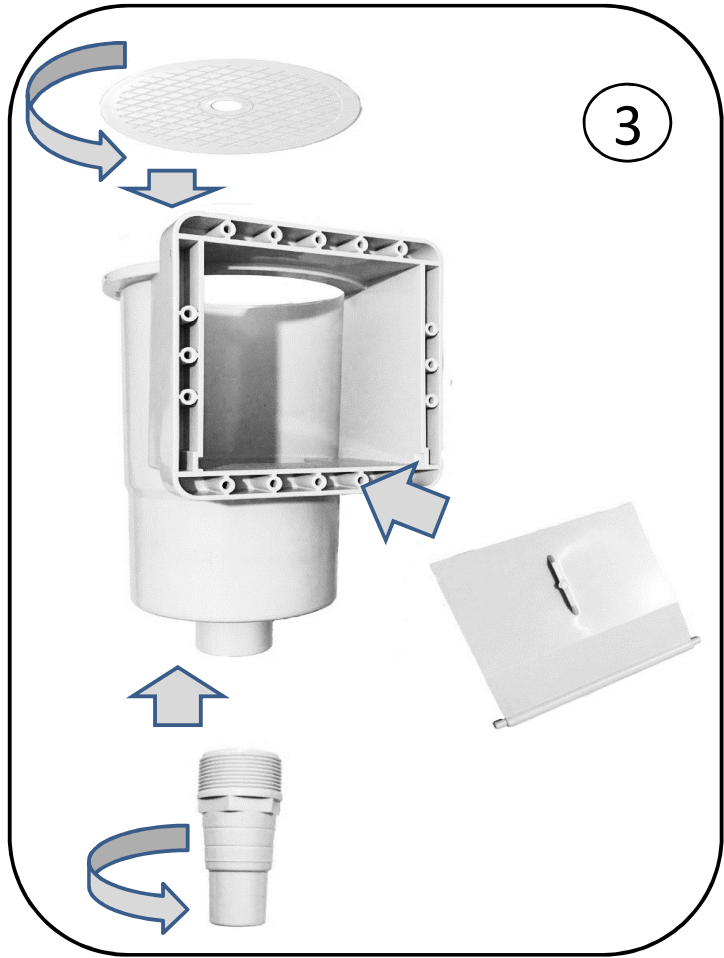
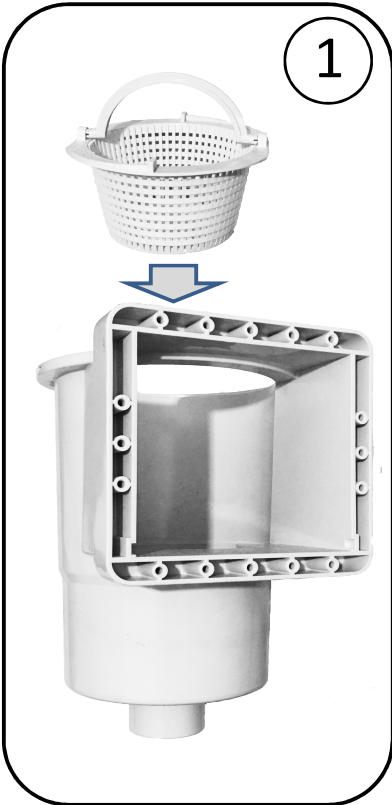
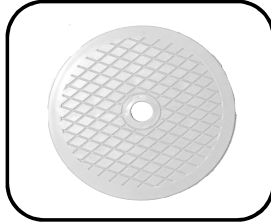
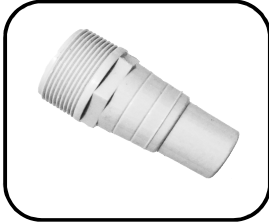
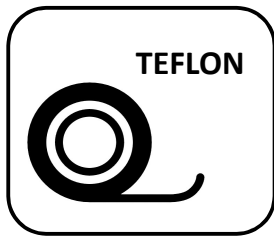

step V

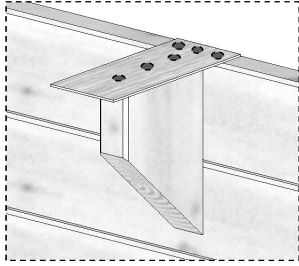

Ø3,5x25 (x6)

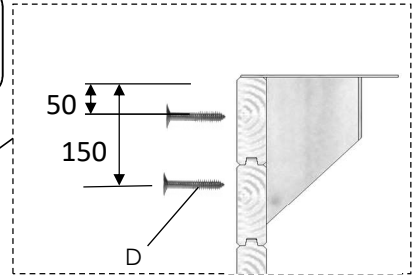
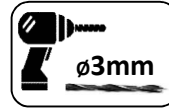

Ø5,0x100 (x2)

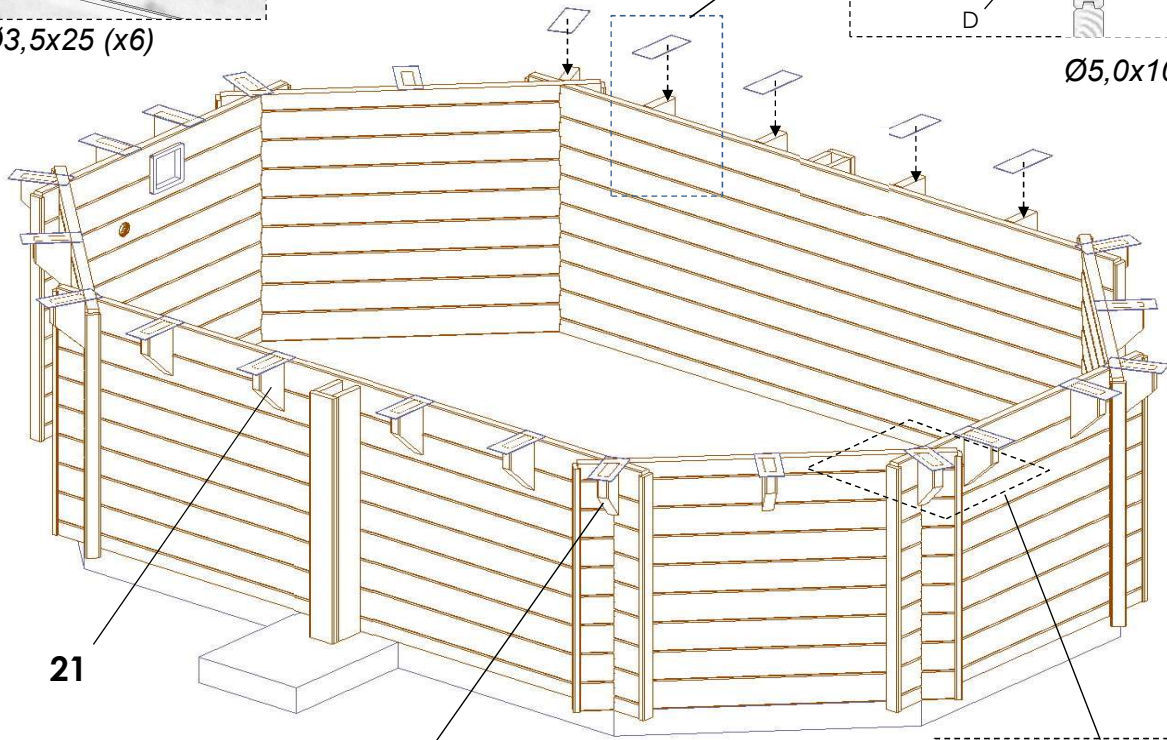

21

20

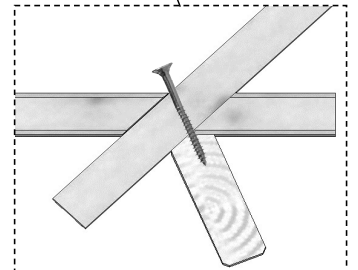
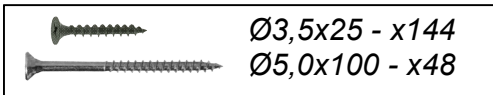

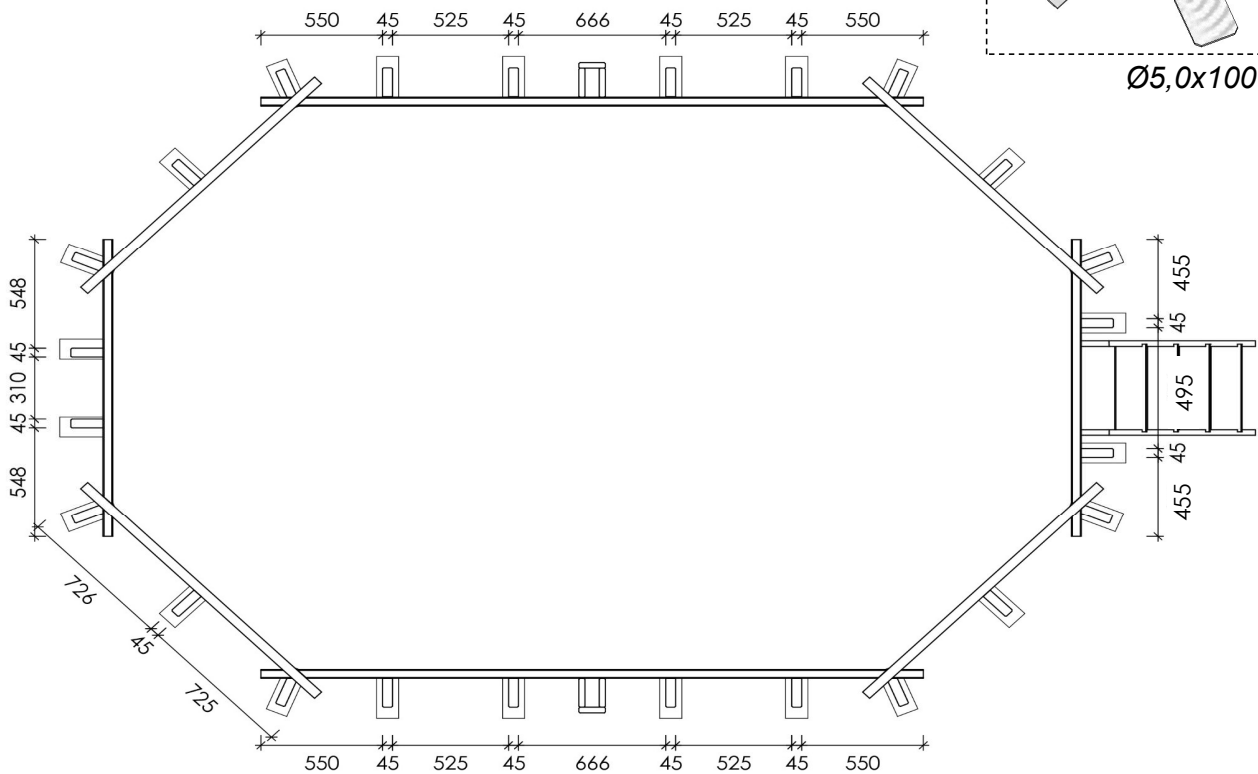

Ø5,0x100 (x2)

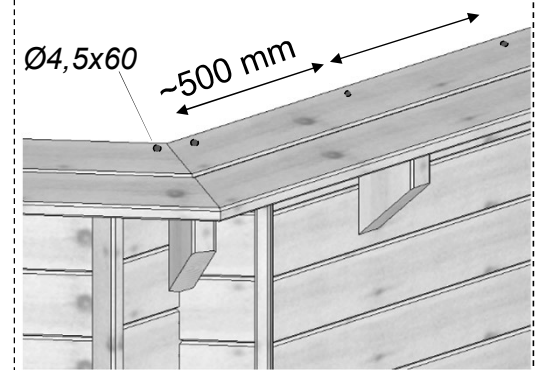
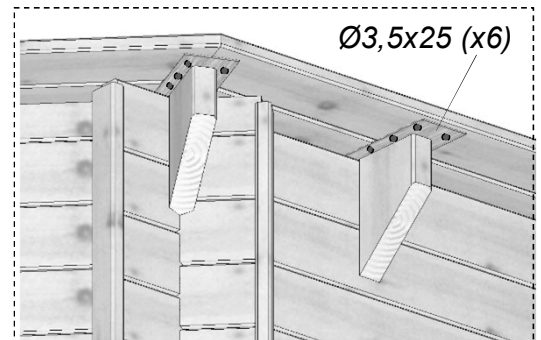
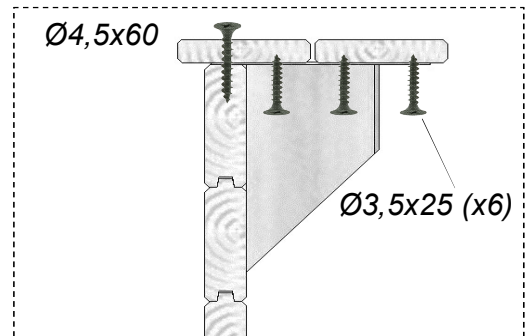
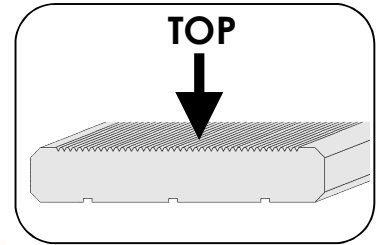
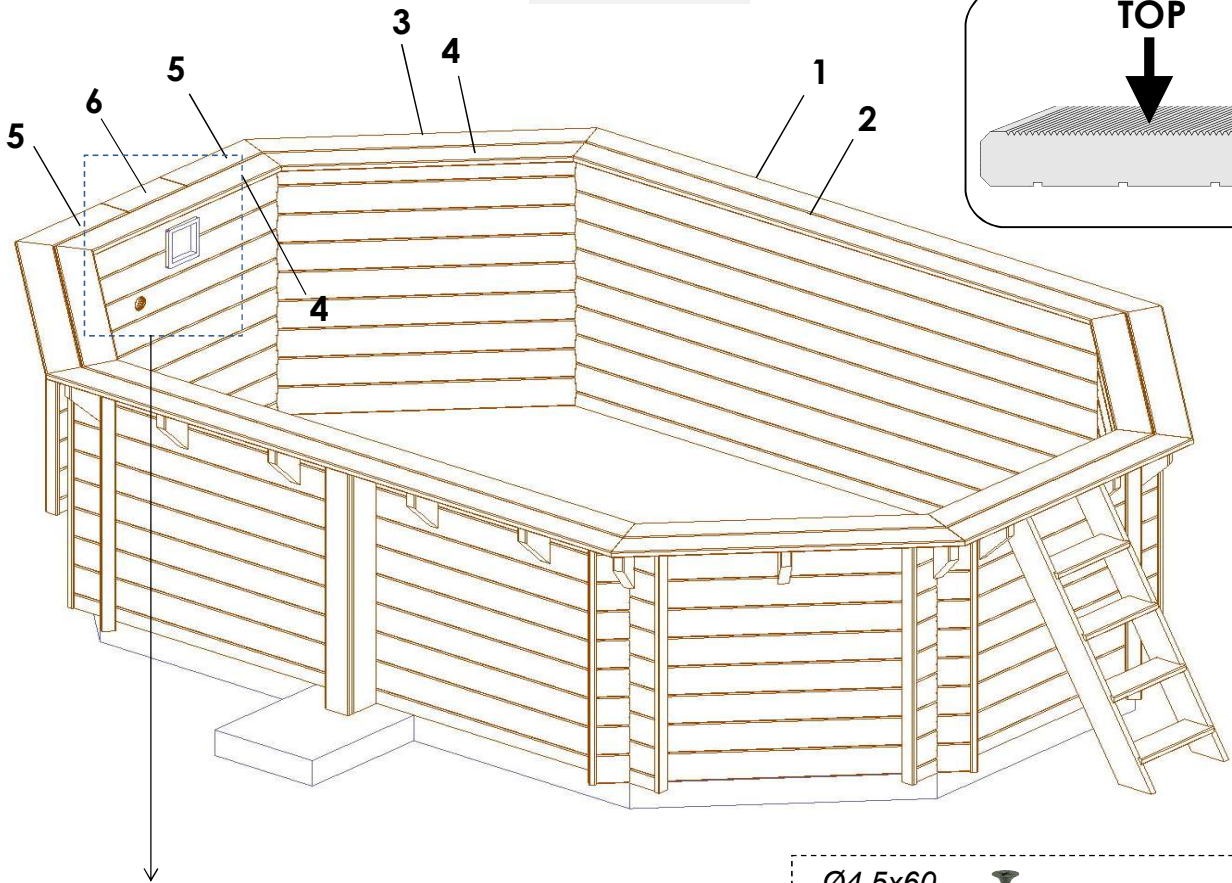

step VI





-  Ø3,0x25 - x12
-  Ø3,5x25 - x138
-  Ø4,5x60 - x28

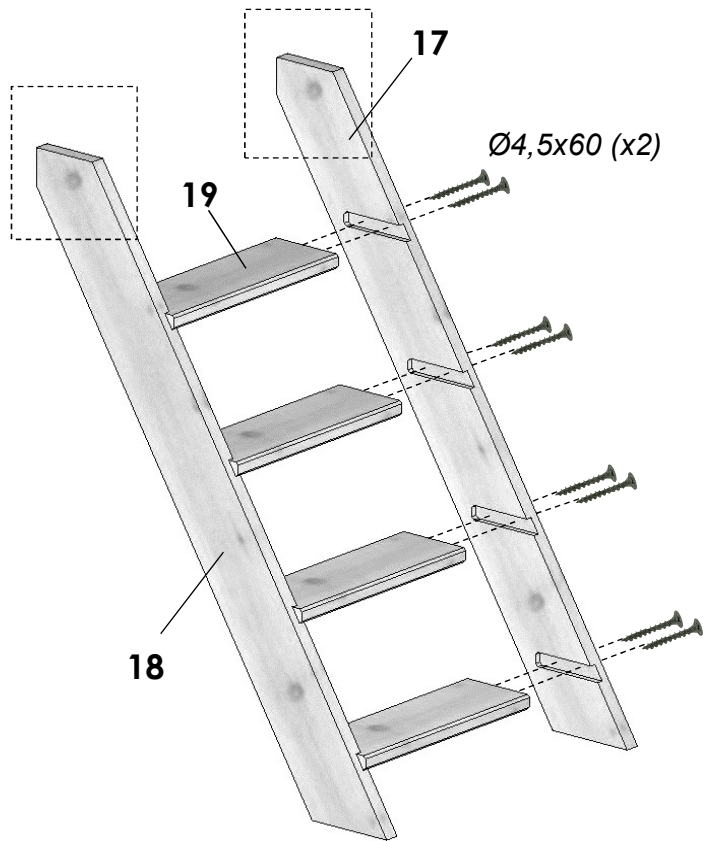
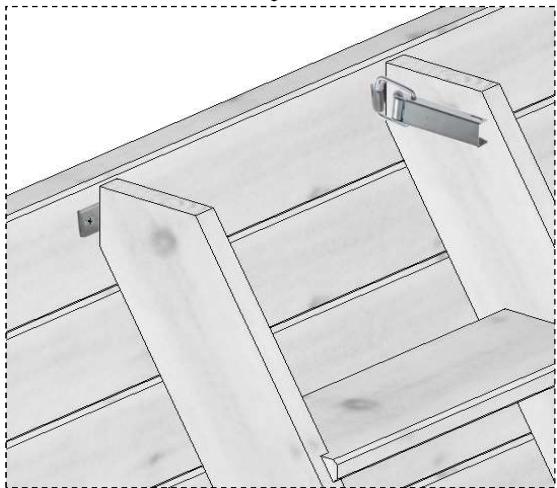
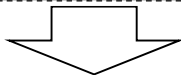
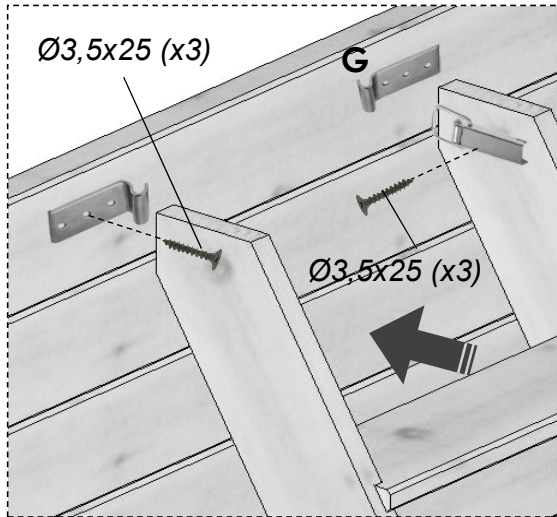

step VII



- | | |
|---|-------------------------------|
|  | $\text{Ø}3,5 \times 25$ - x12 |
|  | $\text{Ø}4,5 \times 60$ - x16 |



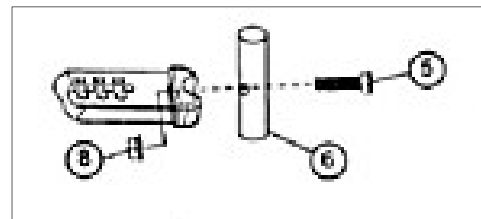
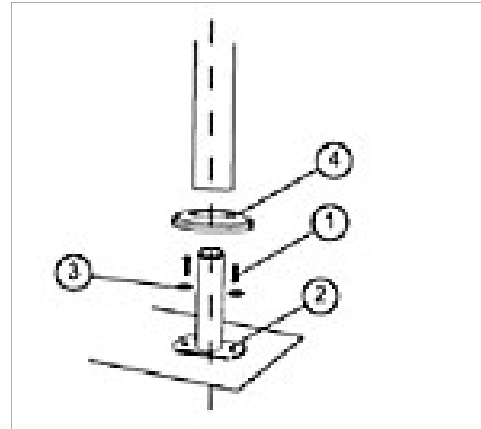
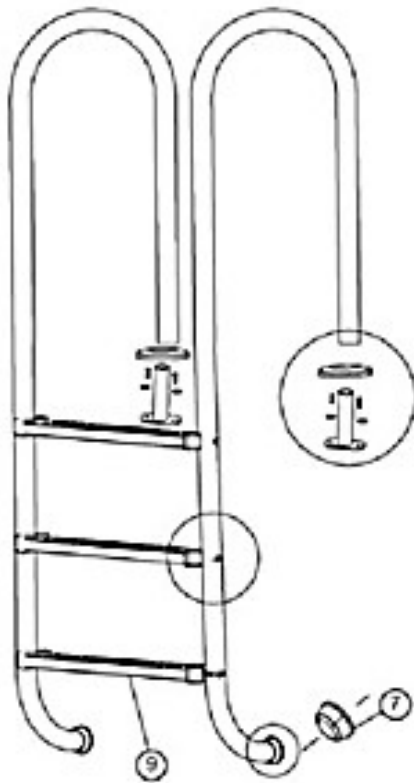

1	Skrews A	x4
2	Clamping foot	x2
3	Washers	x4
4	Overlays	x2
5	Skrews B	x6
6	Brackets	x2
7	Articulated bumpers	x2
8	Nuts	x6
9	Steps	x3



SISTEMA DI FILTRAGGIO

FUNZIONI DELLA VALVOLA DI CONTROLLO:

FILTER - Per il filtraggio standard, impostare la valvola sulla posizione FILTER. Utilizzato anche per l'aspirazione.

BACKWASH – Funzione che consente di pulire il filtro quando il manometro indica una pressione superiore di 8-10 PSI (0,55-0,69 BAR) alla pressione iniziale. Per farlo, spegnere la pompa, impostare la valvola in posizione BACKWASH, avviare la pompa e continuare fino a quando l'acqua non è completamente purificata - l'acqua pulita dovrebbe essere visibile nell'indicatore di trasparenza dell'acqua sul filtro, l'intero processo richiede circa 2 minuti o meno, a seconda del grado inquinamento da sabbia. Quindi risciacquare il filtro (vedi RINSE)

RINSE – Dopo la pulizia, arrestare la pompa e portare la valvola in posizione RINSE. Quindi avviare la pompa e lasciarla funzionare entro 30-60 secondi. Questo trattamento permetterà di rimuovere l'acqua sporca che si è formata dopo la pulizia del filtro. Quindi arrestare la pompa e riportare la valvola in posizione FILTRO per tornare alla funzione di filtraggio standard.

WASTE – Questa funzione consente di svuotare la piscina, abbassare il livello dell'acqua o rimuovere lo sporco direttamente nello scarico durante il funzionamento dell'aspirapolvere, senza passare attraverso il filtro.

RECIRCULATE – L'acqua circola nel circuito idraulico senza passare attraverso il sistema di filtraggio.

CLOSED – Taglia il flusso d'acqua dalla pompa al filtro

WINTER – Posizione temporanea applicabile in inverno

ATTENZIONE

Il kit di filtraggio deve essere posizionato ad una distanza minima di 3,5 m dalla piscina a causa del rischio di scosse elettriche.



ATTENZIONE

Il tubo di alimentazione della pompa deve essere assicurato in conformità ai requisiti per l'uso delle piscine.

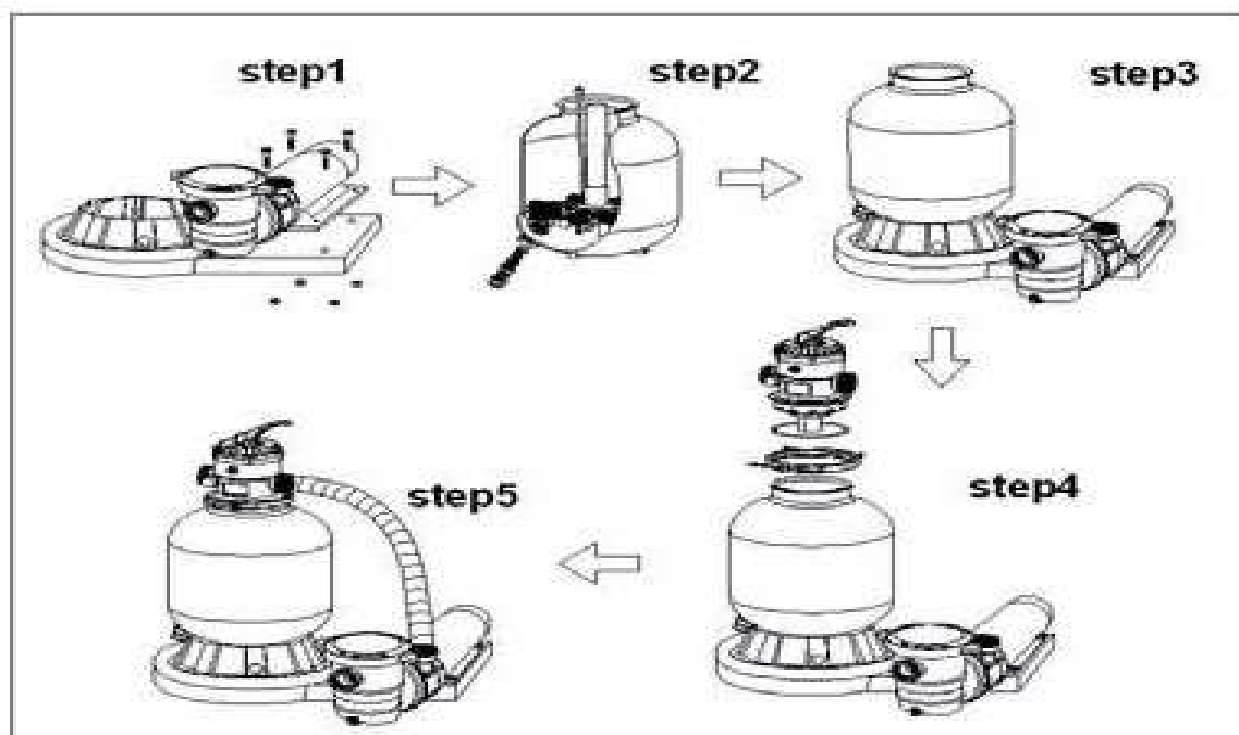

BSVillage
PISCINE - WELLNESS - OUTDOOR

www.bsvillage.com

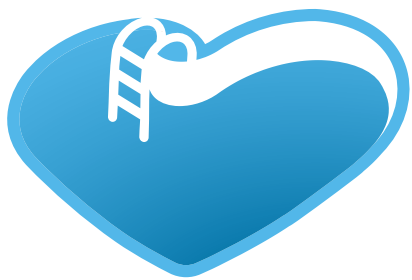

BSVillage
PISCINE - WELLNESS - OUTDOOR

www.bsvillage.com

BUSINESS SHOP S.r.l. a Socio Unico
Via della Repubblica n. 19/1 - 42123 Reggio Emilia (RE)
P.Iva e C.F. 02458850357 - Cap. soc. 60.000,00 € i.v.

 www.bsvillage.com

 0522 15 36 417

 info@bsvillage.com

 0522 18 40 494