

2015/11

918.000.801.00

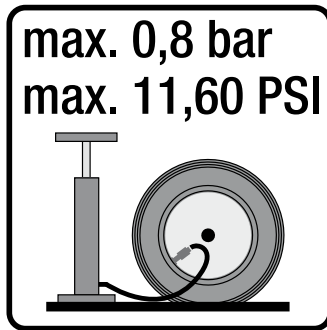

■ made
■ in
■ Germany

JOHN DEERE

John Deere 7930

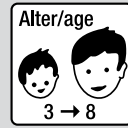

Plattform / Platform
70 *** *, 71 *** *

2018/11

700.000.804.00

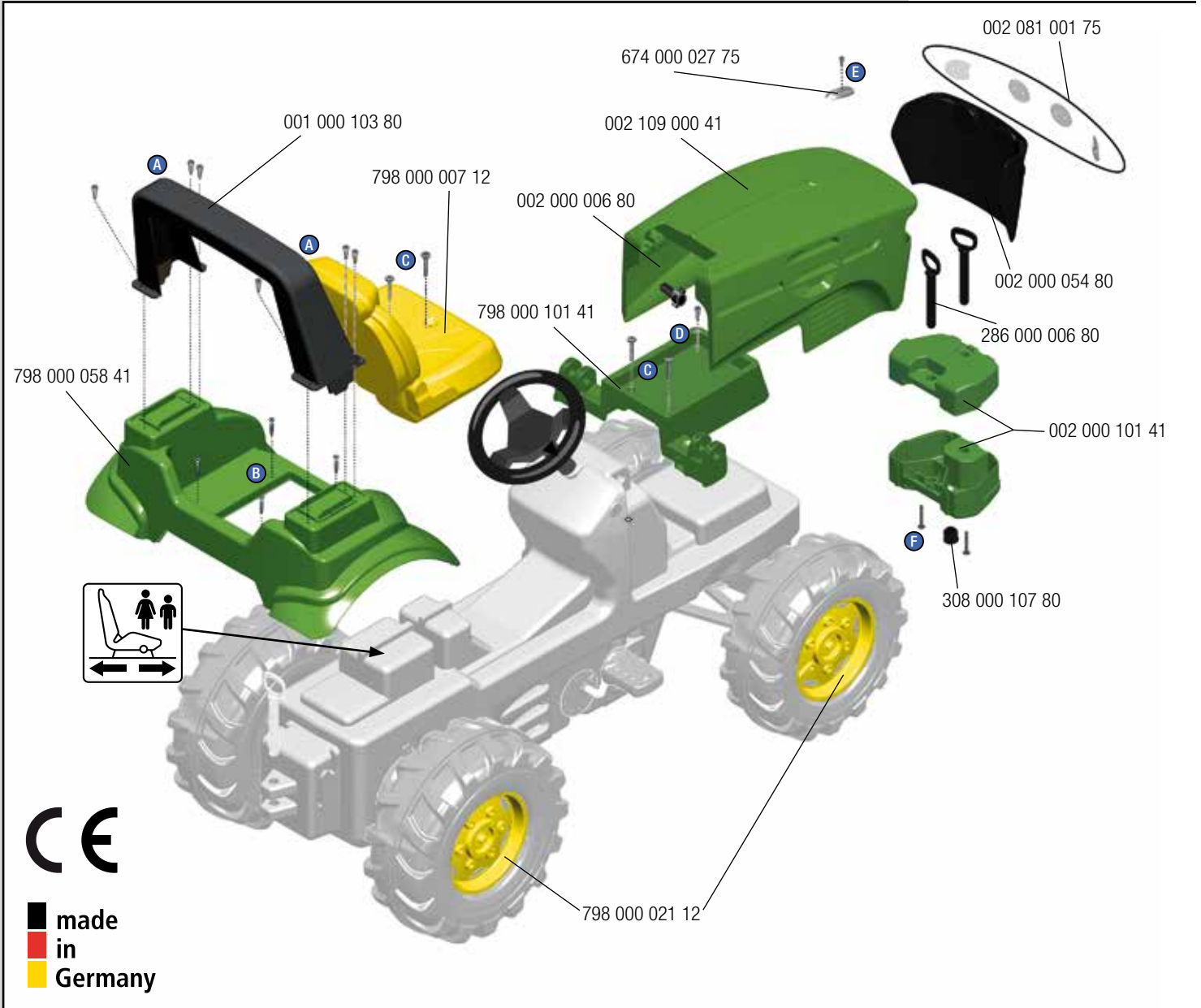

(BG) Предупреждение!	(LT) Įspėjimas!
(CZ) Varování!	(LV) Uzmanību!
(D) Achtung!	(M) Avvisi!
(DK) Advarsel!	(MK) Вниманиe!
(E) Aviso!	(N) OBS!
(EST) Hoiatus!	(NL) Waarschuwing!
(F) Attention!	(P) Aviso!
(FIN) Varoitus!	(PL) Ostrożnie!
(GB) Warning!	(RO) Avertisment!
(GR) Προειδοποίηση!	(RUS) Вниманиe!
(H) Figyelmeztetés!	(S) Varning!
(HR) Pažnja!	(SK) Varovanie!
(I) Avviso!	(SLD) Opozorilo!
(IRL) Rabhchán!	(TR) Dikkat!

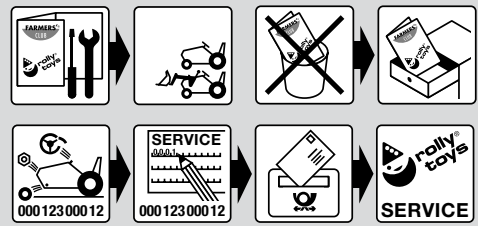

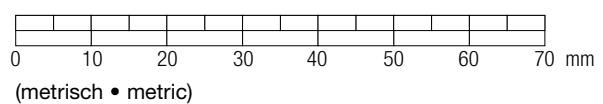
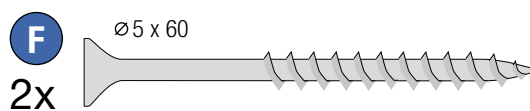
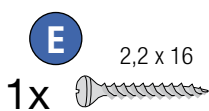
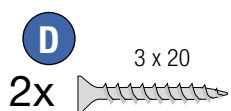
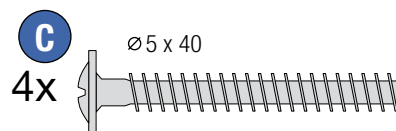
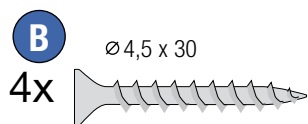
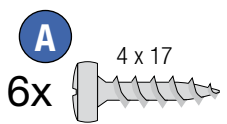
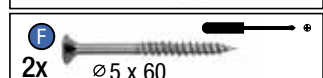
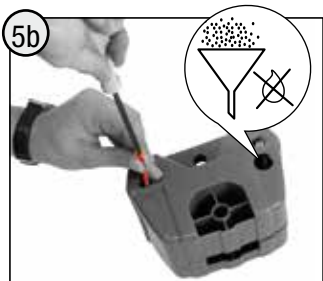
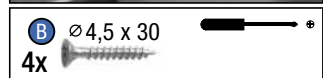
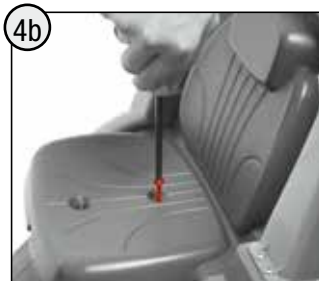
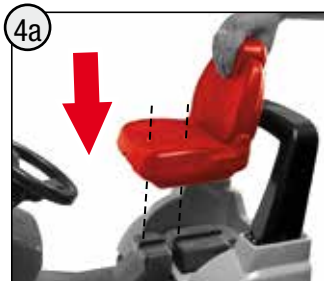
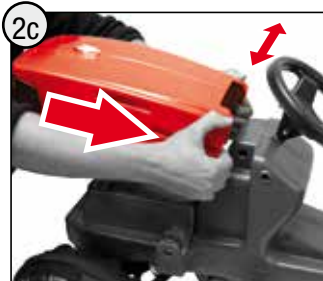
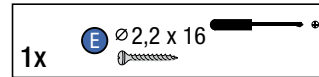
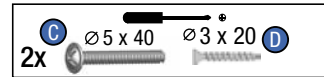
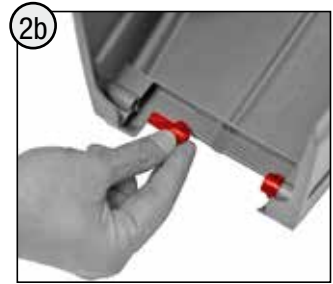
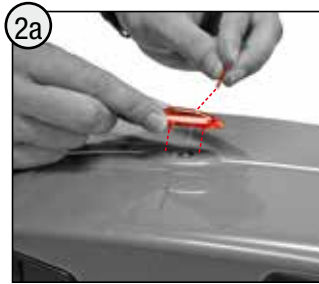
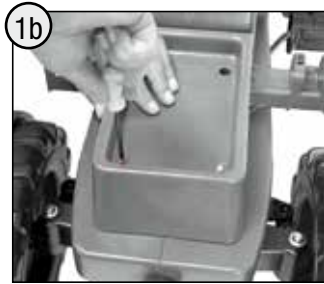
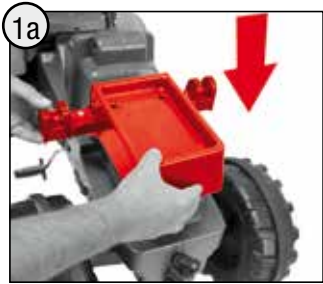

(metrisch • metric)

rolly[®] trac lader

Alter/age
3 → 10



2018/09

934.000.800.00

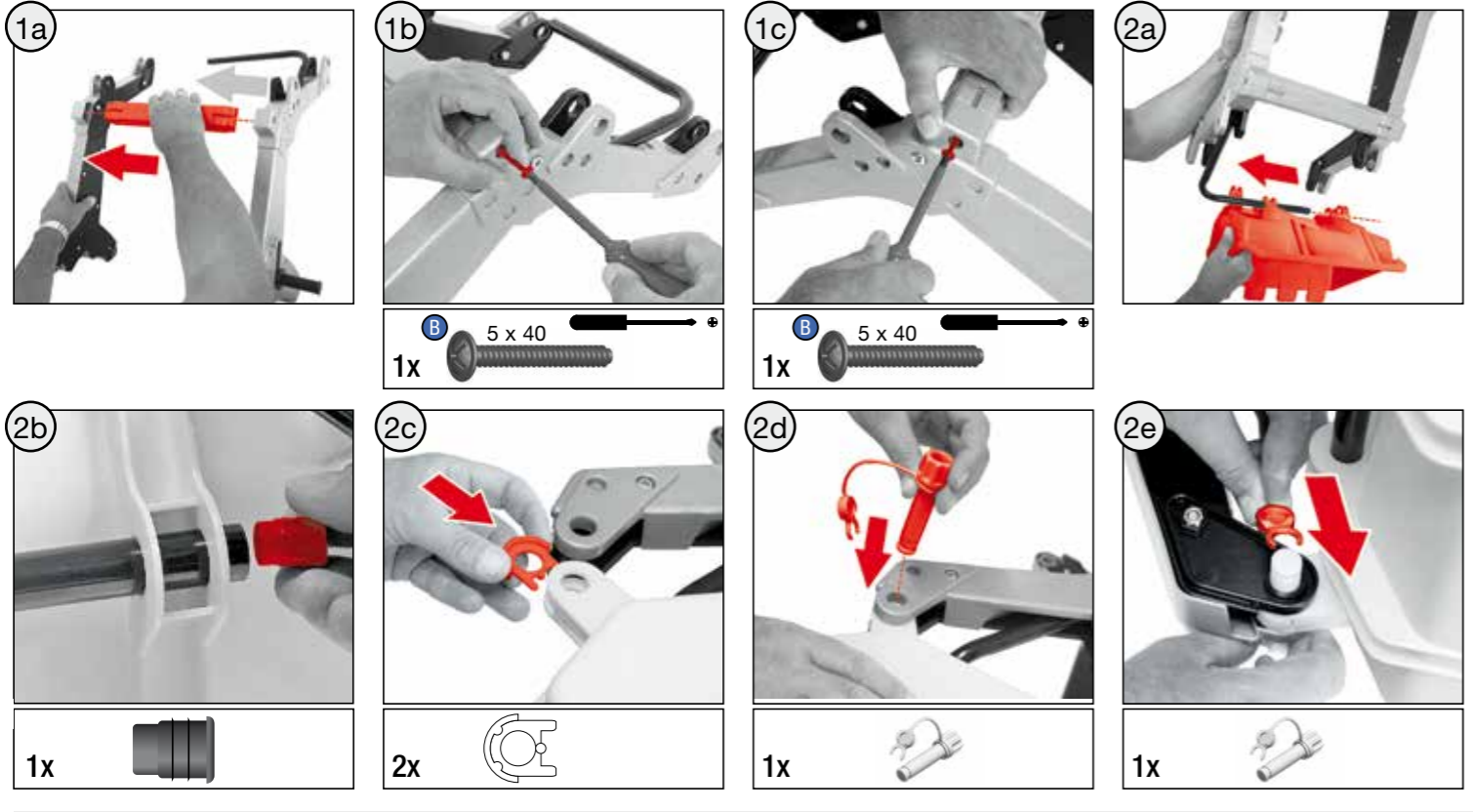

WARNING:
CHOKING HAZARD – Small parts.
Not for children under 3 years.

- CHOKING HAZARD - Small parts, Danger of being swallowed. Contains small parts in non assembled state. Must be assembled by adults.
- Toy is not suitable to carry children.
- If toy is defective stop using it, repairs may only be carried out by adults.
- Adult supervision required.
- Never use near steps, slopes, driveways, hills, roadways, alleys or swimming pool areas.
- Always wear shoes.
- Conforms to the requirements of ASTM Standard Consumer Safety Specification on Toy Safety, F 963.

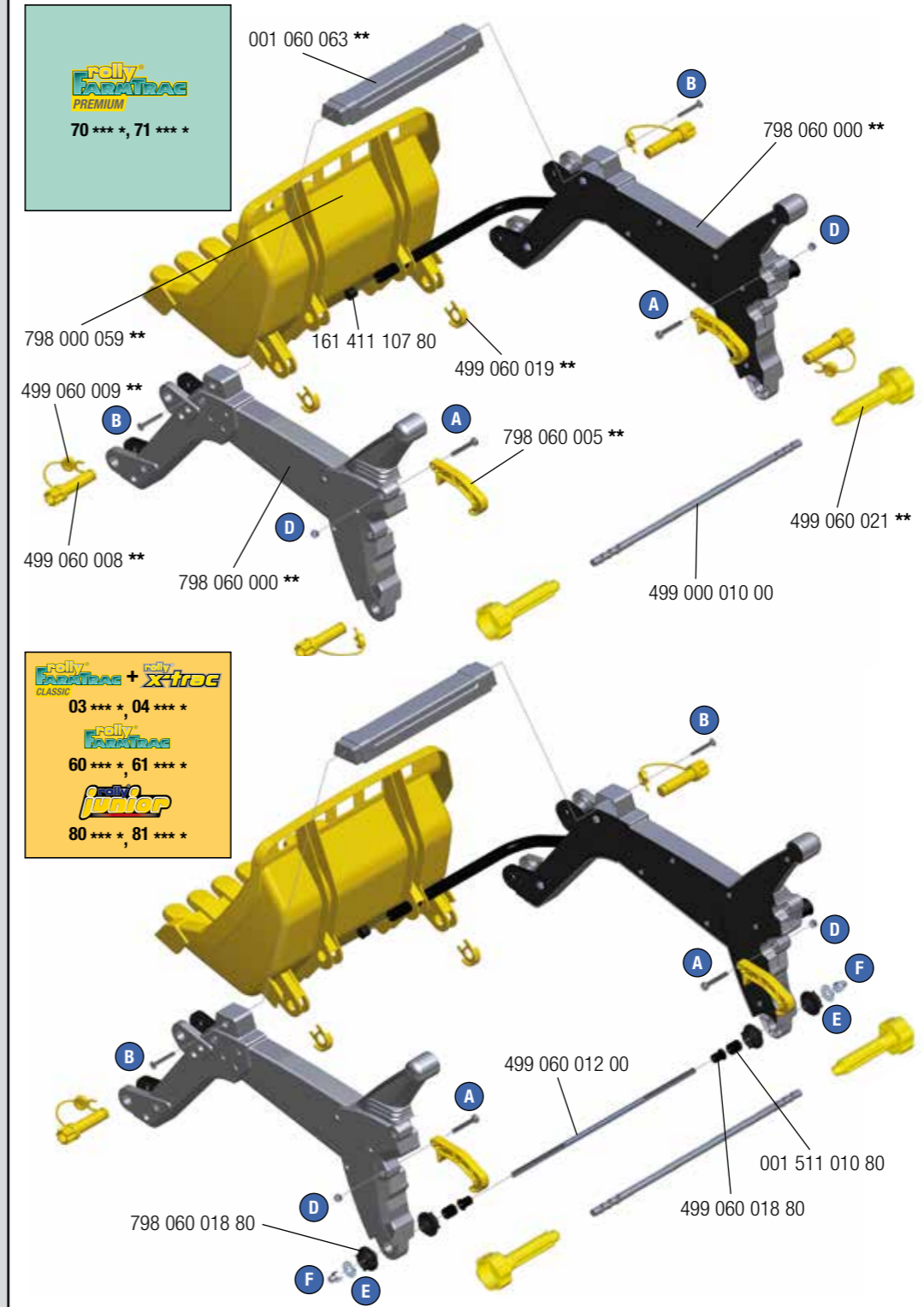
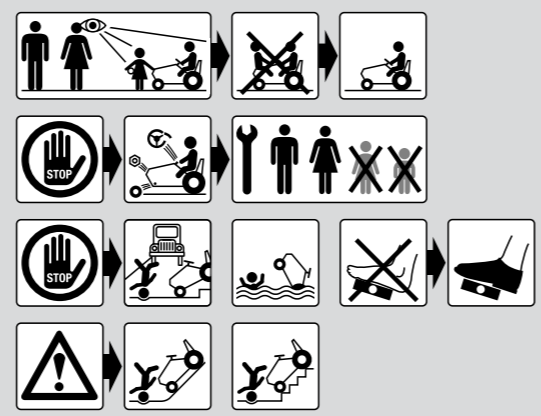

rolly[®] FABRITAC + XTROE
CLASSIC
03 *** , 04 ***
60 *** , 61 ***
rolly[®] JUNIOR
80 *** , 81 ***

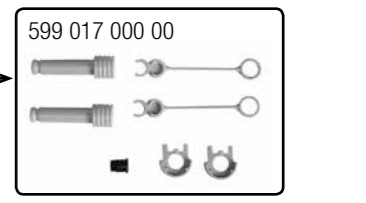
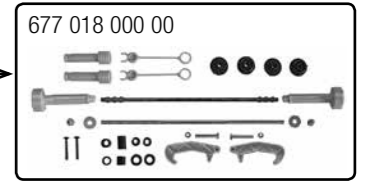

→ **

● +10	● +26	● +47
● +12	● +30	● +51
● +13	● +37	● +54
● +20	● +40	● +70
● +22	● +41	● +75
● +23	● +44	● +80

--- NORTH & SOUTH AMERICA only ---
180 days warranty
From the date of purchase + guaranteed spare part service
The warranty does not cover damages caused by improper use or neglect

CE
made in Germany

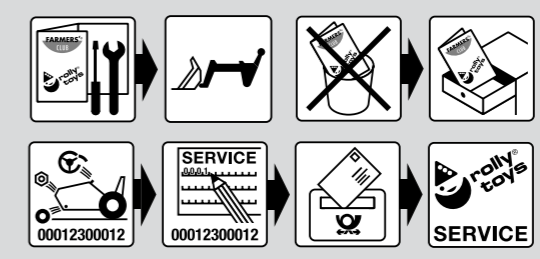

rely[®]
FARATRAC
PREMIUM
70 *** , 71 ***
(A - I)

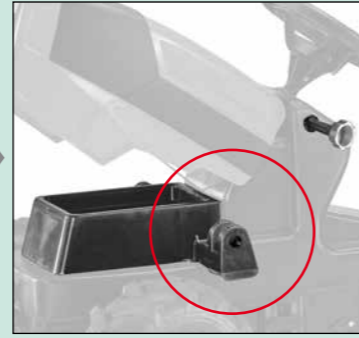
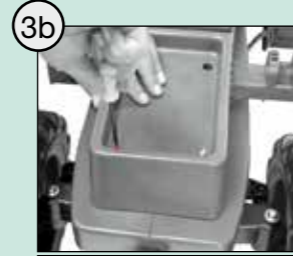
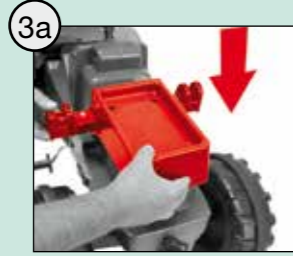

2x **B** 5 x 40
2x **C** 3 x 20

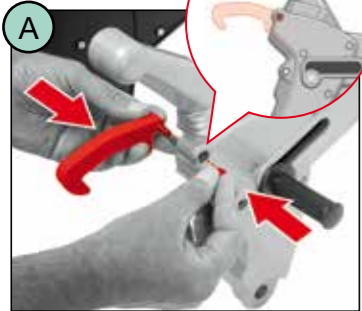

1x **A** M6 x 40
1x **D** M6

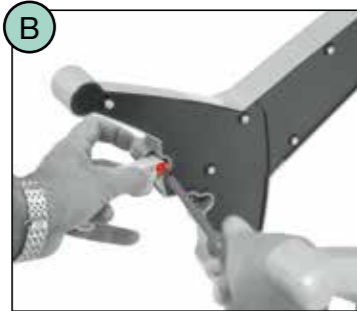

1x

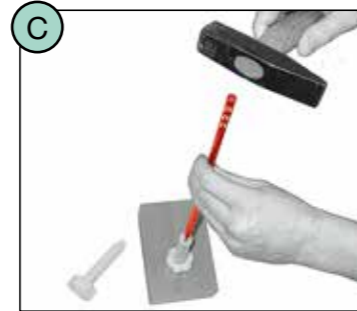

1x $\varnothing 8 \times 335\text{mm}$

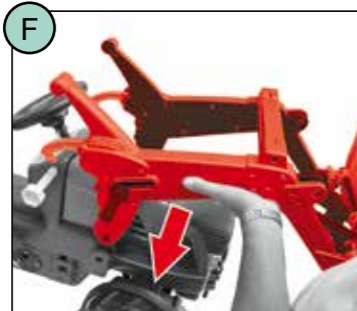
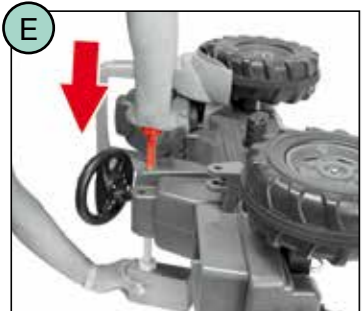
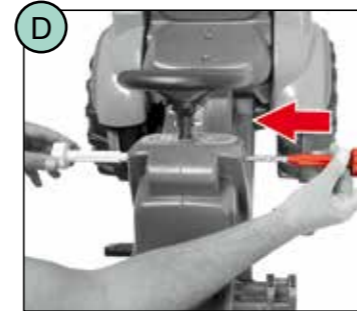

2x

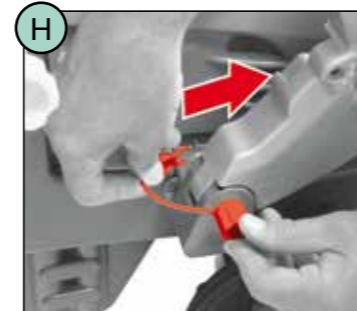

rely[®]
FARATRAC + **rely[®]**
CLASSIC **XTRAC**
03 *** , 04 ***
rely[®]
FARATRAC
60 *** , 61 ***
rely[®]
junior
80 *** , 81 ***
(J - Z)

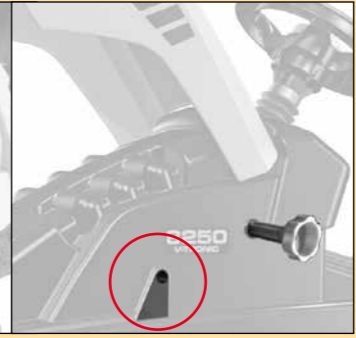
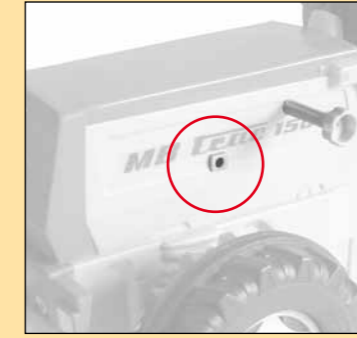

1x **A** M6 x 40
1x **D** M6

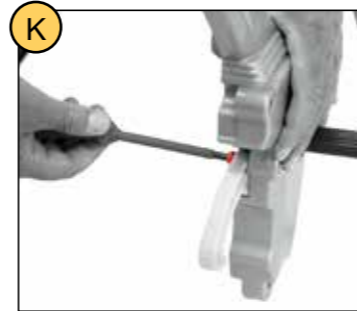

1x

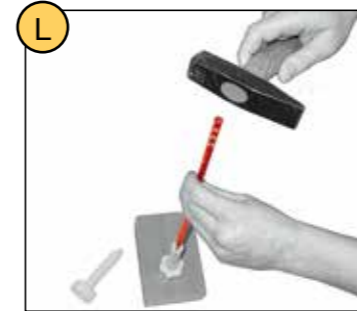

1x $\varnothing 8 \times 335\text{mm}$

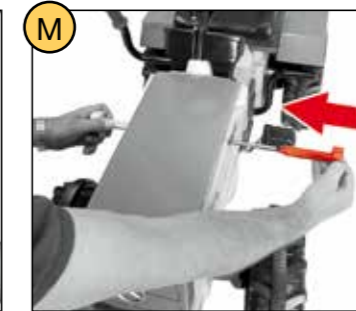

1x

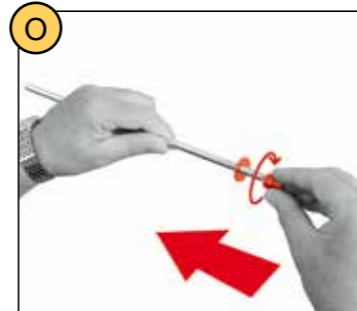
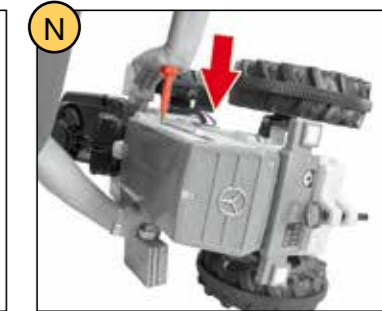

1x $\varnothing 8 \times 345\text{mm}$



2x $\varnothing 12 \times 16\text{mm}$

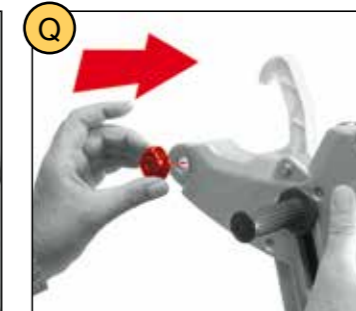

1x



1x

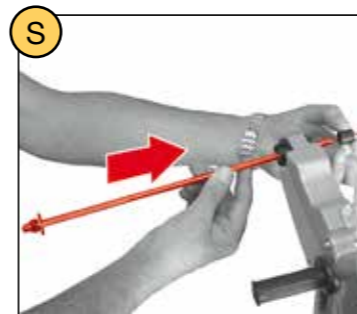

1x

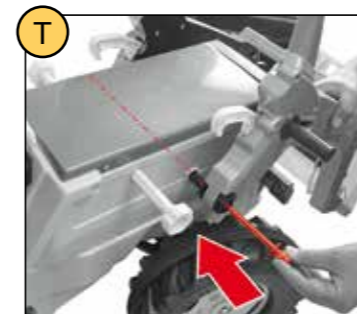

1x

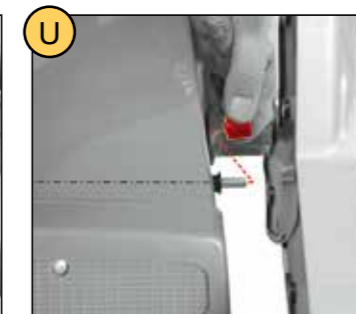

1x

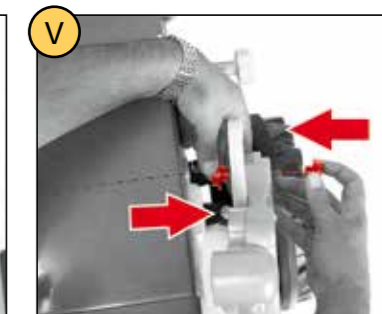

1x



1x $\varnothing 8,4 \times \varnothing 24$

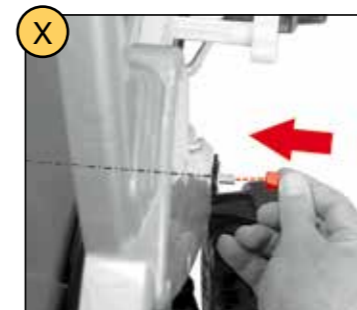

1x M8

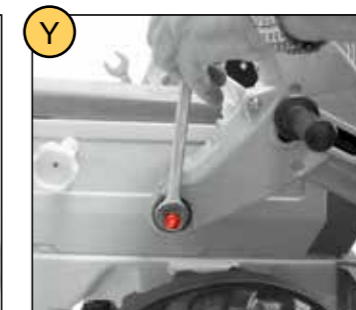

1x 13



A M6 x 40
2x 798 506 040 00

D M6
2x 098 506 000 00

E $\varnothing 8,4 \times \varnothing 24$
2x 902 184 000 00
F M8
2x 098 608 000 00

B AMTEC 5 x 40
2x 520 060 540 00

C $\varnothing 3 \times 20$
2x 750 503 020 00

0 10 20 30 40 50 mm (metrisch • metric)

Plattform / Platform

70 *** *, 71 *** *

2018/09

700.000.803.00

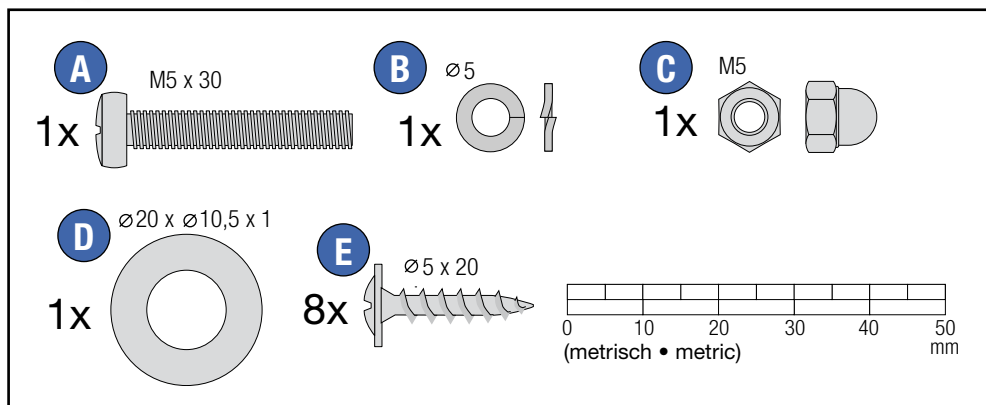
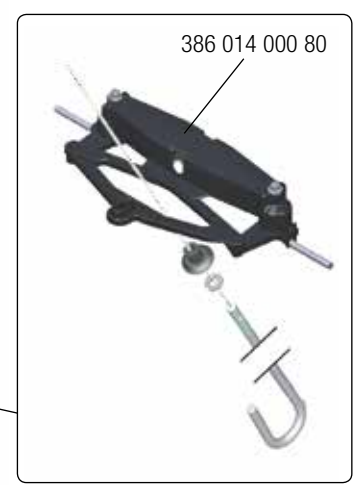
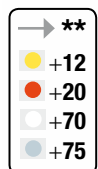
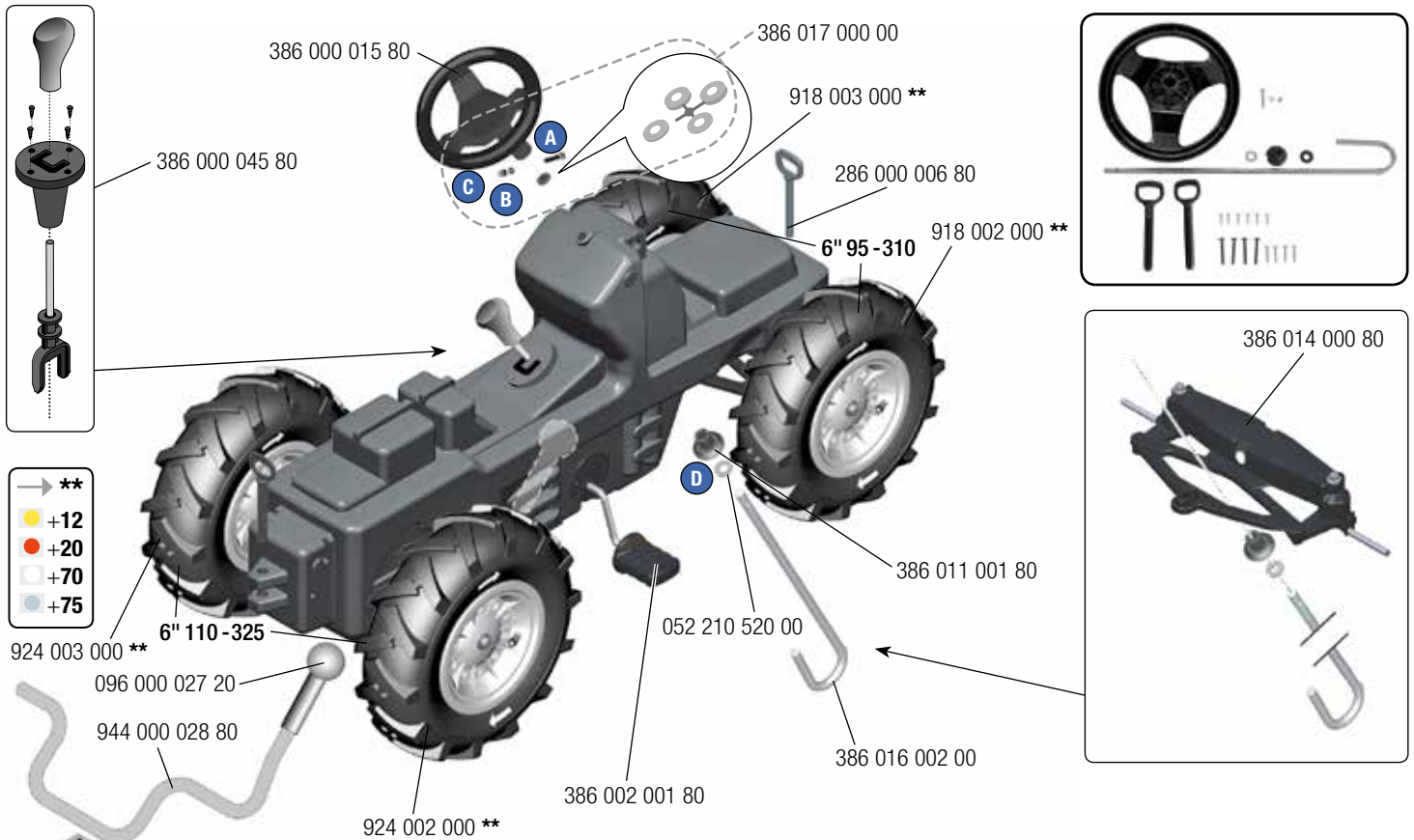

BG Предупреждение!	LT Įspėjimas!
CZ Varování!	LV Uzmanību!
D Achtung!	M Avvis!
DK Advarsel!	MK Внимание!
E Aviso!	N OBS!
EST Hoiatus!	NL Waarschuwing!
F Attention!	P Aviso!
FIN Varoitus!	PL Ostrożnie!
GB Warning!	RO Avertisment!
GR Προσοχή!	RUS Внимание!
H Figyelmeztetés!	S Varning!
HR Pažnja!	SK Varovanie!
I Avviso!	SLO Opozorilo!
IRL Rabhchán!	TR Dikkat!

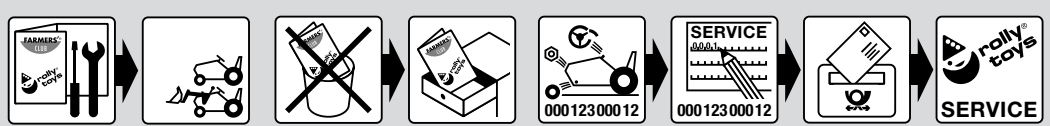

WARNING:
CHOKING HAZARD – Small parts.
Not for children under 3 years.

made in Germany

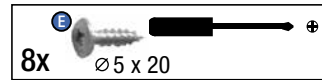
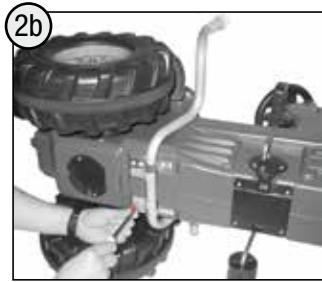
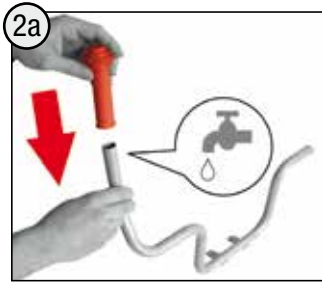
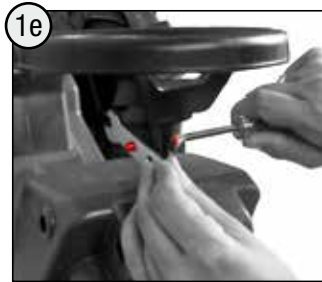
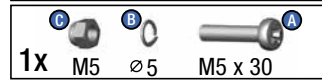
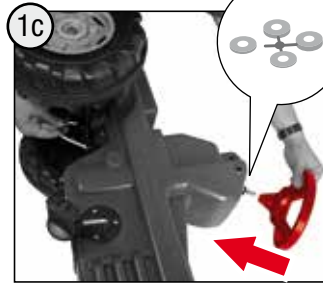
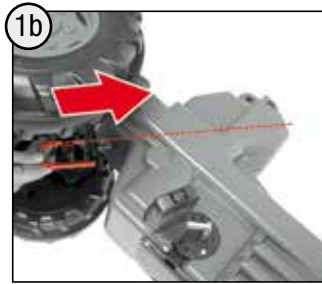
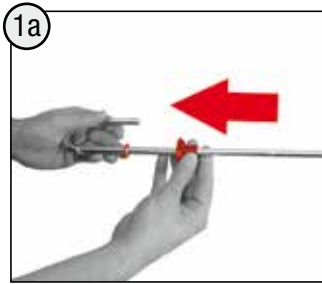

---NORTH & SOUTH AMERICA only---

180 days warranty

From the date of purchase + guaranteed spare part service
The warranty does not cover damages caused by improper use or neglect

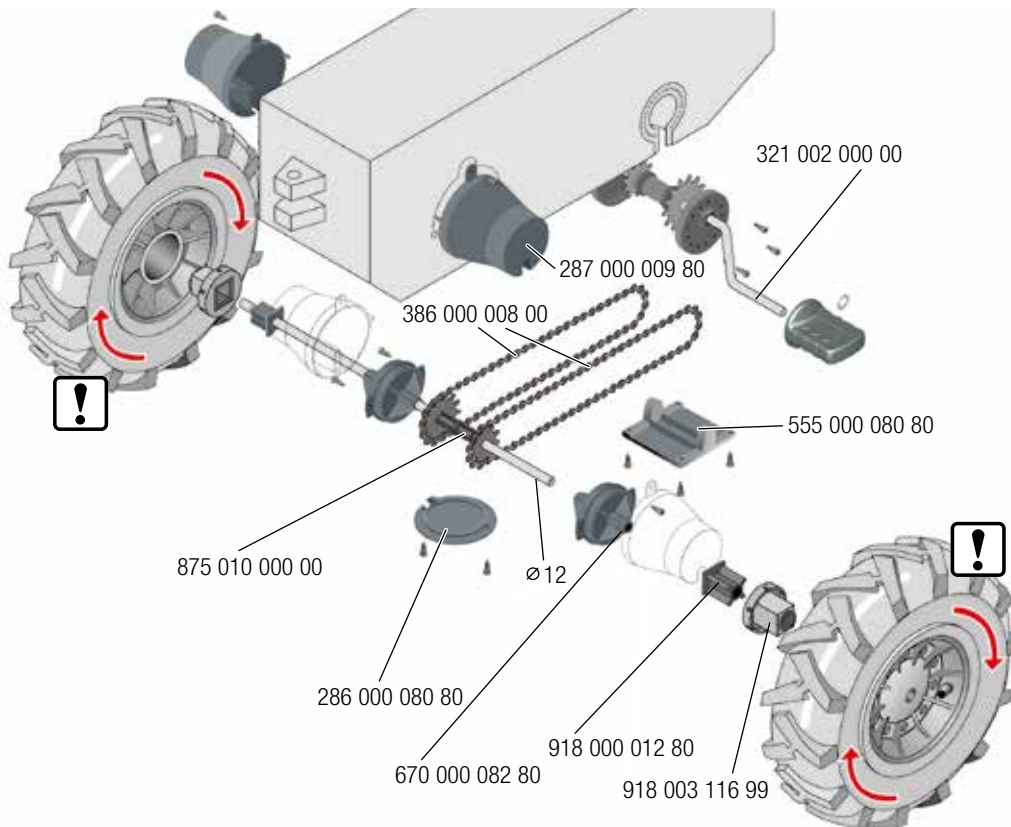

WARNING

- **CHOKING HAZARD:** Small parts. Danger of being swallowed. Contains small parts in non assembled state. Must be assembled by adults.
- Adult supervision required.
- Never use near steps, slopes, driveways, hills, roadways, alleys or swimming pool areas.
- Always wear shoes.
- Never allow more than one rider.
- The use of protective gear and a safety helmet is highly recommended.
- Conforms to the requirements of ASTM Standard Consumer Safety Specification on Toy Safety, F 963
- Not suitable for children under 3 years.