

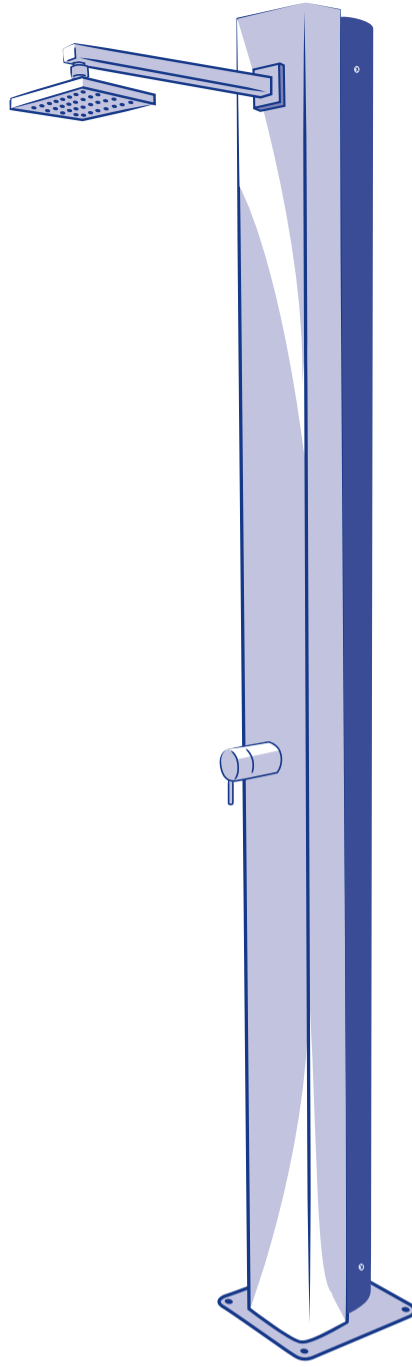

- We reserve the right to change all or part of the articles or contents of this document, without prior notice.
- Nos nous réservons le droit de modifier totalement ou en partie les caractéristiques de nos articles ou de le contenu de ce document sans pré-avis.
- Nos reservamos el derecho de cambiar total o parcialmente las características de nuestros artículos o contenido de este documento sin previo aviso.
- Ci riserviamo il diritto, senza preavviso, di cambiare, totalmente o parzialmente, il contenuto di questo documento.
- Wir behalten uns das recht vor die merkmale unserer produkte und den inhalt dieser beschreibung ohne vorherige ankündigung ganz oder teilweise zu ändern.
- Reservamo-nos ao direito de alterar, total ou parcialmente as características dos nossos artigos ou o conteúdo deste documento sem aviso prévio.
- We behouden het recht om alle artikelen of een gedeelte van de artikelen en/of de inhoud van dit document te veranderen, zonder voorgaande verwittiging.
- Vi forbeholder oss retten til å endre hele dokumentet eller enkelte avsnitt av dokumentet uten forvarsel.
- Vi forbeholder os retten til at ændre hele dokumentet eller enkelte afsnit uden forudgående varsel.
- Vi förbehåller oss rätten till att ändra hela dokumenter eller delar av det, utan förvarning.
- Pidätämme oikeuden muuttaa kokonaan tai osittain tämän asiakirjan tietoja ilman ennakoilmoitusta.
- Zastrzegamy sobie prawo zmiany urządzenia lub jego części, oraz zawartości tego dokumentu bez wcześniejszego powiadomienia.
- Мы оставляем за собой право частично или полностью изменять характеристики наших изделий или содержание данного документа без предварительного уведомления.
- Onceden haber vermaksizin maddelerin tümünü ya da bir bölümünü ya da bu dokümana ait içerigi degistirme hakkini isakli tutariz.
- Ne rezervam dreptul de a schimba o parte sau toate produsele aferente documentului, fara o notificare in prealabil
- Запазваме си правото да променяме всички или част от артикулите или съдържанието на този документ, без предварително известие.
- Fenntartjuk a jogot termékeink tulajdonságainak illetve e dokumentum tartalmának részleges vagy teljes megváltoztatására, előzetes figyelmeztetés nélkül.
- Vyhradzujeme si právo zmeniť zozna alebo čiastočne charakteristiky našich výrobkov alebo obsah tohoto dokumentu bez predchozieho upozornenia.
- Διατηρούμε το δικαίωμα αλλαγής μέρους ή του συνόλου των όρων ή των περιεχομένων αυτού του εγγράφου χωρίς καμία προειδοποίηση
- نحتفظ بكل حقنا في تغيير كل أو جزء من خصائص منتجاتنا و محتوى دليل منتجاتنا دون اشعار مسبق
- 在没有预先通知的情况下，我们保留更改全部或部分内容的权利。

53873E201-02
034.12.01



1

- x 1
- x 1
- x 1

x 1

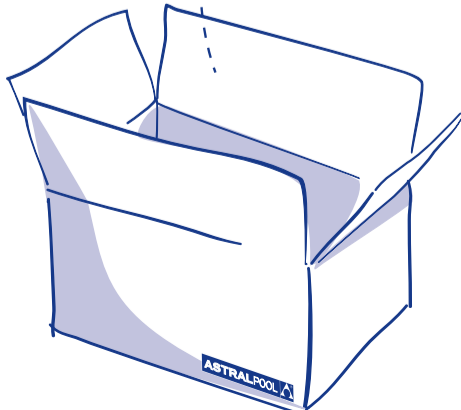

2

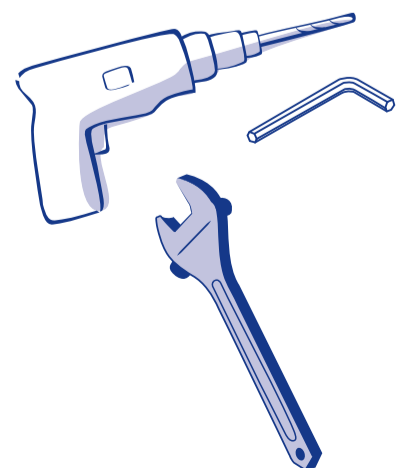

3

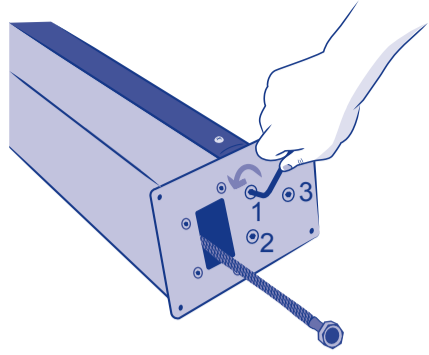

3.1

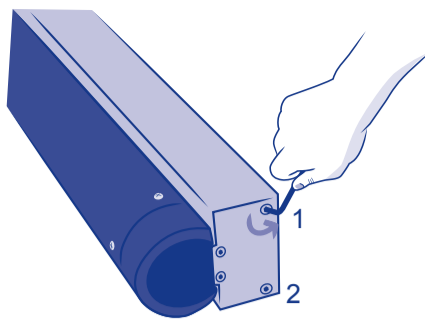

3.2

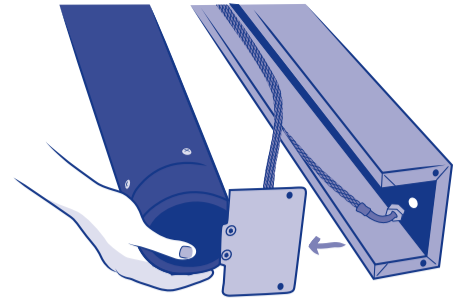

3.3

4

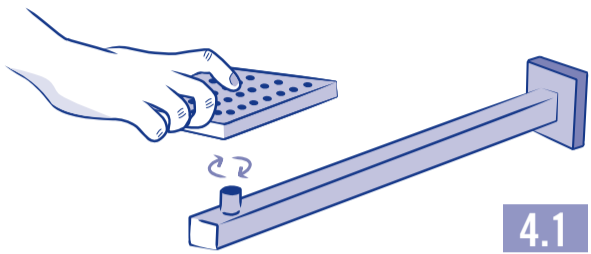

4.1

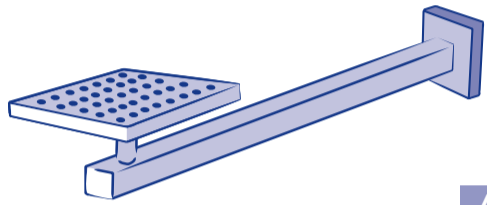

4.2

5

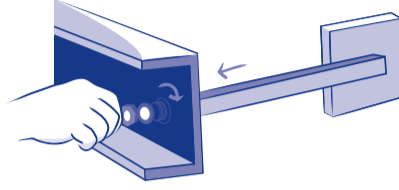

5.1

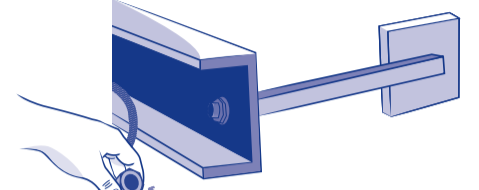

5.2

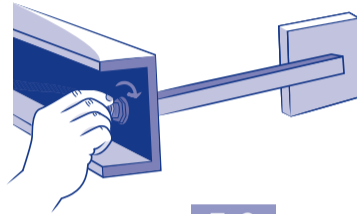

5.3

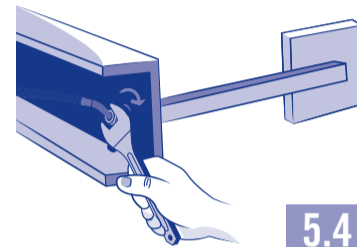

5.4

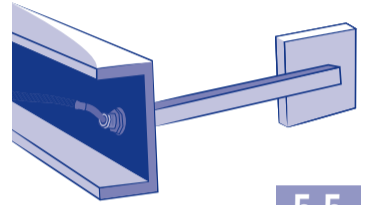

5.5

6

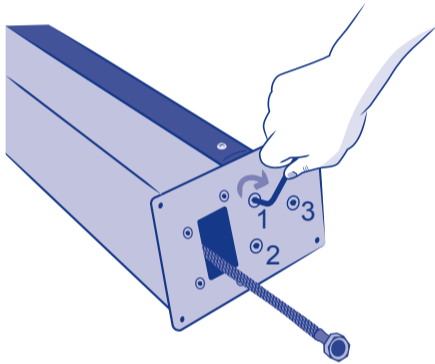

6.1

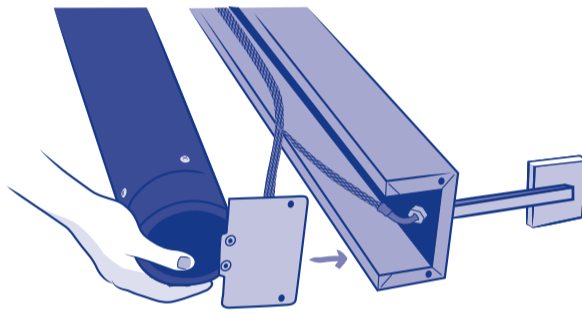

6.2

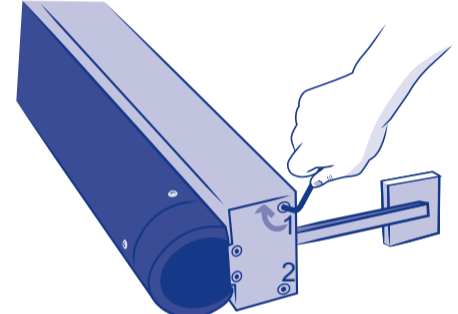

6.3

7

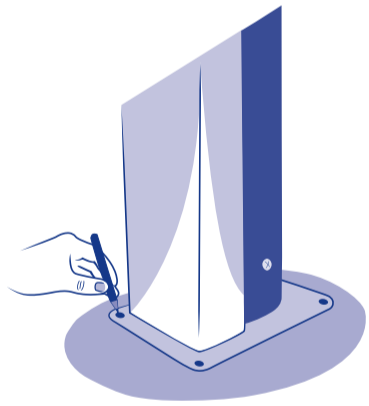

7.1

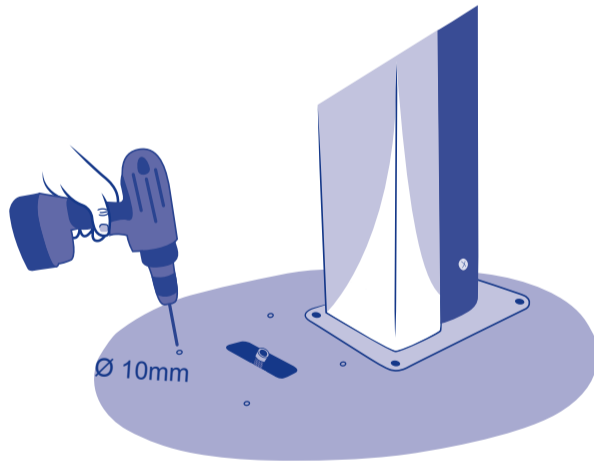

7.2

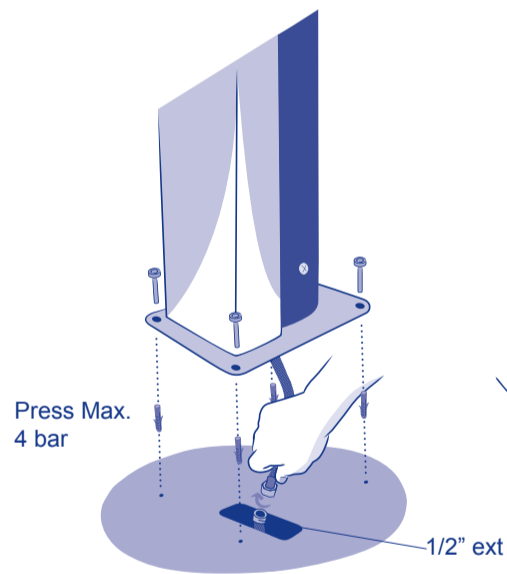

7.3

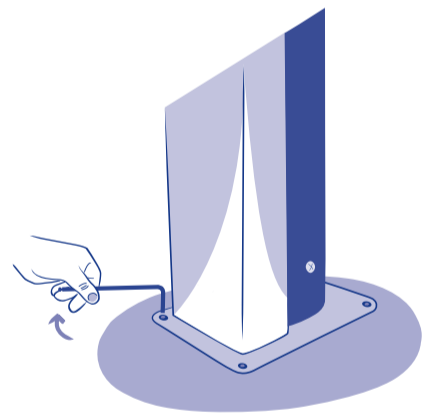

7.4

8

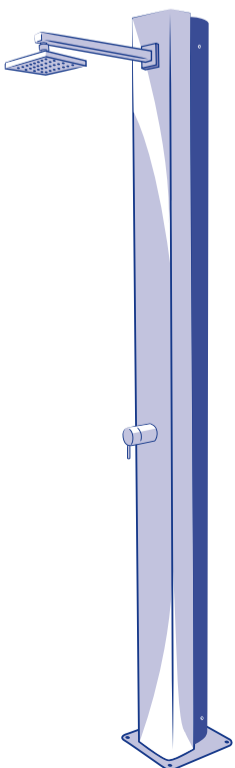

9

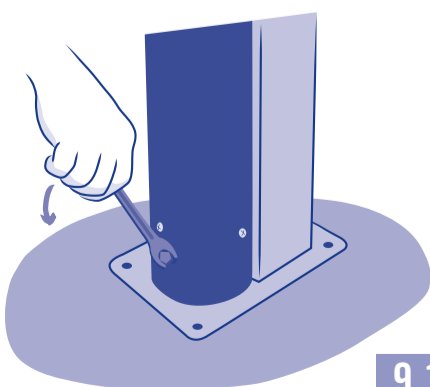
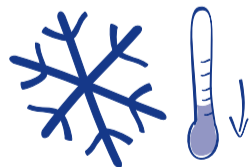

9.1

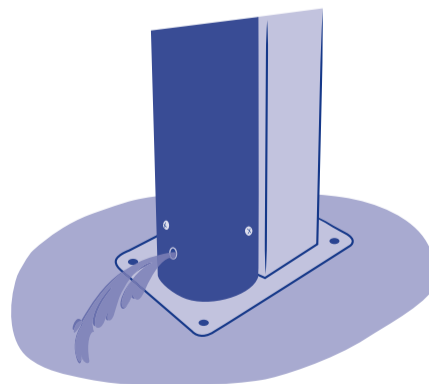

9.2

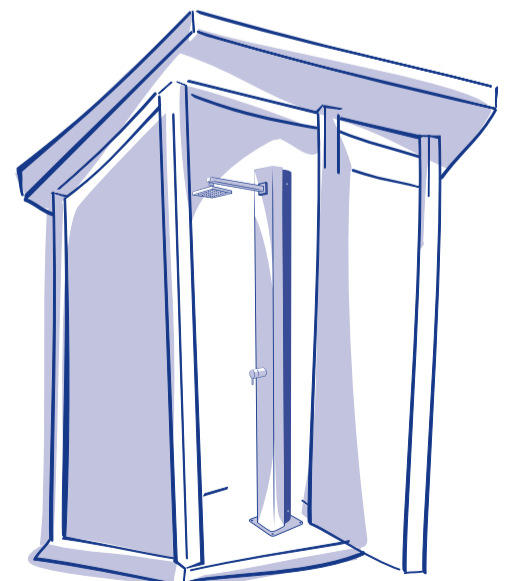

9.3